



Induction hob 5000 'Electric'

DESCRIPTION	MODULAR	
	800	900
B-E4IND 5000	V03605	V03607
R-E4IND 5000	V03604	V03606
1/2R-E2IND 5000	V03598	V03600
1/2B-E2IND 5000	V03599	V03601



Installation manual





Induction hob 5000 'Electric'

CONTENTS

INSTALLATION MANUAL.....	1
‘COMPLIANCE WITH FRENCH DECREE NO. 2005-829 OF 20 JULY 2005’	1
1. INSTALLATION.....	3
1.1. GENERAL POINTS	3
1.2. HANDLING - POSITIONING	3
1.3. INSTALLATION	3
WARNINGS	3
1.4. DATA PLATE.....	4
2. ELECTRICAL CONNECTION.....	4
2.1. CHECKS BEFORE CONNECTION.	4
2.2. CONNECTING THE APPLIANCE TO THE ELECTRICITY SUPPLY	5
2.3. CHECKS AFTER CONNECTION	5
2.4. TABLE OF ADAPTATIONS TO DIFFERENT SUPPLY VOLTAGES.....	5
3. APPLIANCE WIRING DIAGRAMS	6
INDUCTION GENERATOR.....	8
4. LIST OF EMERGENCY PARTS.	11
5. PROBLEMS.....	12
USER MANUAL	14
‘COMPLIANCE WITH FRENCH DECREE NO. 2005-829 OF 20 JULY 2005’	16
1. INTRODUCTION:.....	17
2. STARTING UP FOR THE FIRST TIME	18
2.1. CONTROL PANEL:.....	18
3. STARTING UP	19
3.1. INDUCTION:.....	19
3.1. ERROR INDICATOR LIGHT	20
3.2. INDUCTION PLATE 5000	20
4. TURNING THE APPLIANCE OFF	21
5. CLEANING.....	21
5.1. CLEANING THE STAINLESS STEEL SURFACES:	21
5.2. CLEANING THE GLASS CERAMIC PLATE	21
5.3. CLEANING THE AIR FILTER	22
6. PROBLEMS.....	22

‘Compliance with French Decree No. 2005-829 of 20 July 2005’
Exclusively for France

A - In accordance with Article 18 of Decree No. 2005-829 of 20 July 2005 on the disposal of waste electrical and electronic equipment, the Paul CHARVET company takes responsibility for the financing and organisation of the disposal of its waste. As such, the Paul CHARVET company resumes full ownership of the electrical and electronic equipment at the end of its life. The equipment should be palletised and ready for loading in a place that is accessible by the carrier. Except in exceptional circumstances, the equipment shall in no case have been dismantled, even partially, otherwise CHARVET reserves the right to re-invoice the costs of processing and taking responsibility for the equipment.

B- How WEEE is disposed of:

The terms and conditions of disposal are covered by the SYNEG/RECYSTEM-PRO agreement, which states that: "In order to fulfil their obligations, the producers of electrical and electronic equipment for large kitchens grouped within the SYNEG, have implemented arrangements for the collection and processing/recycling of WEEE in accordance with the provisions of the decree.

Materials or substances harmful to the environment (such as refrigerants or foams) are extracted or separated. The metal fractions (stainless steel, zinc, copper, etc.) are crushed and transported to refiners for reuse.

Therefore, when you need to have electrical equipment collected by a SYNEG professional kitchen equipment manufacturer, you must contact RECYS'TEM-PRO, the operator chosen for the management of WEEE

➔ at this telephone number: 01 45 01 71 43.

➔ or at the following e-mail address: synergdeee@recystempro.com

You will then be sent a collection request sheet which will contain the following elements:

- name of the producer of the equipment
- type of equipment
- estimated weight
- place of collection
- name and contact details of the installer
- invoicing address

After verification with the producer and obtaining its agreement, RECYS'TEM-PRO will proceed with the collection."

1. INSTALLATION

1.1. General points

The equipment must be installed in a room with adequate ventilation, equipped with an air extraction system, according to the regulations and standards in force in the country of installation and the instructions contained in this manual.

The user manual must be handed over to the user after installation.

1.2. Handling - Positioning

The appliance must remain on its wooden pallet during the handling process until the final installation. Unpack and check the appliance for damage upon receipt.

In case of damage, detail it immediately on the delivery note; notify the carrier by registered mail with acknowledgement of receipt within 48 hours.

1.3. Installation

Special attention should be paid to the local fire prevention regulations of the establishment (see regulations applicable to establishments that are open to the public.)

The appliance must be installed under an extraction hood.

If the appliance is to be installed against a wall or partition, near a piece of furniture or decorative borders, these must be made of fireproof material.

If this is not the case, they must be protected by an approved fireproof, insulating material.

In case of doubt regarding materials, allow a 10 cm space around your appliance from them.

Remove all protective plastic wrapping from the outer panels.

Install the appliance in its place of use.

Warnings



- **Fixed appliance:**

Fit the legs or adjusting bolts (these are delivered in a separate box).

Level the appliance by adjusting the height of the legs to obtain the height of the horizontal worktop.

- **Mobile appliance:**

Fit the castors (these are delivered in a separate box.)

The brakes on the castors must be in locked position when the appliance is in position for connection and when the cooking function is in operation.

Interventions:

**Any intervention or repair on an appliance must be undertaken by a qualified installer.
The appliance will be isolated from the electrical power supply and locked out/tagged out for the duration of the intervention.**

When the installation is complete, train users on the proper use of the appliance (see the user manual).

Warranty: The warranty is part of the sale contract.

It does not cover any damages due to faulty installation, misuse or inadequate maintenance.

1.4. **Data plate**

Each appliance has a data plate. Record the information on the appliance's data plate in the part of the manual reserved for that purpose (see last page). This will make it easier for you to communicate with your customer for better service delivery.

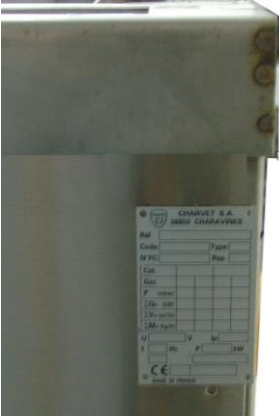
	
<p align="center">Position of the plate on the open cabinet of the Induction 5000</p>	<p align="center">Position of the plate on the hob of the Induction 5000</p>

2. ELECTRICAL CONNECTION

Warnings



**The appliance must be earthed.
It is dangerous to put the appliance into service without connecting it to earth.
Our liability cannot be incurred in the event of accidents resulting from non-existent or incorrect earthing.**

• **Mobile appliance:**

Ensure that the user's fixed installation has an all-pole circuit breaker with point gap of 3.5mm in compliance with standard EN 60335-1. The appliance is connected by a cable with a socket plug suitable for the power. This socket must be accessible at all times.

• **CAUTION:**

Use standard cable (245 IEC 57 or 245 IEC 66) or other cables with the same characteristics.

2.1. **Checks before connection.**

All the checks and inspections below are carried out when the appliance is switched off and cold.

Check:

- That the electrical voltage of the supply is compatible with the voltage and wattage of the appliance (see § 5).
- Check that the cable is fixed correctly.
- Check that the appliance's connections are tight.
- Check that the cable section is compatible with the voltage of the appliance.

2.2. **Connecting the appliance to the electricity supply**

Electrical induction:

- Remove the front cover to access the junction box. (screw fixing), then pull the bottom towards you and down to remove the top part.
- The junction box is in front of you.
- Remove the top cover, fit a suitable 'cable stop' gland to the section of connecting cable.
- Pass the connection cable through the lower frame of the housing, to enter the box through the cable gland.
- Connect the power cable to the terminals as shown on the label on the box and tighten the cable gland.

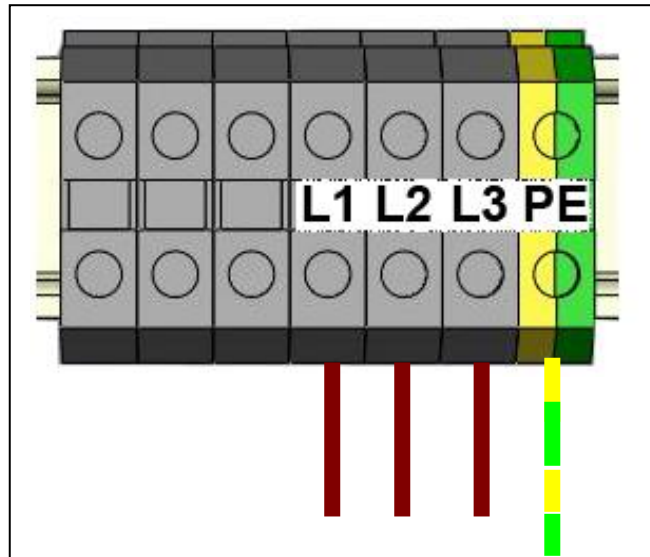

Before remounting check that the electrical insulation of the appliance is in good order (condition of the cable).

2.3. **Checks after connection**

- After connecting check:
 - That the appliance is correctly earthed (see warnings).
 - The insulation of the electrical equipment.
 - The correct operation of the appliance.

Starting up: (Refer to the user manual section on starting up the appliance for the first time).

2.4. **Table of adaptations to different supply voltages**

<i>Transformation voltage</i>	⇨				
<i>The various elect. configurations.</i>	⇩	1~230V+T	3~230V+T	3~400V+T	3~400V+N+T
E2 INDUCTION E4 INDUCTION		B	B	B	S
Wiring diagram					TR0119
A → Coupling possible B → Consult us C → Coupling impossible S-standard				D → Voltage not available	

3. APPLIANCE WIRING DIAGRAMS

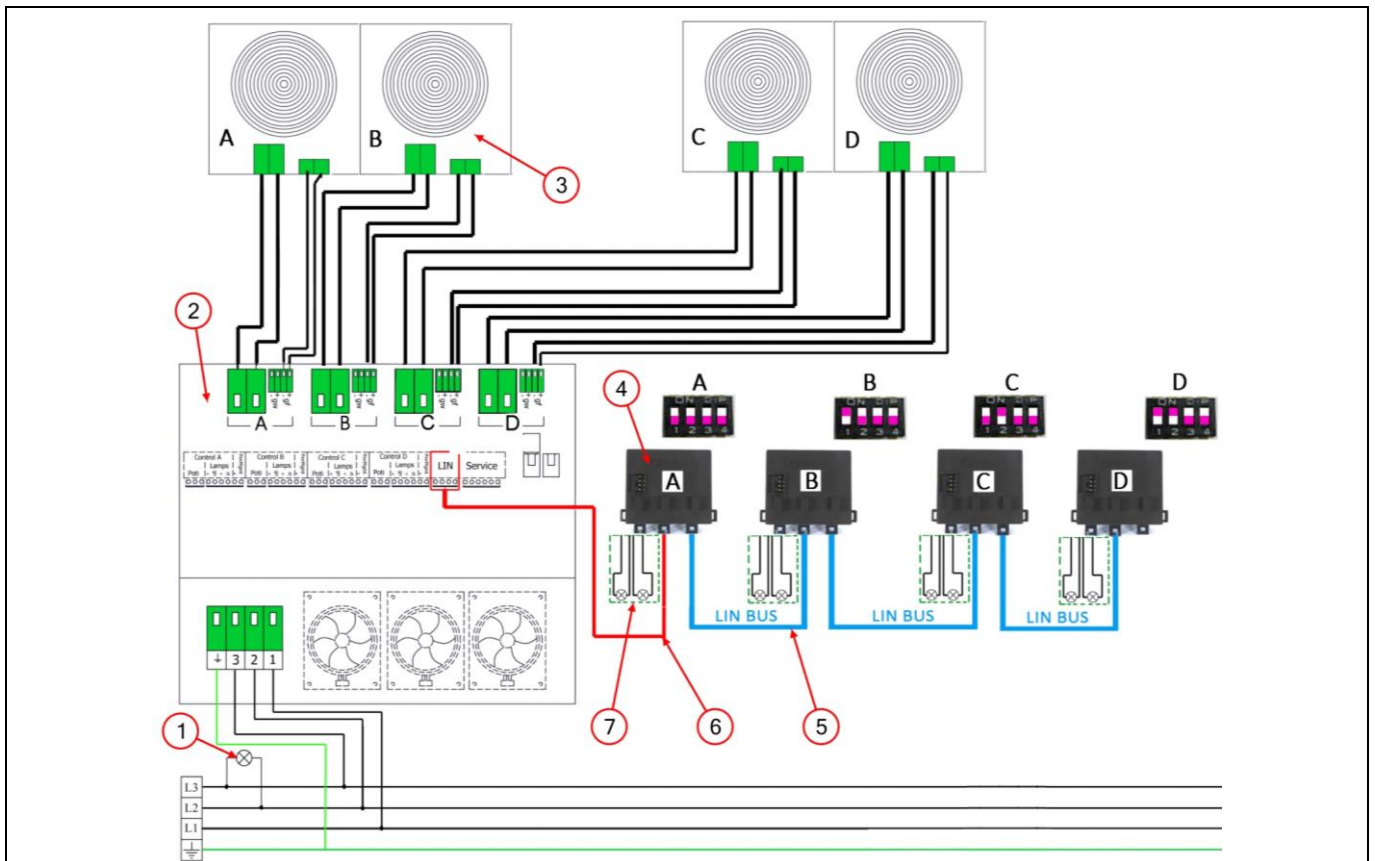

Item	Code	Description
01	173646	WHITE LIGHT 400V
02	506717	INTRO GENERATOR 2X5KW (E2IND 5000)
02	506716	INTRO GENERATOR 2X3.5KW (E2IND 3500)
03	501420	FLAT INDUCTOR
04	506617	LIN CONTROL ELEMENT FOR VARIO/INTRO INDUCTION
05	506621	CONNECTION CABLE BETWEEN LIN CONTROL ELEMENT VARIO/INTRO INDUCTION LENGTH=0.5M
	506622	CONNECTION CABLE BETWEEN LIN CONTROL ELEMENT VARIO/INTRO INDUCTION LENGTH=3M
06	506618	LIN CONTROL VARIO/INTRO INDUCTION GENERATOR LINK CABLE LENGTH=3M
	506619	LIN CONTROL VARIO/INTRO INDUCTION GENERATOR LINK CABLE LENGTH=5M
	506620	LIN CONTROL VARIO/INTRO INDUCTION GENERATOR LINK CABLE LENGTH=7M
07	506623	GREEN AND RED LIGHT FOR INDUCTION WITH LIN CONTROL ELEMENT

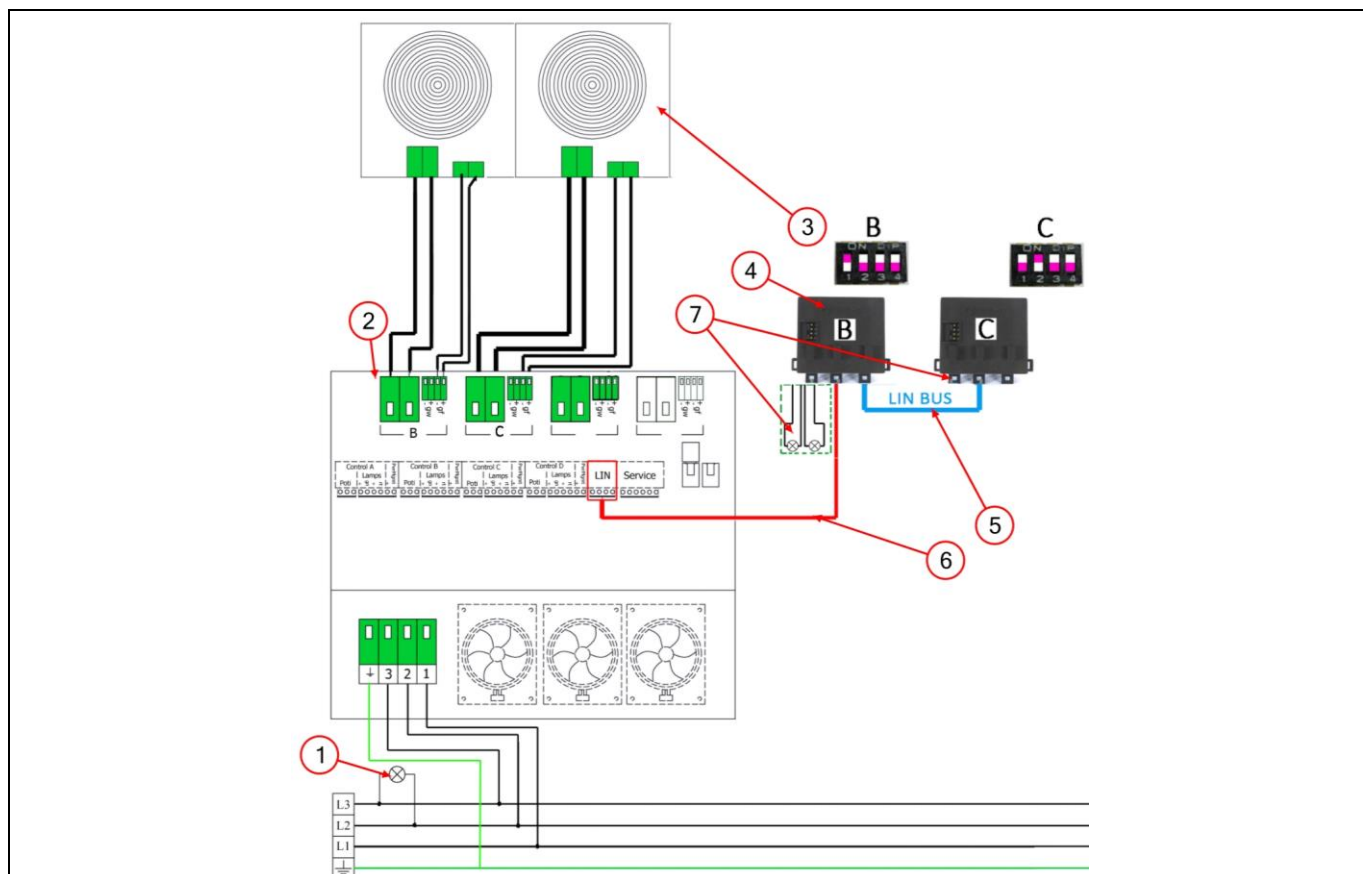

Item	Code	Description
01	173646	WHITE LIGHT 400V
02	506717	INTRO GENERATOR 2X5KW (E2IND 5000)
02	506716	INTRO GENERATOR 2X3.5KW (E2IND 3500)
03	501420	FLAT INDUCTOR
04	506617	LIN CONTROL ELEMENT FOR VARIO/INTRO INDUCTION
05	506621	CONNECTION CABLE BETWEEN LIN CONTROL ELEMENT VARIO/INTRO INDUCTION LENGTH=0.5M
	506622	CONNECTION CABLE BETWEEN LIN CONTROL ELEMENT VARIO/INTRO INDUCTION LENGTH=3M
06	506618	LIN CONTROL VARIO/INTRO INDUCTION GENERATOR CONNECTION CABLE LENGTH=3M
	506619	LIN CONTROL VARIO/INTRO INDUCTION GENERATOR LINK CABLE LENGTH=5M
	506620	LIN CONTROL VARIO/INTRO INDUCTION GENERATOR CONNECTION CABLE LENGTH=7M
07	506623	GREEN AND RED LIGHT FOR INDUCTION WITH LIN CONTROL ELEMENT

Induction generator

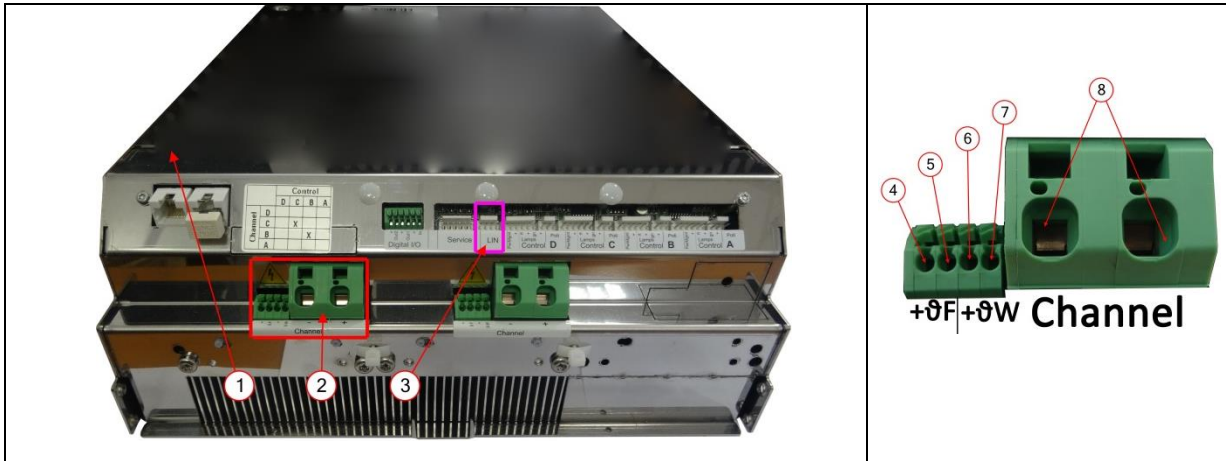

Figure A

Figure B

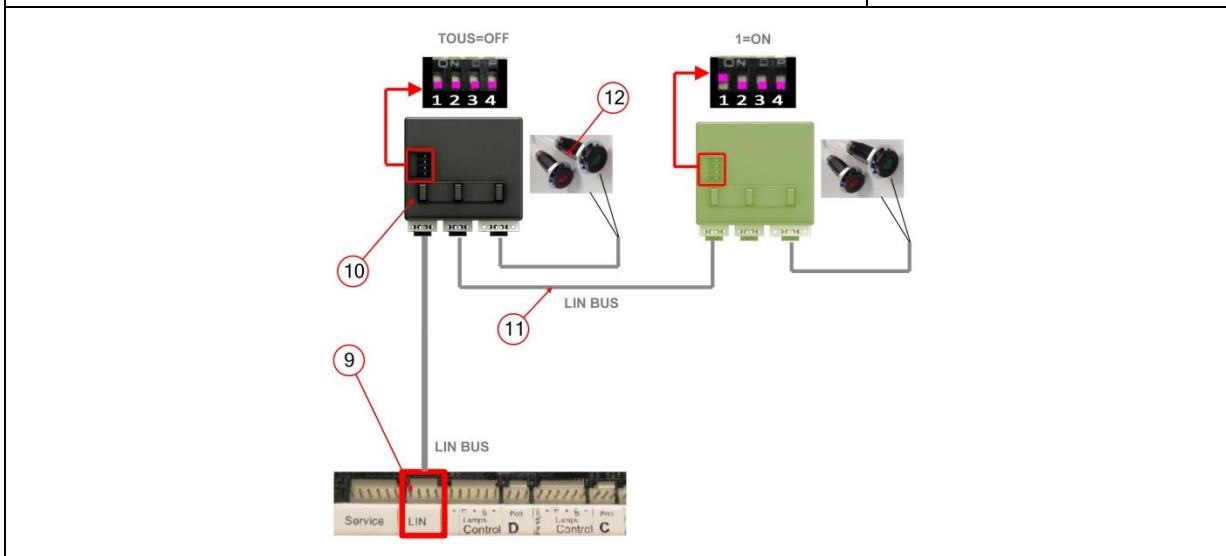
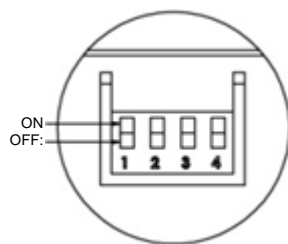

Figure C



DIP SWITCH			
1	2	3	4
Hob ID		Dual control	Clockwise/counter clockwise mode
0... 3		0 = Off 1 = On	0 = Clockwise 1 = Anticlockwise

Detail switches 1 and 2			
1	2	Hob No.	Control
OFF	OFF	0	A
ON	OFF	1	B
OFF	ON	2	C
ON	ON	3	D

CAUTION MAX. LENGTH OF CABLE ITEMS 2 + 3 = 10 METRES

Figure D

Item	Description
1	Induction generator
2	Inductor connection and temperature probe
3	Control element
4&5	Flat safety probe connection. (+9F) (-9F)
6&7	Connection of options (+Pu)
8	Inductor coil (power) connected to the inductor

9	LIN connection (Generator)
10	LIN control element
11	Connection cable between LIN control element induction
12	Green and red light connection

3.2. **Maintenance:**

Before carrying out any maintenance on the appliance, cut off the electrical supply. Disconnect the electrical supply of the appliance at the terminal block.



Figure E

Remove control cover:

Unscrew the cover's retaining screws (Figure A Item 1) pull the control cover towards you.

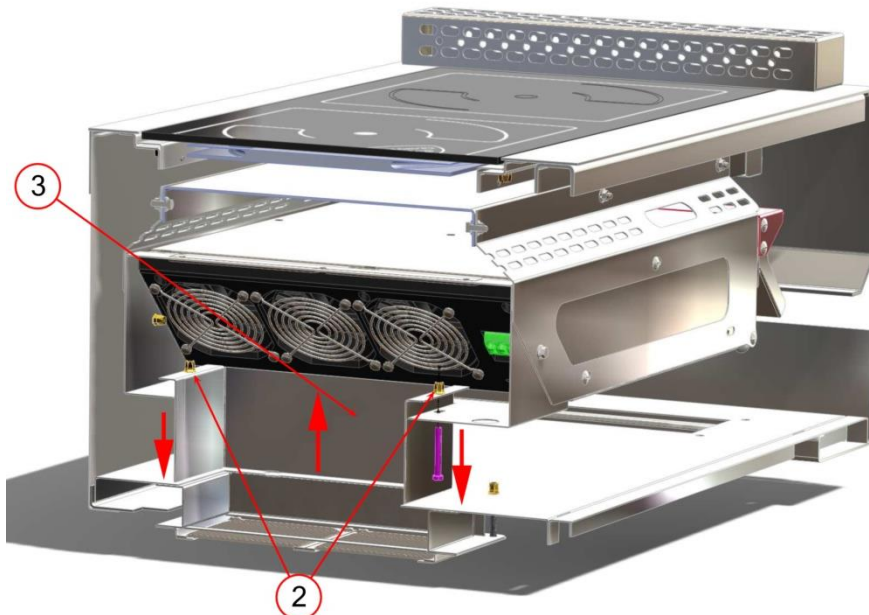

Figure F

Unscrew the suction half pipe's retaining screws (Figure B Item 2). Pull it upwards (Figure B Item 3).

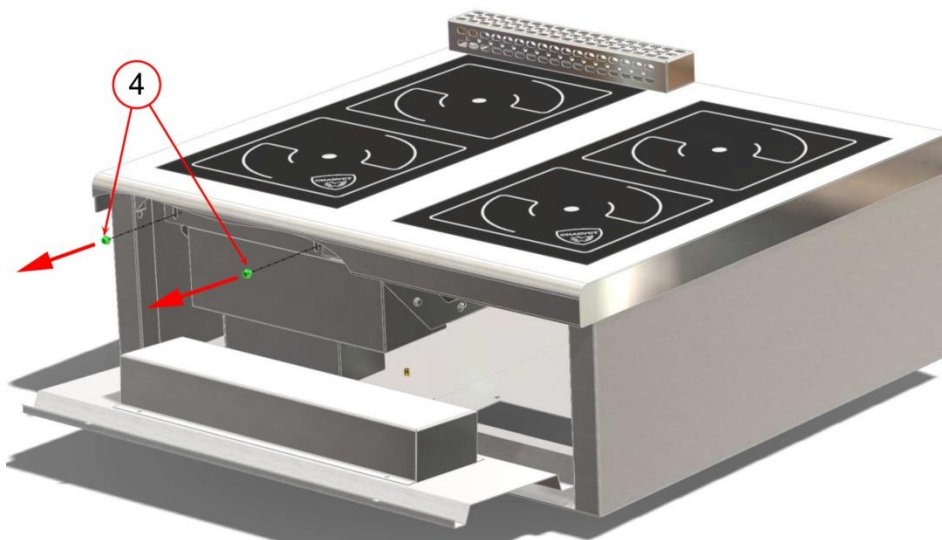

Figure G

Caution: the induction kit is heavy. Use a steadying device.

Unscrew the inductor's retaining screws (Figure C Item 4).
Then pull the induction kit towards you (Figure D Item 5)

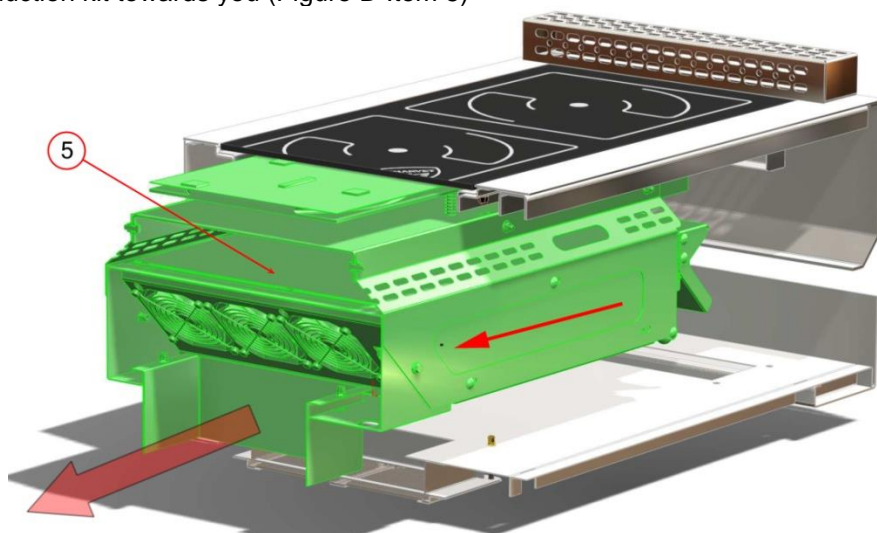
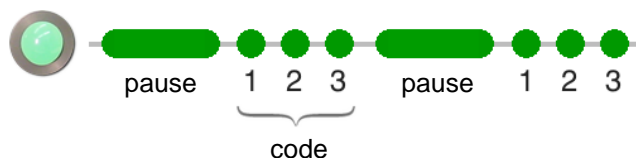

Figure H

4. LIST OF EMERGENCY PARTS.

Code	Description	Price	Code	Description	Price	Code	Description	Price
501420			505100			506617		
Flat inductor 2x5Kw			Glass ceramic plate 325x650			LIN control element		
506985 507123			500664			506623		
Generator 4x5KW / 2x5KW			Glass ceramic plate 650x650			Green and red induction light		
501146			507001			169286		
Chrome plated electric control knob			Induction probe			Suction support grid		
173646			F07816			07250 A		
White light 400V			Induction flue			Ventilator screen		

■ Error message (code)



5. PROBLEMS

Problems detected by the generator are highlighted by the illumination of the red and green lights. The green light defines the type of fault according to a predetermined cycle: a long steady light + a code (number of flashes between steady light periods).

Code*	Error	Cause	Action
1	Overcurrent on hardware	Inadequate pan material or defective inductor	Use a suitable pan or check the inductor
2	No inductor current	Inductor not connected No current to the inductor	Connect the inductor
3	Radiator temperature too high	Blocked ventilation ducts Dirty ventilator. Faulty temperature probe	Clear the ventilation ducts. Clean the ventilator, and change the probe
4	Cooking zone temperature too high or too low	Empty pan	Remove the pan and switch off the power supply, then wait for the cooking zone to cool down. Change the temperature probe.
5	Open circuit at control	Faulty control	Check/replace the control knob.
6	Interior temperature too high or too low	Blocked ventilation ducts. Dirty ventilator. Faulty temperature probe.	Clear the ventilation ducts. Clean the ventilator/change the probe.
7	Cooking zone temperature probe	Short circuit of the probe measuring the temperature of the inductor.	Check/replace the control probe.
8	Phases error	Faulty phase	Check the phases
10	Communication error	LIN-Bus or CAN-Bus No connection between the keyboard and generator	Disconnect the main power supply and check the connection
11	Reset error	Error during hardware reset.	Wait for the automatic update approximately every 30 seconds.
12	Error at power supply	Current measurement error	Check the connection to the electricity supply
13	Electricity supply connection error	Error due to too high or too low voltage	Check the connection to the electricity supply
14	Power supply error	Error due to too high or too low power supply voltage	Check the connection to the electricity supply
15	Protection Auto safety shut off	Empty pan or defective probe	Remove the pan. Turn off the hob and wait until the cooking zone has cooled down, replace the probe if necessary. Disconnect the appliance and reconnect it after a few minutes.

*Code: Number of flashes (1xlong+code)

The red light and the green light are both on all the time:

Error	Cause	Action
The cooking zone does not heats up enough	The pan material is unsuitable A mains phase is missing	Use a suitable pan Check the connection to the power supply
The cooking zone constantly heats up to maximum power	Faulty switch	Check the switch
The empty cooking zone comes on	Defective pan detection system	Replace the generator/have it repaired
Small metal objects are heated	Defective container detection system	Replace the generator/have it repaired

The green light comes on briefly:

Error	Cause	Action
The cooking zone does not heat up	Diameter of the pan base is less than 12 cm A mains phase is missing	Use a suitable pan Check the connection to the power supply

The lights are off:

Error	Cause	Action
The appliance does not respond	Faulty mains fuse/electric cable	Check the connection to the power supply
Fuses blow when switched on	Short circuit in the generator	Replace the generator/have it replaced
Some cooking zones do not heat up	Faulty generator	Replace the generator/have it replaced

DESCRIPTION	MODULAR	
	800	900
B-E4IND 5000	V03605	V03607
R-E4IND 5000	V03604	V03606
1/2R-E2IND 5000	V03598	V03600
1/2B-E2IND 5000	V03599	V03601



User manual

CONTENTS

USER MANUAL	14
1. INTRODUCTION:	17
2. STARTING UP FOR THE FIRST TIME	18
2.1. CONTROL PANEL:	18
3. STARTING UP	19
3.1. INDUCTION:	19
3.1. ERROR INDICATOR LIGHT	20
3.2. INDUCTION PLATE 5000	20
4. TURNING THE APPLIANCE OFF	21
5. CLEANING	21
5.1. CLEANING THE STAINLESS STEEL SURFACES:	21
5.2. CLEANING THE GLASS CERAMIC PLATE	21
5.3. CLEANING THE AIR FILTER	22
6. PROBLEMS	22

'Compliance with French Decree No. 2005-829 of 20 July 2005'

Exclusively for France

A - In accordance with Article 18 of Decree No. 2005-829 of 20 July 2005 on the disposal of waste electrical and electronic equipment, the Paul CHARVET company takes responsibility for the financing and organisation of the disposal of its waste. As such, the Paul CHARVET company resumes full ownership of the electrical and electronic equipment at the end of its life. The equipment should be palletised and ready for loading in a place that is accessible by the carrier. Except in exceptional circumstances, the equipment shall in no case have been dismantled, even partially, otherwise CHARVET reserves the right to re-invoice the costs of processing and taking responsibility for the equipment.

B- How WEEE is disposed of:

The terms and conditions of disposal are covered by the SYNEG/RECYSTEM-PRO agreement, which states that: "In order to fulfil their obligations, the producers of electrical and electronic equipment for large kitchens grouped within the SYNEG, have implemented arrangements for the collection and processing/recycling of WEEE in accordance with the provisions of the decree.

Materials or substances harmful to the environment (such as refrigerants or foams) are extracted or separated. The metal fractions (stainless steel, zinc, copper, etc.) are crushed and transported to refiners for reuse.

Therefore, when you need to have electrical equipment collected by a SYNEG professional kitchen equipment manufacturer, you must contact RECYS'TEM-PRO, the operator chosen for the management of WEEE

↳ at this telephone number: 01 45 01 71 43.

↳ or at the following e-mail address: synegdeee@recystempro.com

You will then be sent a collection request sheet which will contain the following elements:

- name of the producer of the equipment
- type of equipment
- estimated weight
- place of collection
- name and contact details of the installer
- invoicing address

After verification with the producer and obtaining its agreement, RECYS'TEM-PRO will proceed with the collection."

"This device complies with the 2009/142 (Declaration of conformity to type) directive"



1. INTRODUCTION:

- A) Our appliances are intended for professional use and should be used by qualified personnel.
- B) They must be installed in accordance with the regulations and standards in force in the country of installation, in a sufficiently ventilated room with an extractor hood.
- C) The appliance may be attached to others or placed against fire-proof walls, but must not, under any circumstances, be located within 10 cm of any combustible element.
- D) Any modifications to existing equipment or any new installations must be carried out by a qualified installer.
- E) WARRANTY: *The warranty is part of the sale contract. For any work to be carried out under the warranty, please contact an authorised dealer. This warranty does not cover any damages due to faulty installation, misuse or inadequate maintenance.*

Warning:

STAFF, COLLABORATORS AND VISITORS MUST BE ADVISED OF THE POSSIBLE RISKS TO PERSONS WITH PACEMAKERS OR METALLIC IMPLANTS. THESE PERSONS SHOULD CONSULT A DOCTOR OR THE MANUFACTURER OF THE MEDICAL EQUIPMENT.

PERSONS WITH A PACEMAKER SHOULD NOT USE THIS TYPE OF APPLIANCE.

DO NOT HEAT UP AN EMPTY PAN AS THIS WILL CAUSE THE GENERATOR TO AUTOMATICALLY SHUT OFF (RED LIGHT COMES ON).

Warning:

IF THE SURFACE IS CRACKED, IMMEDIATELY DISCONNECT THE APPLIANCE OR THE APPROPRIATE PART OF THE POWER SUPPLY.

CAUTION: ALUMINIUM FOIL AND PLASTIC CONTAINERS SHOULD NOT BE PLACED ON THE HOT SURFACES. GLASS CERAMIC SURFACES SHOULD NOT BE USED FOR STORAGE OF ANY KIND.

2. STARTING UP FOR THE FIRST TIME



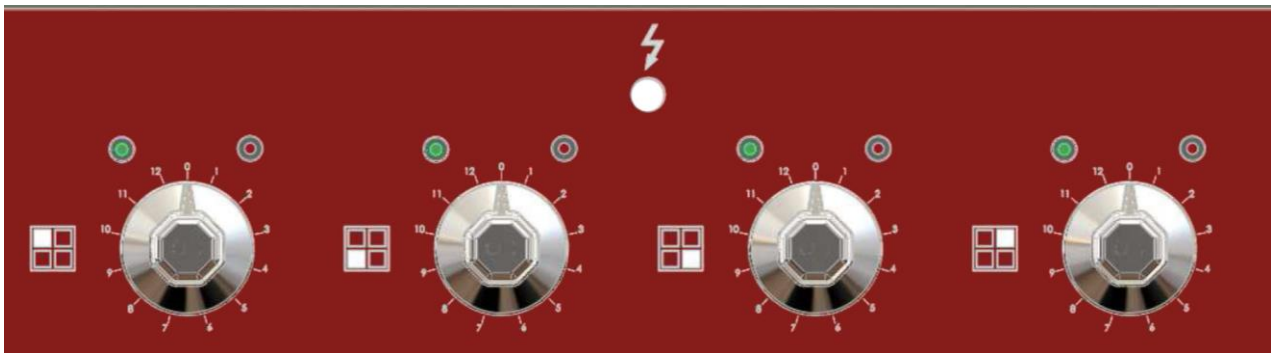
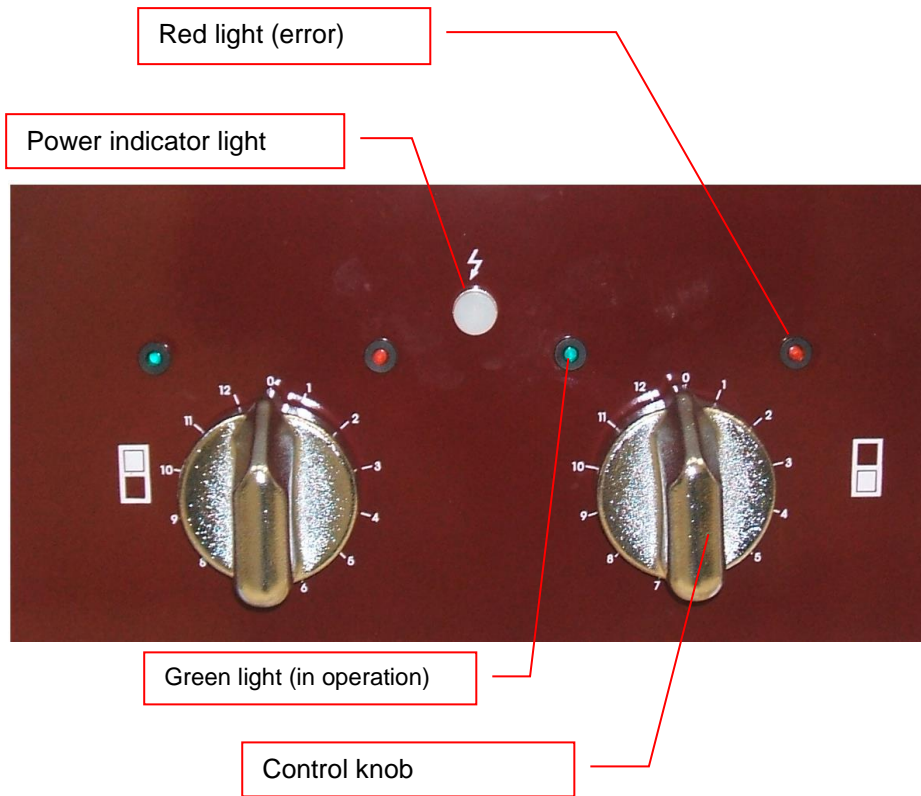

- a) Remove all protective plastic wrapping from the stainless steel parts.
- b) Prior to starting up, it is advisable to clean the appliance in order to eliminate all dust or impurities that have accumulated during storage.
- c) Ensure that all the control elements are in good working order.
- d) Turn on the appliance.

2.1. **Control panel:**



3. STARTING UP

3.1. Induction:

<u>Functional testing:</u>	The generator must be fully connected. Fill pans with water. → See also "Handling".
Do the following for each inductor:	
<u>Control indicators</u>	If there is no pan on the hob, the service indicator light should emit short flashes (green indicator light) 
Only for the control knob	The error light should only come on in the event of a malfunction (red light) 
<u>Ventilator:</u>	<ol style="list-style-type: none"> 1) Place a pan on each of the inductors 2) Set all of the inductors to maximum power 3) The ventilator should come on after a few minutes.
Do the following for each inductor:	The pan heats up + displays appear
<u>Detection of pans</u>	 1) Place the pan (at least Ø12cm) (green light)
The inductors should not come on if there is no pan on them!	 2) Remove the 'short flash' pan
Handling:	Do not heat empty pans without keeping an eye on them. Always centre the pan on the inductor.

Handling:

Control knob:

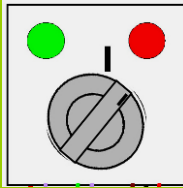
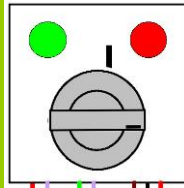
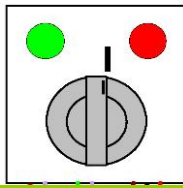

Inductor on (green light)
 Inductor on, no pan (green light)
 Error (green light) 1x long + code
 Error (red light)

ON	+/-	OFF
Turn the knob to the desired position	Turn the knob to the desired position	Move the knob to the Off position.
		

3.1. **Error indicator light**

A possible fault is displayed by means of the control indicator light for each of the cooking zones. In the event of a fault, the zone concerned no longer supplies power, the green light goes out and the red light comes on (see chapter on error messages).

PRACTICAL ADVICE

The induction stove makes all kinds of cooking possible.

This appliance is only suitable for flat-based cookware specific to induction heating.

When the cooking temperature is changed, pans are quickly subjected to the new temperature. Empty pans heat up very quickly, ready for roasting.

When heating oil or grease, watch the pan at all times to prevent the grease or oil from overheating or burning.

Maximum efficiency is achieved with cookware that is suitable for induction, and of good quality.

- ☞ The detection diameter is 12 cm.
- ☞ Do not leave small metal objects near the cooking zone as they may heat up.
- ☞ Do not wear jewellery or a watch when using the appliance.
- ☞ Do not place aluminium foil on the cooking zone as it may melt and damage the glass ceramic.
- ☞ If the pan is removed from the cooking zone for a while, turn off the power.

Multiple pans

It is possible to place several pans on the same cooking zone under certain conditions:

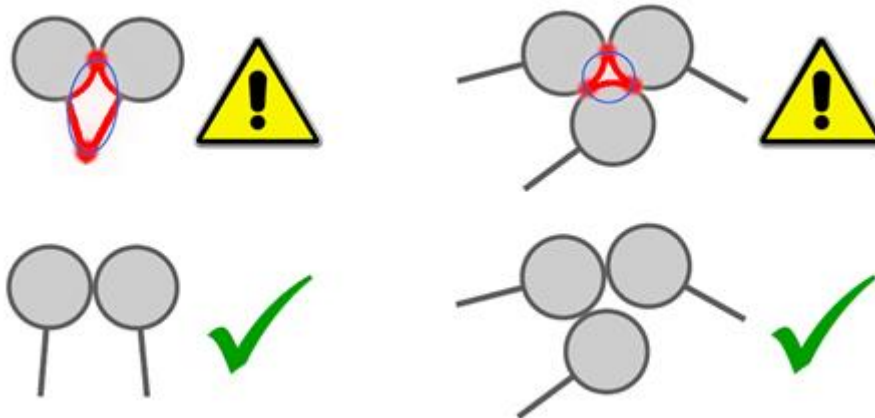

Note: Position the pans so that they do not touch one another (risk of welding to each other).

3.2. **Induction plate 5000**

- a) Move the knob to the desired position.
The green light emits short flashes: the inductor comes on.
- b) Place a pan on the ceramic glass plate. The green light is on, the pan is heating up.

4. TURNING THE APPLIANCE OFF

Return the control knob to position,  = Off
 At the end of the day, shut off the electric power supply.

5. CLEANING

Wait until the elements near the plate have cooled down.

5.1. **Cleaning the stainless steel surfaces:**

a) Switch off the appliance. After each service and before each cleaning operation we strongly advise you to disconnect the appliance from the mains.

b) Wash with a sponge in soapy water (or any other neutral cleaning product).

Do not use bleach or any acid if heavily diluted..

If necessary, use a scouring sponge to clean the tops, taking care to always rub ***in the direction of polishing.***

After each cleaning, rub with an oily rag.

This appliance must not be cleaned by means of water spray or water jets under pressure. Check that the appliance is disconnected at the mains.

Plate cleaning, glass ceramic



5.2. **Cleaning the glass ceramic plate**

Before doing anything, wait for the plate to cool down in order to avoid any risk of burns. The ceramic glass plate should be cleaned regularly while warm or cold.

Light spillages/stains:

Light, loose spillages and stains can be removed with moist kitchen paper.

Tough stains:

Resistant, burnt-on stains can be removed simply using a cleaning product that does not cause a hot chemical reaction with the glass ceramic.

(Use only commercially available products specifically made for glass ceramic hobs.)

Unsuitable products:

Never use abrasive or corrosive detergents, such as aerosol sprays for grills and ovens, stain removers, scouring powders and sponges with an abrasive surface.

When cleaning, visually check the quality of the seal between the top and the glass ceramic plate. If the seal presents cracks or discontinuity, the appliance must be immediately turned off, isolated from the electrical power supply and locked out/tagged out. Notify your installer.

5.3. **Cleaning the air filter**

The air filter should be cleaned once a week to ensure the proper cooling of the generator.

Cleaning the induction air filter

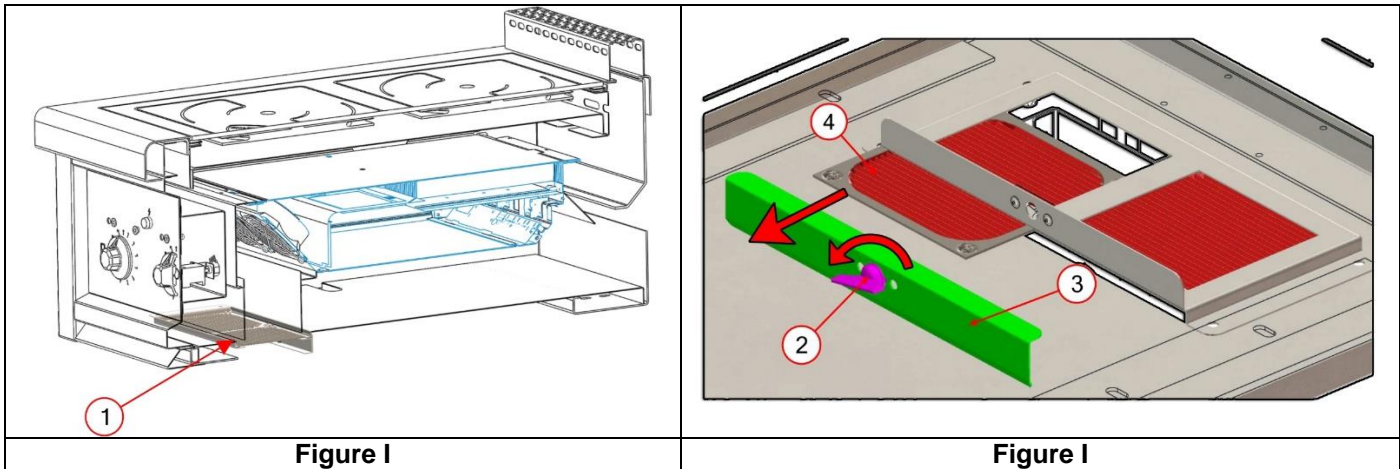

Cleaning the filter.

- The air filter (Figure H Item 1) should be cleaned once a week to ensure the proper cooling of the generator.
- Release the lock (Figure I Item 2) and remove the end from the support (Item 3).
- Remove the filters. (Figure I Item 4).
- Soak them in warm soapy water. Clean the filters with water.

DO NOT SWITCH ON THE APPLIANCE WITHOUT THE FILTER.

Caution:

When installed near open burners, take the necessary precautions when cooking with fats to avoid starting a fire.

Do not obstruct the space between the door and the floor of the cabinet when using the appliance (risk of malfunction).

The top and walls of the appliance may be very hot after intense or prolonged use.

For best results, have your equipment serviced and cleaned regularly, according to the intensity of its use, by a qualified installer.

Caution: Caution: Some parts of this appliance are factory-sealed by the manufacturer. In case of a fault, call a qualified installer.

6. PROBLEMS

Contact the installer to replace any faulty electric control components before further use.

Error message (code)

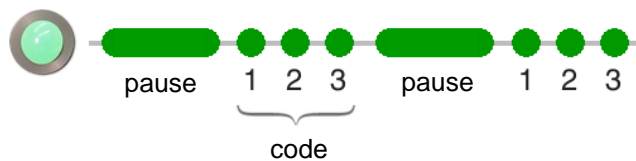

Problems detected by the generator are highlighted by the illumination of the red and green lights. The green light defines the type of fault according to a predetermined cycle: a long steady light + a code (number of flashes between steady light periods).

*Code: Number of flashes (1xlong+code)

The red light and the green light are both on all the time:

Error	Cause	Action
The cooking zone does not heats up enough	The pan material is unsuitable A mains phase is missing	Use a suitable pan Check the connection to the power supply
<u>The cooking zone constantly heats up to maximum power</u>	<u>Faulty switch</u>	<u>Check the switch</u>
<u>The empty cooking zone comes on</u>	<u>Defective pan detection system</u>	<u>Replace the generator/have it repaired</u>
<u>Small metal objects are heated</u>	<u>Defective pan detection system</u>	<u>Replace the generator/have it repaired</u>

Code*	Error	Cause	Action
1	Overcurrent on hardware	Inadequate pan material or defective inductor	Use a suitable pan or check the inductor
3	Radiator temperature too high	Blocked ventilation ducts Dirty ventilator. Faulty temperature probe	Clear the ventilation ducts. Clean the ventilator, and change the probe
4	Cooking zone temperature too high or too low	Empty pan	Remove the pan and switch off the power supply, then wait for the cooking zone to cool down. Change the temperature probe.
5			
6	Interior temperature too high or too low	Blocked ventilation ducts. Dirty ventilator. Faulty temperature probe.	Clear the ventilation ducts. Clean the ventilator/change the probe.
7			
8			
10			
11	Reset error	Error during hardware reset.	Wait for the automatic update approximately every 30 seconds.
12			
13			
14			
15	Protection Auto safety shut off	Empty pan or defective probe	Remove the container. Turn off the hob and wait until the cooking zone has cooled down, replace the probe if necessary. Disconnect the appliance and reconnect it after a few minutes.



The green light comes on briefly:

Error	Cause	Action
The cooking zone does not heat up	Diameter of the pan base is less than 12 cm A mains phase is missing	Use a suitable pan Check the connection to the power supply

The lights are off:

Error	Cause	Action
<u>The appliance does not respond</u>	<u>Faulty mains fuse/electric cable</u>	<u>Check the connection to the power supply</u>
<u>Fuses blow when switched on</u>	<u>Short circuit in the generator</u>	<u>Replace the generator/have it replaced</u>
<u>Some cooking zones do not heat up</u>	<u>Faulty generator</u>	<u>Replace the generator/have it replaced</u>

PRO 800-900 E INDUCTION 5000

Code	Description	Price	Code	Description	Price	Code	Description	Price
501420			505100			50661 7		
Flat inductor 2x5Kw			Glass ceramic plate 325x650			LIN control element		
506985 507123			500664			50662 3		
Generator 4x5KW / 2x5KW			Glass ceramic plate 650x650			Green and red induction light		
501146			507001			16928 6		
Chrome plated electric control knob			Induction probe			Suction support grid		
173646			F07816			07250 A		
White light 400V			Induction flue			Ventilator screen		