



PRO800-900

AUTHENTIC COOKING EQUIPMENT

# STEEL & CHROME ELECTRIC PLANCHA

## INSTALLATION MANUAL

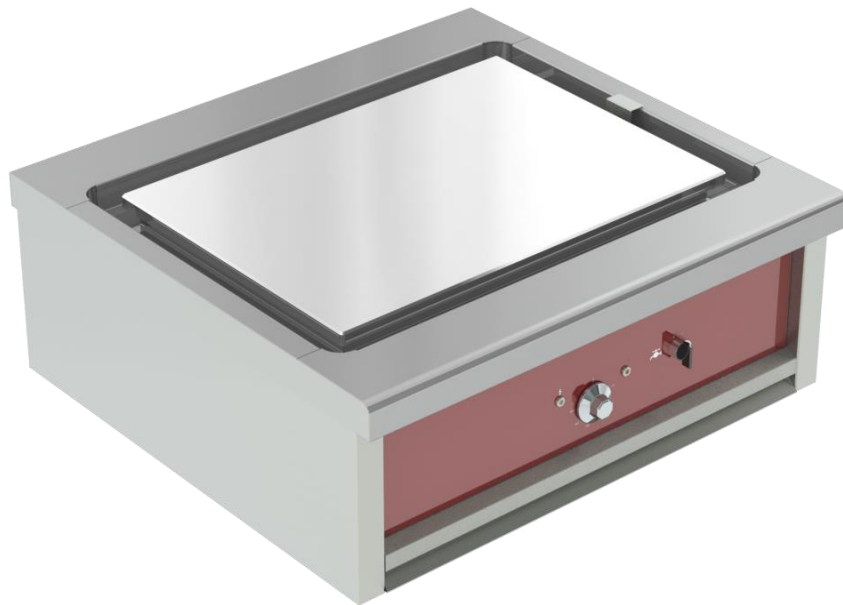

### INSTALLATION MANUAL

FR\_PRO800-900\_PRO800-900 E-1 PLANCHA  
ACIER ELECTRIQUE PRO800-900 E-1 PLANCHA  
CHROME ELECTRIQUE-REV. A  
Written by JGD on 08/07/20  
Revised by JGD on 21/07/20

### APPLICABLE TO:

V03502	V03506	V03504	V03500	V03513
V03514	V03503	V03505		



# CONTENTS

---

<b>INTRODUCTION</b>	<b>1</b>
1. FOREWORD	1
2. USEFUL CONTACT DETAILS	1
3. WARRANTY	1
4. RESTRICTIONS ON USE	1
5. EQUIPMENT DISPOSAL	1
<b>INSTALLATION</b>	<b>2</b>
1. GENERAL POINTS	2
2. HANDLING	2
3. INSTALLATION	2
4. ASSEMBLY AND SPECIAL PRECAUTIONS	2
5. DATA PLATE	2
<b>ELECTRICAL CONNECTION</b>	<b>3</b>
1. BEFORE ELECTRICAL CONNECTION	3
2. ELECTRICAL CONNECTION	3
3. AFTER CONNECTION	3
<b>WATER CONNECTION</b>	<b>4</b>
1. BEFORE CONNECTION	4
2. CONNECTION	4
3. CHECKS AFTER CONNECTION	4
<b>STARTING UP</b>	<b>5</b>
1. GENERAL POINTS	5
2. PLANCHA CONTROL PANEL	5
3. NORMAL USE OF THE PLANCHA	5
4. SWITCHING OFF	5
<b>ADJUSTMENTS – MAINTENANCE</b>	<b>6</b>
1. PERIODIC CHECKS	6
2. CONTROL PANEL REMOVAL	6
<b>ELECTRIC &amp; WATER DIAGRAMS</b>	<b>7</b>
3. WIRING DIAGRAM PLANCHA 300X500	7
4. WIRING DIAGRAM PLANCHA 700X500	8
5. WATER SUPPLY DIAGRAM	9
<b>EXPLODED VIEW</b>	<b>10</b>
<b>SPARE PARTS</b>	<b>12</b>



# REVISION HISTORY

---

Revision index	Author of the revision	Date of the revision	Nature of the revision
B	JGD	09/07/2020	Update and addition of run-off as standard



# INTRODUCTION

## 1. FOREWORD

Thank you for choosing Charvet equipment for your installation. Our equipment is designed and manufactured in France by our teams, who are committed to meeting five targets: Robustness, performance, hygiene, ergonomics, and safety.

If, however, despite our commitment and effort, you encounter a problem with one of our products, please get in touch with our After-sales service.

## 2. USEFUL CONTACT DETAILS

For any information, or sales request:

✉ [info@charvet.fr](mailto:info@charvet.fr)

☎ +33 (0)4 76 06 64 22

For all technical assistance requests, contact our After-sales service department:

✉ [sav@charvet-sa.fr](mailto:sav@charvet-sa.fr)

☎ +33 (0)4 76 06 68 14

## 3. WARRANTY



INFORMATION

The warranty is part of the sale contract. For any installation or work carried out under the warranty, contact an authorised dealer. In addition, we would like to remind you that the CHARVET warranty does not cover damage caused by faulty installation, misuse or inadequate maintenance. Please read this manual in full.

## 4. RESTRICTIONS ON USE



INFORMATION

This appliance should only be used by qualified persons. The installer should provide training on how to use the appliance once it has been installed. After the user training, the User Manual (below) must be passed to the final user for their records.

CHARVET equipment should not be used by untrained personnel unless they are under the supervision of a person who is liable and can guarantee their safety.

## 5. EQUIPMENT DISPOSAL



INFORMATION

### Exclusively for France:

In accordance with Decree No. 2014-928 of 19 August 2014, concerning the disposal of waste and electrical and electronic equipment, the Paul CHARVET company is responsible for the organisation and financing of the collection and processing of professional EEE placed on the market from 13.08.2005. As such, the CHARVET company is a member of ECOLOGIC, an eco-organisation approved by the state.

### How WEEE is disposed of:

At the end of its life, the equipment must be palletised and made available to the carrier in an accessible place. Except in exceptional circumstances, the equipment shall not have been dismantled, even partially. Otherwise, the CHARVET company reserves the right to re-invoice the costs of processing and taking responsibility for the equipment.

In addition, all requests weighing less than 500 Kg shall either be dropped off by the end user at a collection point or collected from the end user's premises, in which case the end user will be liable to pay the cost of such collection.

### For any request for collection:

[www.e-dechet.com](http://www.e-dechet.com)

+33 (0)1 30 57 79 14



# INSTALLATION

## 1. GENERAL POINTS

The installation must be performed by a certified installer, who will install the equipment according to best practice, and in compliance with the instructions in this manual and local regulations.

During installation, special attention should be paid to the fire prevention regulations of the establishment concerned.

## 2. HANDLING

For all handling, leave the appliance on its wooden pallet during the handling process until the final installation.

Unpack and check the appliance for damage upon receipt.



WARNING

### In the event of damage:

In case of damage, detail it immediately on the delivery note; notify the carrier by registered mail with acknowledgement of receipt within 48 hours.

## 3. INSTALLATION

The appliance must be placed under a functioning extraction hood. If the appliance is to be installed against a wall or partition, near a piece of furniture or decorative borders, it is recommended that these are made of fireproof material.

If this is not the case, they must be protected by an approved fireproof, insulating material. If there is any doubt about the nature of the materials in the vicinity of the appliance, place it at a minimum distance of 20 centimetres from the wall.

## 4. ASSEMBLY AND SPECIAL PRECAUTIONS

It is mandatory that the appliance be levelled before any use. To set the level it is possible to adjust each leg (or bolt if using a concrete plinth) individually.

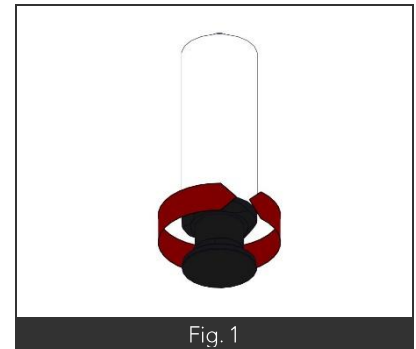

Fig. 1

## 5. DATA PLATE

Each appliance has a data plate. Its location varies according to the configuration of the appliance:

- **The appliance is mounted in open cabinet or closed cabinet configuration:**  
The data plate is underneath the removable bottom of the cabinet.
- **The appliance is mounted in warmer configuration:** As a priority, the data plate is installed on the front of the appliance. It is also possible for it to be on the burner support or the protective casing of the appliance's control panel.
- **The appliance is mounted in (electric or gas) oven configuration:**  
The data plate is on the front of the appliance.

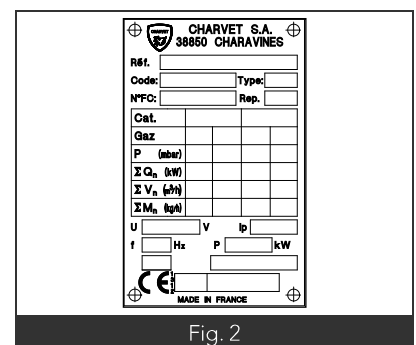

Fig. 2

# ELECTRICAL CONNECTION



WARNING

## Instructions for the electrical connection of the appliance:

- Do not work on live cables.
- The appliance must be earthed.
- Use 245 IEC 57 or 245 IEC 66 standard cables (or other cables with similar characteristics).
- Ensure that the user's fixed installation has an all-pole circuit breaker with point gap in compliance with standard EN 60335 – 1.
- If the cable is damaged, a qualified person must be called in to replace it.

## In the case of a mobile appliance connected to the network via an electric socket:

- The size of the electric plug depends on the power of the appliance. If necessary, replace it with a socket with the same characteristics.
- During use, the electric socket must remain accessible at all times.

## 1. BEFORE ELECTRICAL CONNECTION

Before making the electrical connection of the appliance, you must:

- Locate the position of the electrical junction box and the equipotential bonding terminal.
- Check that the appliance's power supply is switched off while connecting the appliance.
- Ensure that the electrical voltage of the supply is compatible with the voltage and power required by the appliance.

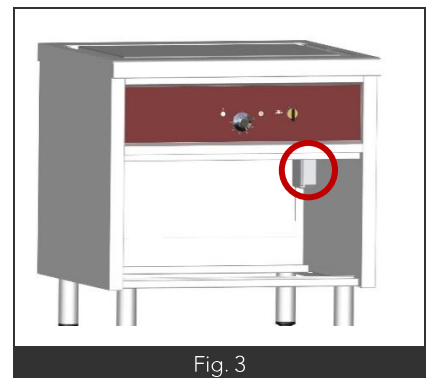

Fig. 3

## 2. ELECTRICAL CONNECTION

Connect the installation's fixed electrical supply to the appliance's electrical circuit via the junction box.

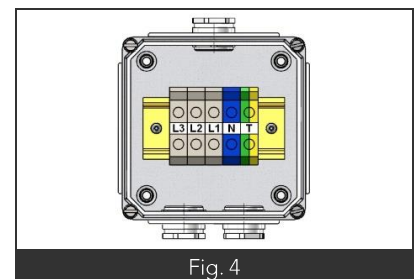

Fig. 4

### Equipotential bonding:

The appliance must be included in an equipotential system, the operation of which must be verified in accordance with the regulations in force in the country of installation. Connect the equipotential terminal, the location of which is marked by the standard symbol IEC60417-502 2002-10 (shown in illustration).

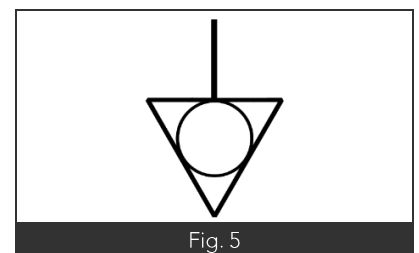

Fig. 5

## 3. AFTER CONNECTION

After connecting the appliance, ensure that the cable connections to the terminal block are sufficiently tight, and that the system is properly earthed.

# WATER CONNECTION

If the appliance is fitted with a drain or a mixed water tap, the connection must be made at the connection point(s) on the appliance intended for this purpose. These are to be found at the location indicated on the plumbing drawing.  
The same is true for the water drains.

## 1. BEFORE CONNECTION

- Drain the pipes and clean the filter.
- Check that the siphon and the drain pipes are not blocked.

## 2. CONNECTION

- Your water hose should be connected to the connector located underneath the plancha or inside the plancha's closed cabinet if fitted (Fig. 6).

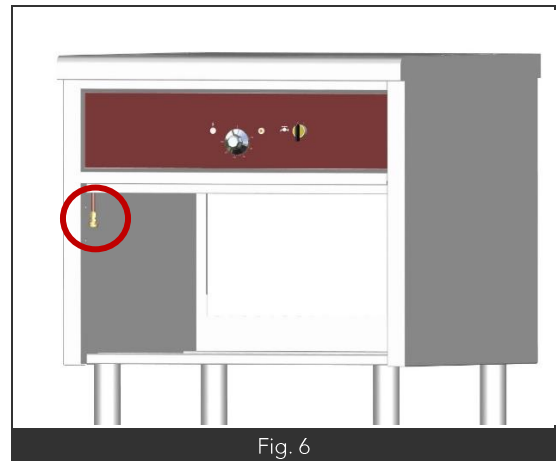

## 3. CHECKS AFTER CONNECTION

- The watertightness of the water circuit.
- The correct operation of the water circuit (water inlet and drain).
- Check the solenoid valve.



# STARTING UP

## 1. GENERAL POINTS

Once the appliance has been installed, remove all protective plastic wrapping, then test each function of the appliance; please refer to the paragraph on 'Normal use' in this user manual.

If the test is successful, the appliance should be fully cleaned, in accordance with the instructions given in the paragraph on 'Cleaning' in the user manual, before delivery from the site to the end customer.

When delivering from the site to the user, the user or person in charge should be given the user manual for each appliance.

## 2. PLANCHA CONTROL PANEL

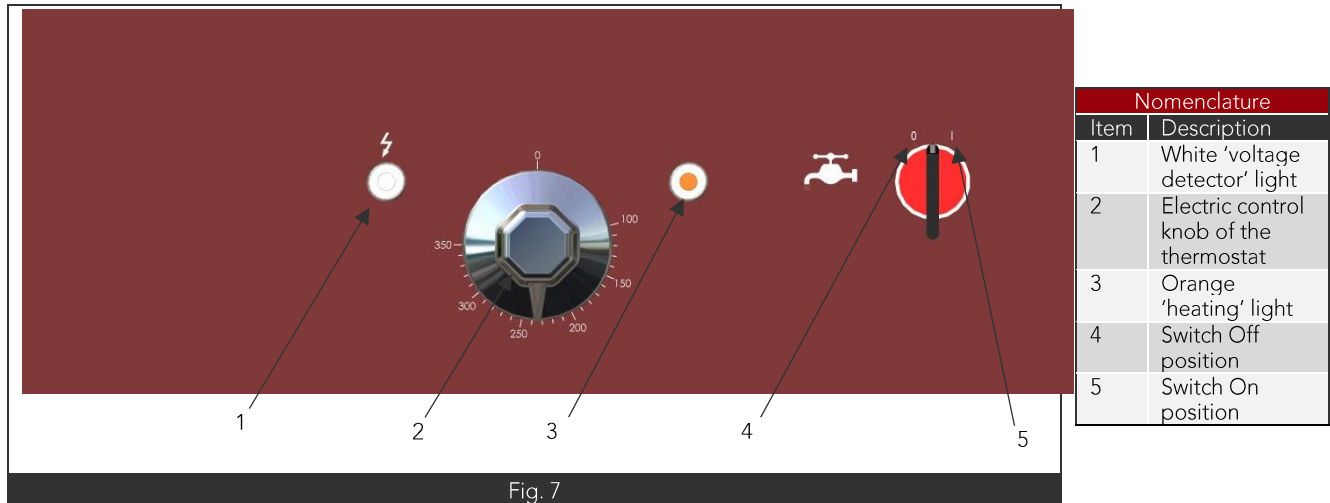

## 3. NORMAL USE OF THE PLANCHA

- With the appliance switched on, the white light is on (Fig. 7 Item 1).
- Move the run-off switch to the On position (Fig. 7 Item 5) to circulate water through the groove around the edge.
- Adjust the temperature of the thermostat using the electric control knob (Fig. 7 Item 2).
- The amber light comes on to indicate that the heating elements are heating (Fig. 7 Item 3) and goes off when they have reached the desired temperature.
- To stop the water run-off, turn the run-off switch to the Off position (Fig. 7 Item 4).

## 4. SWITCHING OFF

- Turn the control knob(s) to the '0' position.
- At the end of the day, shut off the electric power supply.

# ADJUSTMENTS – MAINTENANCE



WARNING

Instructions for maintenance operations on an electric appliance or for implementing electric power:

Before any work:

- Disconnect the appliance from its power supply at the circuit breaker.
- Use a suitable checking device to check that there is no voltage present.

*The rules laid down in the 'Electrical Connection' section remain applicable. In addition, all the maintenance operations listed below must be performed after the appliance has been powered off. Unless explicitly stated otherwise, tests following the replacement of a part must only be carried out once the appliance has been reassembled in its factory configuration.*



WARNING

Instructions for maintenance or adjustment operations on a gas-powered appliance or for implementing gas power:

- It is essential to stop the gas supply to the appliance in the case of work on one of the parts of the appliance's gas circuit (use the block valve provided for this purpose). This instruction does not apply to work that requires the presence of gas in the system (e.g. pressure check).
- Although our appliances are pre-set to suit the characteristics of the gas supply at the place of installation (type of gas, expected gas pressure), adjustments to the air setting may be necessary during installation.
- When checking the pressure, please take your measurement at the pressure gauge outlets on the manifolds and not at the gas taps.

*The rules laid down in the 'Gas Connection' section remain applicable. In addition, all the maintenance operations listed below must be performed after the block valve supplying the appliance has been shut off. Unless explicitly stated otherwise, tests following the replacement of a part must only be carried out once the appliance has been reassembled in its factory configuration.*

## 1. PERIODIC CHECKS

Under normal conditions of use, it is recommended to service the appliance once a year. In addition to checking the general operation of the appliance, this service should, include as a minimum:

- A check that the electrical and mechanical elements are in good working order.
- A check of the appearance of cables and connections (appearance, tightness).
- A check of the regulatory and safety components.
- Greasing of the gas taps

## 2. CONTROL PANEL REMOVAL

- Unclip the bottom of the panel.
- Pull it towards you and remove the panel.

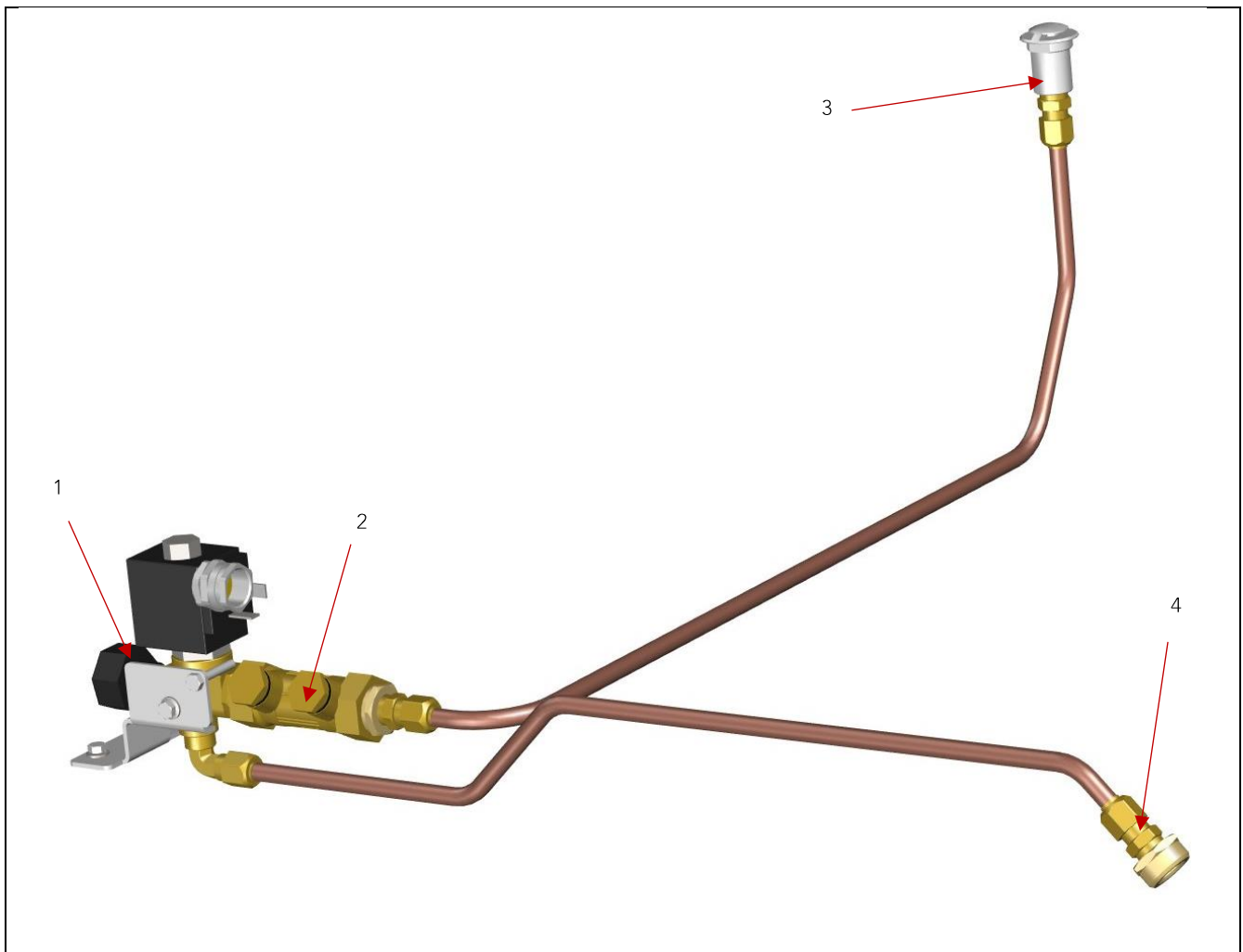

Fig. 8





## 6. WATER SUPPLY DIAGRAM



Item	Description	Code
01	Water solenoid valve	507650
02	Anti-pollution check valve	03935 A
03	Drain for plancha	505520
04	Male connector	07953 A

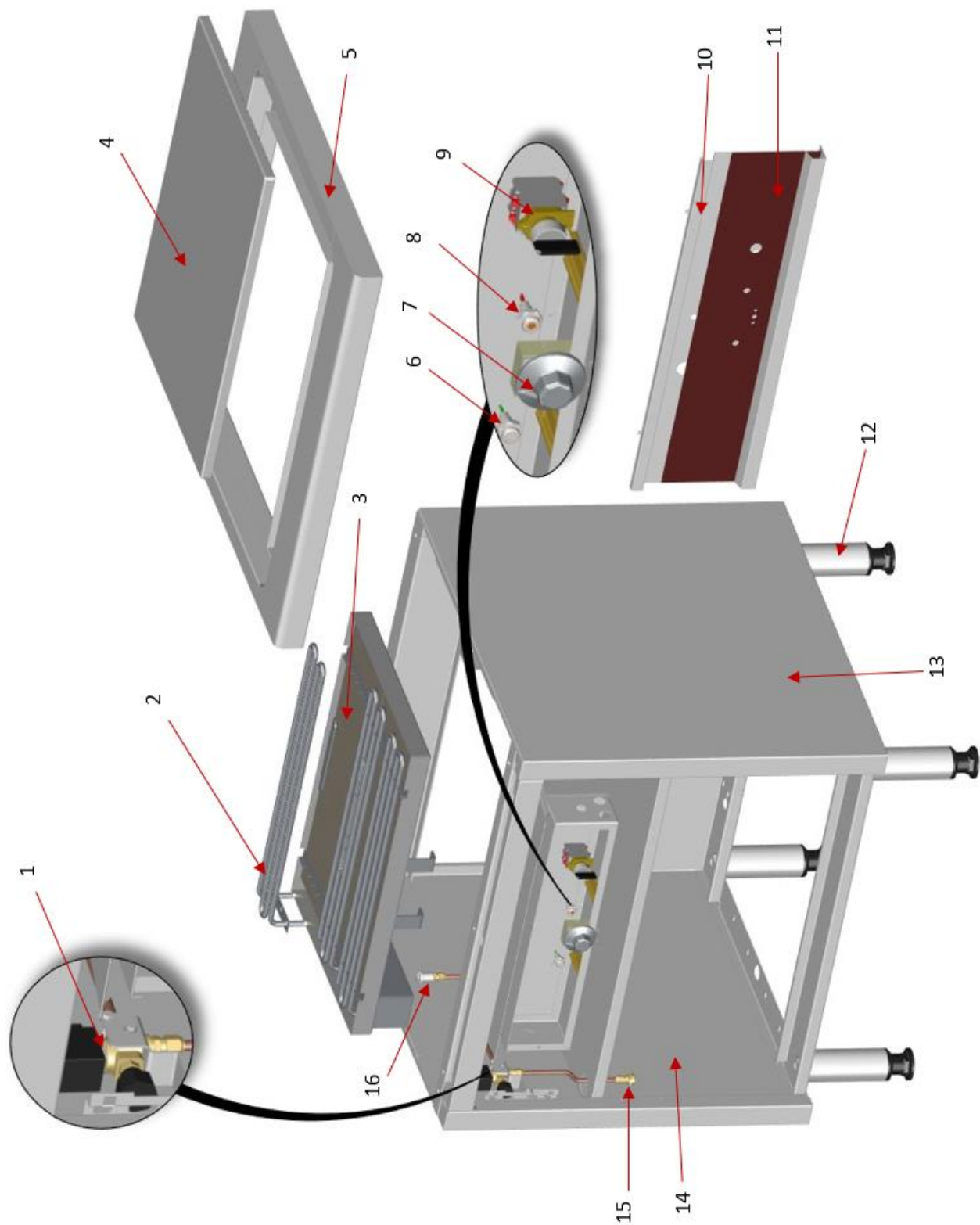

# EXPLODED VIEW











Item	Description	Code
01	Water solenoid valve	507650
02	Heating element 2500w	504847
03	Refractory element (x2)	100503 (single unit)
04	Steel plancha plate 700x500 Chrome plancha plate 700x500	505370 501042
05	Plancha top set	F12821
06	White 'voltage detector' light	173641
07	Electric control knob	501146
08	Amber light 230v	173640
09	Switch	02104 A
10	Stainless steel control cover	F12984
11	Enamel panel for plancha	501934
12	Standard legs height 180/200mm	F11290
13	Right side trim panel	103159
14	Left side trim panel	103158
15	Connector	07953 A
16	Drain for plancha	505520

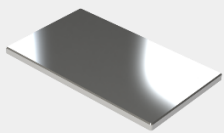

# SPARE PARTS

Code	Description	Photo
504847	Heating element plancha 700x500	
ELE0453	Heating element plancha 300x500	
173641	White light 230v	
501146	Electric control knob	
100503	Half-depth refractory bar	
172122	Plancha strainer	
507650	Water solenoid valve	

Code	Description	Photo
507441	Thermostat for plancha 700x500 100-450°	
01999 A	Thermostat for plancha 300x500 50-350°	
173640	Amber light 230v	
02104 A	Switch	
505370	Steel plancha plate 700x500	
503537	Steel plancha plate 300x500	
501042	Chrome plancha plate 700x500	
501058	Chrome plancha plate 300x500	
04762 A	Scrappy scraper	





PRO800-900

AUTHENTIC COOKING EQUIPMENT

# STEEL & CHROME ELECTRIC PLANCHA

## USER MANUAL

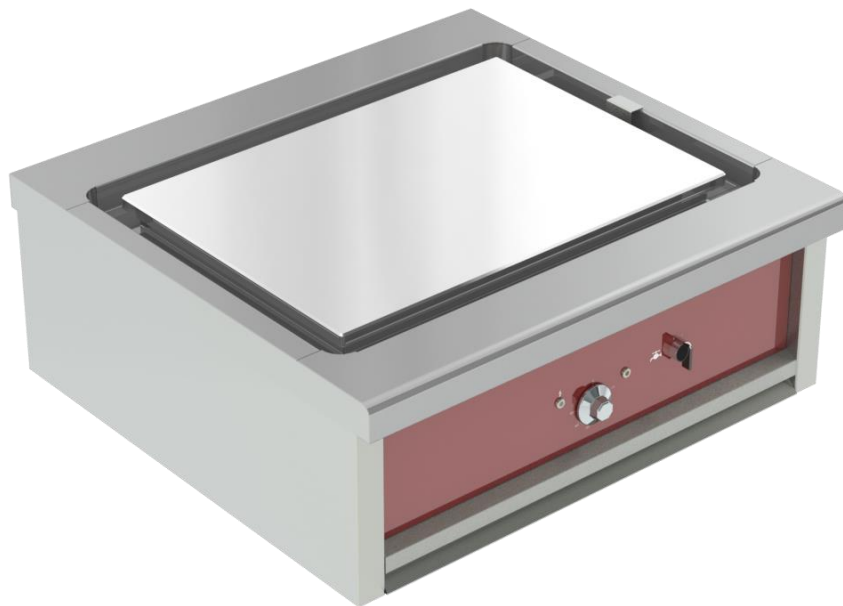

### USER MANUAL

FR\_PRO800-900\_PRO800-900 E-1  
PLANCHA ACIER ELECTRIQUE PRO800-  
900 E-1 PLANCHA CHROME  
ELECTRIQUE\_REV. A  
Written by JGD on 08/07/20  
Revised by JGD on 21/07/20

### APPLICABLE TO:

V03502	V03506	V03504	V03500	V03513
V03514	V03503	V03505		



# CONTENTS

---

INTRODUCTION	1
1. FOREWORD	1
2. USEFUL CONTACT DETAILS	1
3. WARRANTY	1
4. RESTRICTIONS ON USE	1
5. EQUIPMENT DISPOSAL	1
USE	2
1. WARNINGS	2
2. CONTROL PANEL PLANCHA 700X500	2
3. NORMAL USE	2
4. SWITCHING OFF	2
CLEANING & MAINTENANCE	3
1. WARNINGS	3
2. CLEANING THE OUTER SURFACES	3
3. CLEANING THE STEEL PLATE	3



# REVISION HISTORY

---

Revision index	Author of the revision	Date of the revision	Nature of the revision
B	JGD	09/07/2020	Update and addition of run-off as standard



# INTRODUCTION

## 1. FOREWORD

Thank you for choosing Charvet equipment for your installation. Our equipment is designed and manufactured in France by our teams, who are committed to meeting five targets: Robustness, performance, hygiene, ergonomics, and safety.

If, however, despite our commitment and effort, you encounter a problem with one of our products, please get in touch with our After-sales service.

## 2. USEFUL CONTACT DETAILS

For any information, or sales request:

✉ [info@charvet.fr](mailto:info@charvet.fr)

☎ +33 (0)4 76 06 64 22

For all technical assistance requests, contact our After-sales service department:

✉ [sav@charvet-sa.fr](mailto:sav@charvet-sa.fr)

☎ +33 (0)4 76 06 68 14

## 3. WARRANTY



INFORMATION

The warranty is part of the sale contract. For any installation or work carried out under the warranty, contact an authorised dealer. In addition, we would like to remind you that the CHARVET warranty does not cover damage caused by faulty installation, misuse or inadequate maintenance. Please read this manual in full.

## 4. RESTRICTIONS ON USE



INFORMATION

This appliance should only be used by qualified persons. The installer should provide training on how to use the appliance once it has been installed. After the user training, the User Manual (below) must be passed to the final user for their records.

CHARVET equipment should not be used by untrained personnel unless they are under the supervision of a person who is liable and can guarantee their safety.

## 5. EQUIPMENT DISPOSAL



INFORMATION

### Exclusively for France:

In accordance with Decree No. 2014-928 of 19 August 2014, concerning the disposal of waste and electrical and electronic equipment, the Paul CHARVET company is responsible for the organisation and financing of the collection and processing of professional EEE placed on the market from 13.08.2005. As such, the CHARVET company is a member of ECOLOGIC, an eco-organisation approved by the state.

### How WEEE is disposed of:

At the end of its life, the equipment must be palletised and made available to the carrier in an accessible place. Except in exceptional circumstances, the equipment shall not have been dismantled, even partially. Otherwise, the CHARVET company reserves the right to re-invoice the costs of processing and taking responsibility for the equipment.

In addition, all requests weighing less than 500 Kg shall either be dropped off by the end user at a collection point or collected from the end user's premises, in which case the end user will be liable to pay the cost of such collection.

### For any request for collection:

[www.e-dechet.com](http://www.e-dechet.com)

+33 (0)1 30 57 79 14



## 1. WARNINGS



WARNING

This appliance is intended for professional use, and should therefore be used by qualified personnel, as intended and as instructed in this document.  
Any abnormal use of this equipment could have consequences on its operation, but also on the safety of property and persons.  
This appliance is equipped with several safety devices. In case of malfunction, please cut off all supplies (electricity, gas, water, etc.) and contact a qualified installer for repair.

- Do not attempt to repair a defective appliance by yourself, in case of malfunction, please isolate the device (cut off its supplies, and limit access to the appliance to authorised persons only), pending the work by the installer.
- Do not use an appliance when it has gone into safe mode, do not attempt to bypass its safety device(s).
- Never use an appliance, especially when empty, without supervision.
- This equipment should be revised at least once a year by a qualified installer.
- Some parts of this appliance are protected by the manufacturer, in case of a fault, contact the installer for replacement or repair.

Neither the CHARVET company nor the installation company shall be liable for damage and/or injuries resulting from improper maintenance, misuse, or unauthorised modification of this appliance.

## 2. CONTROL PANEL PLANCHA 700x500

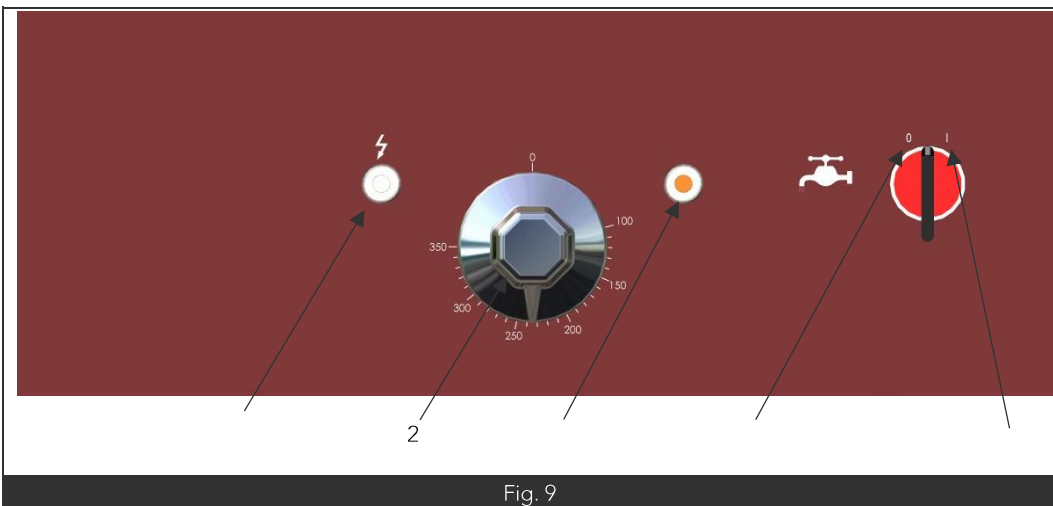

Fig. 9

Nomenclature	
Item	Description
1	White 'voltage detector' light
2	Electric control knob of the thermostat
3	Orange 'heating' light
4	Switch Off position
5	Switch On position

## 3. NORMAL USE

- With the appliance switched on, the white light is on (Fig. 9 Item 1).
- Move the run-off switch to the On position (Fig. 9 Item 5) to circulate water through the groove around the edge.
- Adjust the temperature of the thermostat using the electric control knob (Fig. 9 Item 2).
- The amber light comes on to indicate that the heating elements are heating (Fig. 9 Item 3) and goes off when they have reached the desired temperature.
- To stop the water run-off, turn the run-off switch to the Off position (Fig. 9 Item 4).

## 4. SWITCHING OFF

- Turn the control knob(s) to the '0' position.
- At the end of the day, shut off the electric power supply.

# CLEANING & MAINTENANCE

## 1. WARNINGS



WARNING

Before cleaning the appliance, make sure that the parts to be handled have cooled down or equip yourself with suitable protection.

It is preferable to clean and maintain this equipment after switching it off.

This appliance must not be cleaned by means of water spray, water jets under pressure or steam.

The use of bleach and/or acid, even heavily diluted, is absolutely prohibited.



WARNING

The solid top is heavy and does not need to be lifted during normal use of the appliance.

## 2. CLEANING THE OUTER SURFACES

- Turn off and wait until the elements near the plate have cooled down.
- After each service and before cleaning, we strongly advise you to disconnect the gas supply and turn appliances off.
- Wash with a sponge in soapy water or any other neutral cleaning product.
- After each cleaning, rub with an oily rag.

## 3. CLEANING THE STEEL PLATE

- If scraping is necessary, this should be done while the appliance is warm and using a Scrappy scraper, which is not supplied with the equipment (see reference in the spare parts list).
- Never clean a steel plate by deglazing.
- Dry the plate thoroughly after cleaning to avoid any risk of rust forming and then wipe with an oily cloth after drying.

**Note:** Clean the drain hole regularly with a small cleaning brush or similar tool.

## 4. CLEANING THE CHROME PLATE

The first part of the cleaning will be carried out before the appliance is disconnected from the mains, while warm:

- Remove the largest pieces of waste from the plate using a spatula.
- Proceed by deglazing (FORBIDDEN ON A STEEL PLATE) the plate, then use the scraper provided to push the waste along the drainage groove.
- If necessary, it is also possible to clean the plate further using a wooden spatula and a Tampico brush.
- Empty the contents of the groove into the drain.







For the second part, disconnect the appliance from the mains:







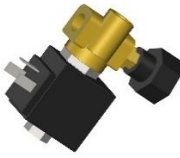

- Remove the strainer and clean it, trying to remove as much burnt grease as possible from around it.
- Finish cleaning the drainage groove using a sponge and soapy water.
- For appliances equipped with one, remove the grease tank and empty out the larger pieces of waste.
- The tank can then be cleaned with a sponge and soapy water.
- If the drainage groove is blocked, clean it with a small cleaning brush.

**Note:** Clean the drain hole regularly with a small cleaning brush or similar tool.

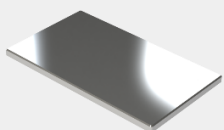

# SPARE PARTS

Code	Description	Photo
504847	Heating element plancha 700x500	
ELE0453	Heating element plancha 300x500	
173641	White light 230v	
501146	Electric control knob	
100503	Half-depth refractory bar	
172122	Plancha strainer	
507650	Water solenoid valve	

Code	Description	Photo
507441	Thermostat for plancha 700x500 100-450°	
01999 A	Thermostat for plancha 300x500 50-350°	
173640	Amber light 230v	
02104 A	Switch	
505370	Steel plancha plate 700x500	
503537	Steel plancha plate 300x500	
501042	Chrome plancha plate 700x500	
501058	Chrome plancha plate 300x500	
04762 A	Scrappy scraper	