



Module E4PCF-4ZONES



Description	800	900
OVEN E4PCF-4ZONES	V03231	V03234
B-E4PCF-4ZONES	V03232	V03235
R-E4PCF-4ZONES	V03233	V03236



Installation manual



Module E4PCF-4ZONES



CONTENTS

1	INSTALLATION.....	4
1.1	GENERAL POINTS	4
1.2	HANDLING - INSTALLATION	4
1.3	INSTALLATION	4
1.4	DATA PLATE.....	4
2	ELECTRICAL CONNECTION	5
2.1	CHECKS BEFORE CONNECTION	5
2.2	ELECTRICAL CONNECTION	5
2.3	CHECKS AFTER CONNECTION	5
3	STARTING UP	5
	REFER TO THE USER MANUAL SECTION ON STARTING UP THE APPLIANCE FOR THE FIRST TIME.	5
4	MAINTENANCE– SERVICING	5
4.1	BAY CABINET/WARMER WIRING DIAGRAMS	5
4.2	OVEN WIRING DIAGRAMS	6
4.3	BASIC EMERGENCY SPARE PARTS	7



Module E4PCF-4ZONES



‘Compliance with French Decree No. 2014-928 of 19 August 2014.’

Exclusively for France

In accordance with Decree No. 2014-928 of 19 August 2014, concerning the disposal of waste electrical and electronic equipment, CHARVET ensures the organisation and financing of the collection and processing of professional WEEE placed on the market after 13/08/2005 or when replacing such equipment with equipment that is the equivalent or performs the same function. As such, the CHARVET company is a member of ECOLOGIC, an eco-organisation approved by the State. The equipment should be palletised and ready for loading in a place that is accessible by the carrier. Except in exceptional circumstances, the equipment shall in no case have been dismantled, even partially, otherwise CHARVET reserves the right to re-invoice the costs of processing and taking responsibility for the equipment.

Disposal of WEEE

For any request for collection, contact:

- ➔ www.e-dechet.com
- ➔ +33 (0)1 30 57 79 14.

All requests weighing less than 500 kg shall either be dropped off by the end user at a collection point or collected from the end user's premises, in which case the end user will be liable to pay the cost of such collection.





Module E4PCF-4ZONES



1 INSTALLATION

1.1 General points

The equipment must be installed in a room with adequate ventilation, equipped with an air extraction system, according to best practice and in accordance with the instructions in this manual and the regulations in force in the country of installation.

Special attention should be paid to the local fire prevention regulations of the establishment concerned.

Please train every user in the operation of this appliance after installation.

The user manual must be handed over to the user after installation.

Any intervention or repair on an appliance must be undertaken by a qualified installer.

WARRANTY: The warranty is part of the sale contract. This warranty does not cover any damages due to faulty installation, misuse or inadequate maintenance.

1.2 Handling - Installation

The appliance must remain on its wooden pallet during the handling process until the final installation. Unpack and check the appliance for damage upon receipt.

In case of damage, detail it immediately on the delivery note; notify the carrier by registered mail with acknowledgement of receipt within 48 hours.

1.3 Installation

It is essential to install this appliance under an extractor hood.

If the appliance is to be installed against a wall or partition, near a piece of furniture or decorative borders, it is recommended that these are made of fireproof material. If this is not the case, they must be protected by an approved fireproof, insulating material. In case of doubt regarding materials, allow a 10 cm space around your appliance.

Remove all protective plastic wrapping from the outer panels.

Install the appliance in its place of use.



- **Fixed appliance:**

Fit the legs (these are delivered in a separate box).

Level the appliance by adjusting the height of the legs to obtain a horizontal working surface height of 900 mm.

- **Mobile appliance:**

The brakes on the castors must be in locked position when the appliance is in position for connection and throughout its use.

The anti-wrench device must be installed

1.4 Data plate

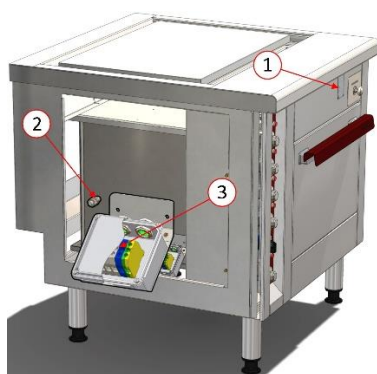

Figure A

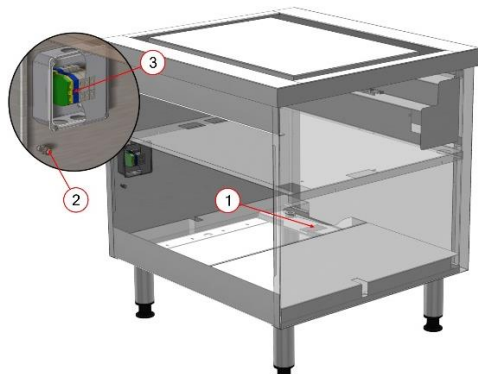

Figure B

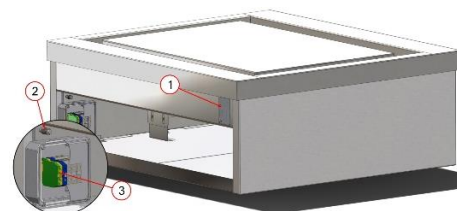

Figure C

Each appliance has a data plate (Figures A, B, C Item 1).



Module E4PCF-4ZONES



2 ELECTRICAL CONNECTION



The appliance must be earthed
It is dangerous to put the appliance into service without connecting it to earth
Use standard cable (245 IEC 57 or 245 IEC 66) or other cables with the same characteristics.
Ensure that the user's fixed installation has an all-pole circuit breaker with point gap in compliance with standard EN 60335- 1



Mobile appliances are equipped with an electrical plug of the correct wattage. This plug must be accessible at all times.
Caution: Connect the equipotential terminal (Figures A, B, C Item 2).

2.1 Checks before connection

Before switching on the appliance, make sure:

- That the electrical voltage of the supply is compatible with the voltage and wattage of the appliance.
- That the cable is fixed correctly.
- That the appliance's connections are tight.
- That the cable section is compatible with the voltage of the appliance.

2.2 Electrical connection

Connect the appliance to the terminal block in accordance with the instructions on the box label (Figures A,B,C Item 3 and Figure D). Connect the appliance to the equipotential terminal (Figure A,B,C Item 2).

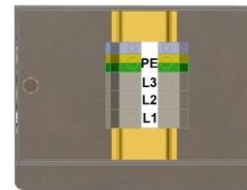

Figure D

2.3 Checks after connection

After connection, check:

- That the appliance is correctly earthed, (see warnings).
- The insulation of the electrical equipment.
- The correct operation of the appliance and the safety components.

3 STARTING UP

Refer to the user manual section on starting up the appliance for the first time.

4 MAINTENANCE– SERVICING



Any intervention or repair on an appliance must be undertaken by a qualified installer.
The appliance will be isolated from the electrical power supply and locked out/tagged out for the duration of the intervention.

4.1 Bay cabinet/Warmer wiring diagrams

Item	Description	Code	Item	Description	Code
L1-L2-L3	Viking terminal 10 mm ²	02468 A	H3	Red indicator light 400V (Heating)	173644
PEN	Viking earth terminal 10 mm ²	03575 A	RE	4-ZONE PCF heating element 3000W	502286
H1	White 'voltage detector' indicator light	173646	TH TRI	Thermostat 50°-500° (regulation)	505641



Module E4PCF-4ZONES

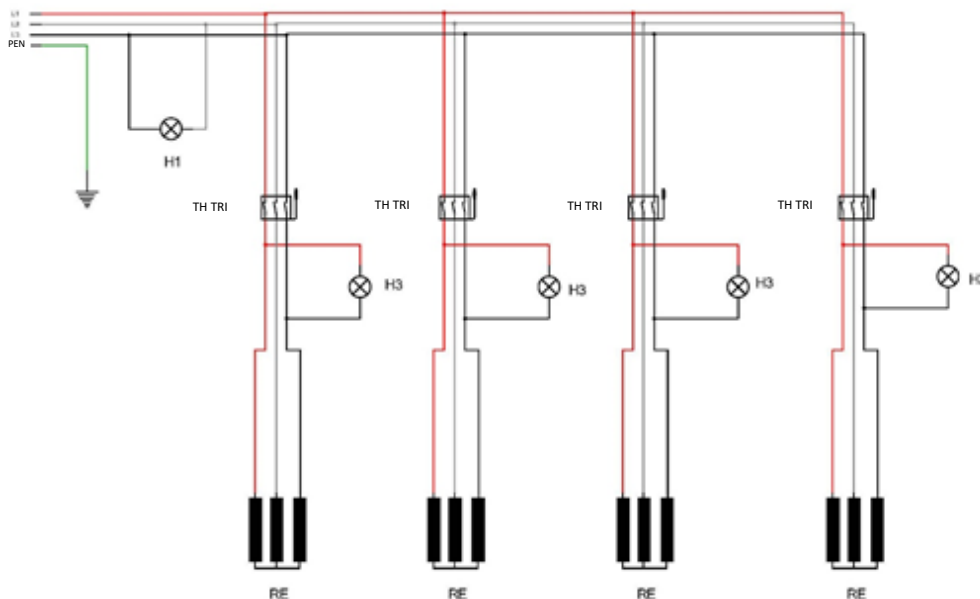

Item	Description	Code	Item	Description	Code
L1-L2-L3	Viking terminal 10 mm ²	02468 A	H3	Amber indicator light 400V (Heating)	173645
PEN	Viking earth terminal 10 mm ²	03575 A	H3-FV		
H1	White 'voltage detector' indicator light	173646	H3-FS		
RE	4-zone PCF heating element 3000W	502286	TH TRI	Thermostat 50°500° (regulation)	505641

4.2 Oven wiring diagrams

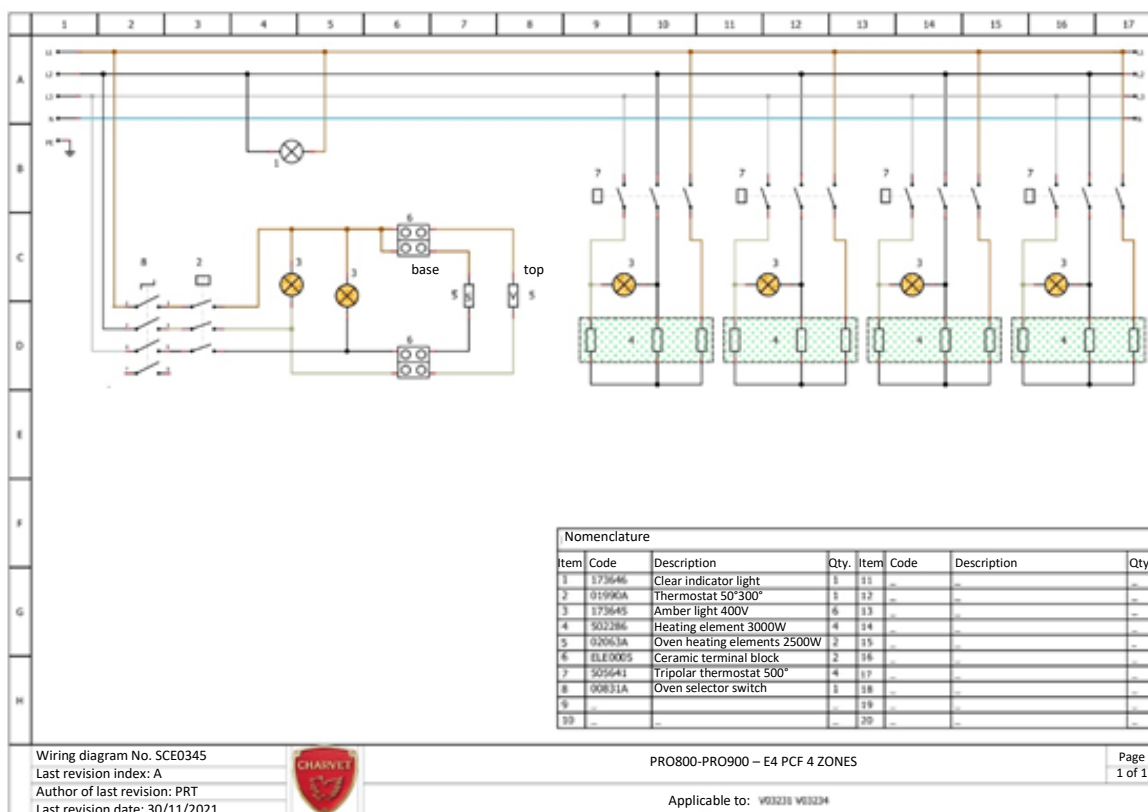









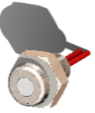





Module E4PCF-4ZONES

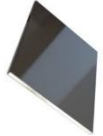

Basic emergency spare parts

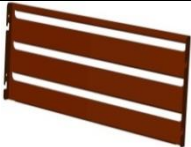
Code	Description	Code	Description	Code	Description
173646		173645		501146	
White indicator light 400V		Amber indicator light 400V		Electric control knob	
505641		00831 A		01990 A	
Tripolar thermostat 50-500°C		Oven switch		Thermostat 50°-300°C (Oven)	
502286		04051 A		02063 A	
Heating element 3000W		Stainless steel oven shelf		Oven heating element 2500W 400V	
505370		04128 A		F06099	
Steel plate PCF4 ZONES		Double torsion spring		Oven base	
		F10945		F14219	
		Oven door handle		Oven shelf runner	



Module E4PCF-4ZONES



Description	800	900
E4PCF-4ZONES OVEN	V03231	V03234
B-E4PCF-4ZONES	V03232	V03235
R-E4PCF-4ZONES	V03233	V03236



User manual



Module E4PCF-4ZONES



CONTENTS

1	INTRODUCTION.....	4
2	CONTROL PANEL	4
3	BEFORE STARTING UP FOR THE FIRST TIME.....	4
4	STARTING UP	5
4.1	WARNING	5
4.2	USE.....	5
5	SWITCHING OFF	5
6	MAINTENANCE.....	5
6.1	CLEANING	5
6.2	CLEANING THE STAINLESS STEEL OUTER SURFACES AND THE DRIP TRAY	5
6.3	CLEANING THE OVEN	6
6.4	CLEANING THE STEEL PLATE.....	6
6.5	PRACTICAL CLEANING TIPS	7
7	BASIC EMERGENCY SPARE PARTS.....	7



Module E4PCF-4ZONES



‘Compliance with French Decree No. 2014-928 of 19 August 2014.’

Exclusively for France

In accordance with Decree No. 2014-928 of 19 August 2014, concerning the disposal of waste electrical and electronic equipment, CHARVET ensures the organisation and financing of the collection and processing of professional WEEE placed on the market after 13/08/2005 or when replacing such equipment with equipment that is the equivalent or performs the same function. As such, the CHARVET company is a member of ECOLOGIC, an eco-organisation approved by the State. The equipment should be palletised and ready for loading in a place that is accessible by the carrier. Except in exceptional circumstances, the equipment shall in no case have been dismantled, even partially, otherwise CHARVET reserves the right to re-invoice the costs of processing and taking responsibility for the equipment.

Disposal of WEEE

For any request for collection, contact:

- ➔ www.e-dechet.com
- ➔ +33 (0)1 30 57 79 14.

All requests weighing less than 500 kg shall either be dropped off by the end user at a collection point or collected from the end user's premises, in which case the end user will be liable to pay the cost of such collection.





Module E4PCF-4ZONES



1 INTRODUCTION



Our appliances are intended for professional use and should be used by qualified personnel.

Any modifications to existing equipment or any new installations must be carried out by a qualified installer.

WARRANTY: The warranty is part of the sale contract. For any work to be carried out under the warranty, please contact an authorised dealer. This warranty does not cover any damages due to faulty installation, misuse or inadequate maintenance.

2 CONTROL PANEL

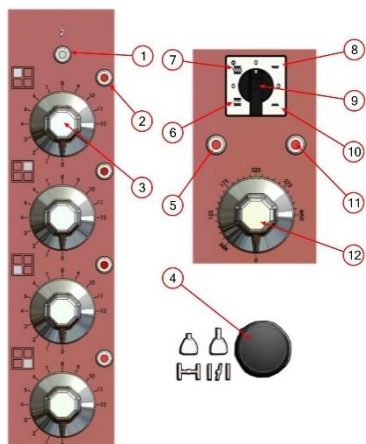

Figure E

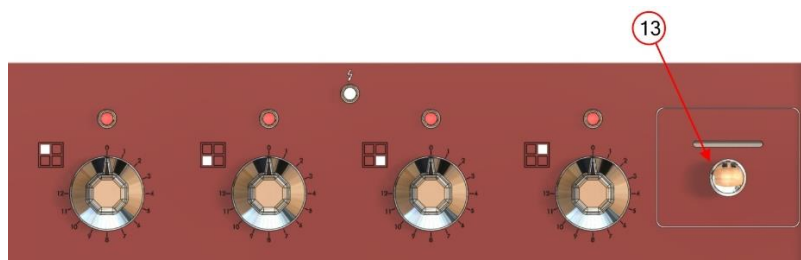

Figure F

Item	Description		
1	White 'voltage detector' indicator light	7	Top/Base intense
2	Red indicator light (Heating)	8	Top
3	4-zone PCF control knob	9	Electric oven switch
4	Damper (pulled out = open / pushed in = closed)	10	Base
5	Red indicator light 400V (Top in operation)	11	Red indicator light 400V (Base in operation)
6	Top/Base gentle	12	Electric oven thermostat 50°-300°C
		13	Drip tray

3 BEFORE STARTING UP FOR THE FIRST TIME



Procedure for preparing the steel plate

Pour oil over the entire plate and heat it.

Once the oil is smoking slightly, wipe the plate with absorbent paper.

Allow it to cool completely.

Repeat this procedure 3 times to form a sufficiently strong and thick non-stick layer.

- Prior to starting up for the first time, it is advisable to clean the appliance in order to eliminate all dust or impurities that have accumulated during storage.
- Remove all protective plastic wrapping from the stainless steel parts.
- Ensure that the control elements are in good working order.



Module E4PCF-4ZONES



4 STARTING UP

4.1 WARNING



During operation, and depending on how long it is in service, the drainage tray may become hot.

Wait for the appliance to cool down before handling the drainage tray.
If necessary during the service, use adequate protection and inform users of the potential risk of burning.



When opening the oven door during 'wet' cooking, beware of escaping steam, there is a risk of burning.

The oven's walls and door may be very hot after intensive or prolonged use, always use the handle only when opening and closing the door and stand well back.

4.2 Use

With the device switched on:

- Turn the control knob to the desired position (Figure E Item 3).
- The red indicator light comes on (sign that it is in operation) (Figure E Item 2).
- While the appliance is heating up, you will have to wait about 10 - 15 minutes before starting to cook.

5 SWITCHING OFF

Turn the control knob(s) to the '0' position.

6 MAINTENANCE



For best results, have your equipment serviced and cleaned regularly by a qualified installer.

Contact the supplier to replace any faulty control components before further use.
The manufacturer and the installer cannot be held liable if the user does not make a request for repairs due to malfunctions.



Caution: Some parts are factory-sealed by the manufacturer. In case of fault, call a qualified installer.

6.1 Cleaning



Remember to stop heating the plates before each cleaning.
Be careful, the plates remain hot.



**This appliance must not be cleaned by means of water spray or water jets under pressure.
Check that the appliance is disconnected at the mains.**

6.2 Cleaning the stainless steel outer surfaces and the drip tray.

- Switch off the appliance. After each service and before each cleaning operation, we strongly advise you to disconnect the appliance from the mains.
- Wash with a sponge in soapy water (or any other neutral cleaning product).
- After each cleaning, rub with an oily rag.
- Do not use bleach or any acid, even if heavily diluted.



Module E4PCF-4ZONES



6.3 Cleaning the oven



Figure G

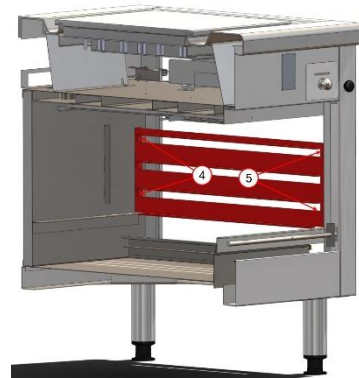

Figure H

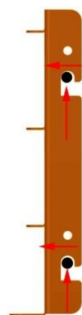

Figure I

To clean the oven components:

- Open the oven door
- Remove the oven shelf (**Figure G** Item 1)
- Remove the oven base (**Figure G** Item 3)
- To remove the shelf runners (**Figures G, H** Items 4, 5)

Then lift and pull the shelf runner from the side (**Figure I**).

In order to avoid the release of fumes due to stains and residues of fats and food, frequent cleaning of all the oven walls is recommended.

- The base can be removed so that it and the burner housing can be cleaned.
- The shelf runners can also be taken out for hand washing.

Clean the oven with a moist sponge and a neutral detergent.

Rinse after cleaning, dry all parts, and put them back in the reverse order to removal.

6.4 Cleaning the steel plate

- Wash the plate with a sponge and warm water.
- If scraping is necessary, this should be done while the appliance is warm and using a brass brush or an abrasive sponge, which are not supplied with the equipment.
- Do not use detergents.
- Never clean a cast iron solid top by deglazing.
- To avoid oxidation, dry the plate well, then put a little food-grade oil on the whole plate and wipe with absorbent paper.



Module E4PCF-4ZONES



6.5 Practical cleaning tips



Do not allow the plate to overheat when not in use.
Clean the drain hole regularly with a small cleaning brush or similar tool.

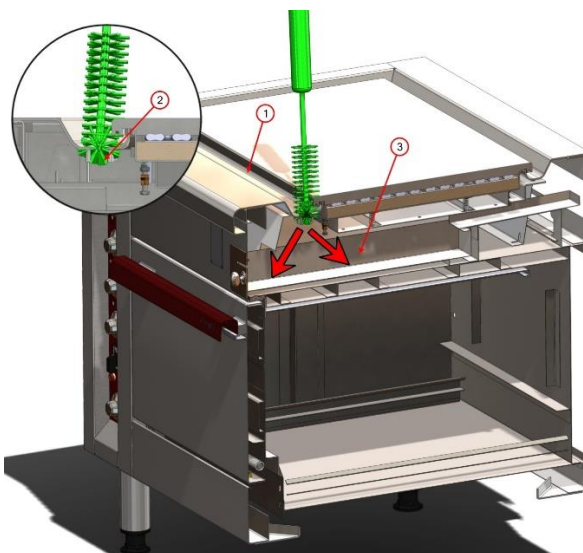

Figure J

The groove around the edge (Figure j Item 1) collects residues of food and grease.
It is recommended that large pieces of waste should be collected with a spatula to reduce the risk of obstruction of the appliance's drain (Figure J Item 2).
Periodically empty the drip tray (Figure J Item 3).





7 Basic emergency spare parts

Code	Description	Code	Description	Code	Description
173646		173644		501146	
White indicator light 400V		Red indicator light 400V		Electric control knob	
505641		00831 A		01990 A	
Tripolar thermostat 50-500°C		Oven switch		Thermostat 50°-300°C (Oven)	
502286		04051 A		02063 A	
Heating element 3000W		Stainless steel oven shelf		Oven heating element 2500W 400V	

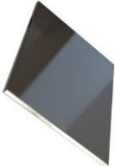

Module E4PCF-4ZONES



Code	Description	Code	Description	Code	Description
505370		04128 A		F06099	
Steel plate PCF4 ZONES		Double torsion spring		Oven base	
		F10945		F14219	
		Oven door handle		Oven shelf runner	