



Gas-powered tilting bratt pans

DESCRIPTION	MODULAR PRO 900
G1SBE 50 AERO	V02964
G1SBE 50EL AERO	V02972
G1SBE 75 AERO	V03014
G1SBE 75EL AERO	V03012



Installation manual

CHARVET

F-38850 – CHARAVINES
Tel.: (33)-4-76-06-64-22
Fax: (33)-4-76-55-78-75
Email: info@charvet.fr
Email: sav@charvet-sa-fr



MANUAL: Pro 900 FR GSBEL50
ind.: B; Date created: 10/09/2010
Updated on: 25/03/2011 Manual
code:

'Compliance with French Decree No. 2005-829 of 20 July 2005.'

Exclusively for France

A - In accordance with Article 18 of Decree No. 2005-829 of 20 July 2005 on the disposal of waste electrical and electronic equipment, the Paul CHARVET company takes responsibility for the financing and organisation of the disposal of its waste. As such, the Paul CHARVET company resumes full ownership of the electrical and electronic equipment at the end of its life..

The equipment should be palletised and ready for loading in a place that is accessible by the carrier. Except in exceptional circumstances, the equipment shall in no case have been dismantled, even partially, otherwise CHARVET reserves the right to re-invoice the costs of processing and taking responsibility for the equipment.

B- How WEEE is disposed of:

The terms and conditions of disposal are covered by the SYNEG/RECYSTEM-PRO agreement, which states that: "In order to fulfil their obligations, the producers of electrical and electronic equipment for large kitchens grouped within the SYNEG, have implemented arrangements for the collection and processing/recycling of WEEE in accordance with the provisions of the decree.

Materials or substances harmful to the environment (such as refrigerants or foams) are extracted or separated. The metal fractions (stainless steel, zinc, copper, etc.) are crushed and transported to refiners for reuse. Therefore, when you need to have electrical equipment collected by a SYNEG professional kitchen equipment manufacturer, you must contact RECYSTEM-PRO, the operator chosen for the management of WEEE

- ↳ at this telephone number: 01 45 01 71 43.
- ↳ or at the following e-mail address: synergdeee@recystempro.com

You will then be sent a collection request sheet which will contain the following elements:

- name of the producer of the equipment
- type of equipment
- estimated weight
- place of collection
- name and contact details of the installer
- invoicing address

After verification with the producer and obtaining its agreement, RECYSTEM-PRO will proceed with the collection."

"This device complies with the 2009/142 (Declaration of conformity to type) directive"



Contents

<u>INSTALLATION MANUAL</u>	1
1. <u>INSTALLATION</u>	4
1.1. GENERAL	4
1.2. HANDLING- POSITIONING	4
1.3. INSTALLATION	4
1.4. DATA PLATE	5
1.5. MOUNTING THE FLUE	5
2. <u>GAS CONNECTION</u>	6
2.1. CHECKS BEFORE CONNECTION	6
2.2. CONNECTING THE APPLIANCE TO THE GAS SUPPLY	7
2.3. CHECKS AFTER CONNECTION	7
2.4. CONTROL OF SUPPLY PRESSURE	8
3. <u>ADAPTING THE APPLIANCE TO DIFFERENT TYPES OF GAS</u>	9
3.1. CHANGING INJECTORS AND AIR ADJUSTMENTS	9
3.2. GAS SETTINGS TABLE	10
4. <u>ELECTRICAL CONNECTION</u>	10
4.1. CHECKS BEFORE CONNECTION	11
4.2. CONNECTING THE APPLIANCE TO THE ELECTRICITY SUPPLY	11
4.3. CHECKS AFTER CONNECTION	11
4.4. TABLE OF ADAPTATIONS TO DIFFERENT SUPPLY VOLTAGES	11
5. <u>WATER CONNECTION</u>	12
5.1. MOUNTING THE SOLENOID VALVE	13
5.2. CHECKS AND INSPECTIONS AFTER WATER CONNECTION	14
6. <u>LIST OF EMERGENCY PARTS</u>	14
7. <u>WIRING DIAGRAMS FOR OPTIONS</u>	16

1. INSTALLATION

1.1. General

The equipment must be installed in a room with adequate ventilation, equipped with an air extraction system, according to the regulations and standards in force in the country of installation and the instructions contained in this manual..

This appliance is an A-type and must not be connected to a flue gas pipe.

The user manual must be handed over to the user after installation.

1.2. Handling - Positioning

It is imperative to leave the appliance on its wooden pallet during the handling process until the final installation. Unpack and check the appliance for damage upon receipt.

In case of damage, detail it immediately on the delivery note; notify the carrier by registered mail with acknowledgement of receipt within 48 hours.

1.3. Installation

Special attention should be paid to the local fire prevention regulations of the establishment (see regulations applicable to establishments that are open to the public.)

The appliance must be installed under an extraction hood.

If the appliance is to be installed against a wall or partition, near a piece of furniture or decorative borders, it is recommended that these are made of fireproof material.

If this is not the case, they must be protected by an approved fireproof, insulating material.

In case of doubt regarding materials, allow a 10 cm space around your appliance.

Remove all protective plastic wrap from the outer panels.

Install the appliance in its place of use.

Warning



Fixed appliance:

- Check that the plinth is horizontal.
- Level the appliance by adjusting the height of the legs to obtain the height of the horizontal worktop.

• Mobile appliance:

Fit the castors (these are delivered in a separate box).

The brakes on the castors must be in locked position when the appliance is in position for connection and when the cooking function is in operation.

**Any intervention or repair on an appliance must be undertaken by a qualified installer.
The apparatus will be isolated from the gas supply by closing the gas valve.**

When the installation is complete, train users on the proper use of the appliance (see the user manual).

Warranty: the warranty is part of the sale contract.

This warranty does not cover any damages due to faulty installation, misuse or inadequate maintenance.

1.4. Data plate

Each appliance has a data plate. Record the information on this plate on the last page of the user manual. This will make it easier for you to communicate with your customer for better service delivery.

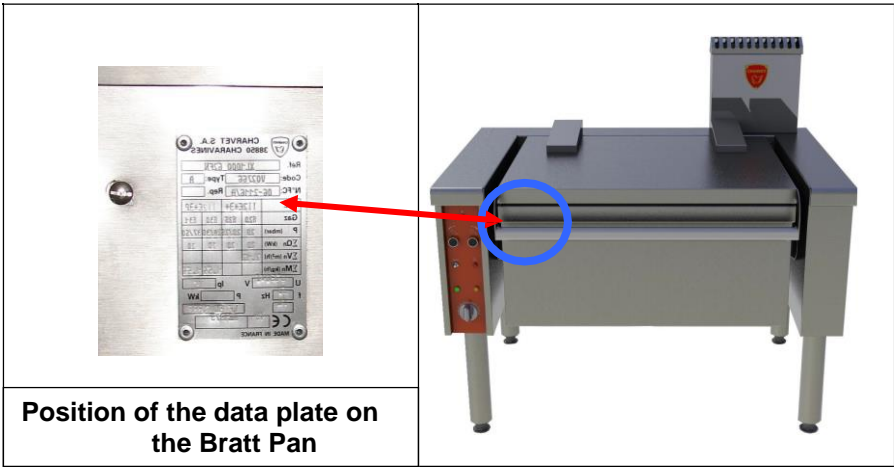

1.5. Mounting the flue

Attach the discharge flue to the top of the appliance and make sure that nothing is clogging the flue (inside/outside).

- Description:

<p>Two fixing screws, on the right and the left, can be reached from the top of the flue. (Fig.1) and (Fig.2)</p>	<p style="text-align: center;">Fig. 1</p>
<p>Remove the screws to lower the retaining tabs under the flue on the left and right sides. (Fig.3)</p>	<p style="text-align: center;">Fig. 2</p>
<p>Place the flue above its housing, slide the retaining tabs under the top, and reposition the tabs by refitting the screws mentioned above. (Fig.2)</p>	<p style="text-align: center;">Fig. 3</p>

2. GAS CONNECTION

Warnings:

- **Fixed appliance:**

Connect the appliance (" male pipe threaded for gas) to the fixed gas supply pipe, inserting a block valve so that the appliance can be isolated from the rest of the installation.

- **Mobile appliance:**

Connect the appliance (" male pipe threaded for gas) to the fixed gas supply pipe using an authorised gas hose, inserting a block valve so that the appliance can be isolated from the rest of the installation. (*Install the anti-wrench system*).

2.1. Checks before connection

Check:

- The cleanliness of the pipeline,
- That the gas supply pipeline is correctly sized so as to minimise pressure drops, the diameter being determined according to the power of the appliance, the gas pressure, the path travelled (length and number of elbows).
- That the new air flow to supply combustion is 2 X m³/h/kW (see tables).
- The type of gas used: check that the appliance is set for the type of gas delivered to the installation (type/pressure), this information is on the label near the gas connection.

Table			
Code	Appliance type	Power (kW)	Required new air flow (in m ³ /h/ kW)
V02964	G1SBE 50	25	50
V02972	G1SBE 50-EL	25	50
V03014	G1SBE 75	37.5	75
V03012	G1SBE 75 EL	37.5	75

2.2. Connecting the appliance to the gas supply

Fig.1

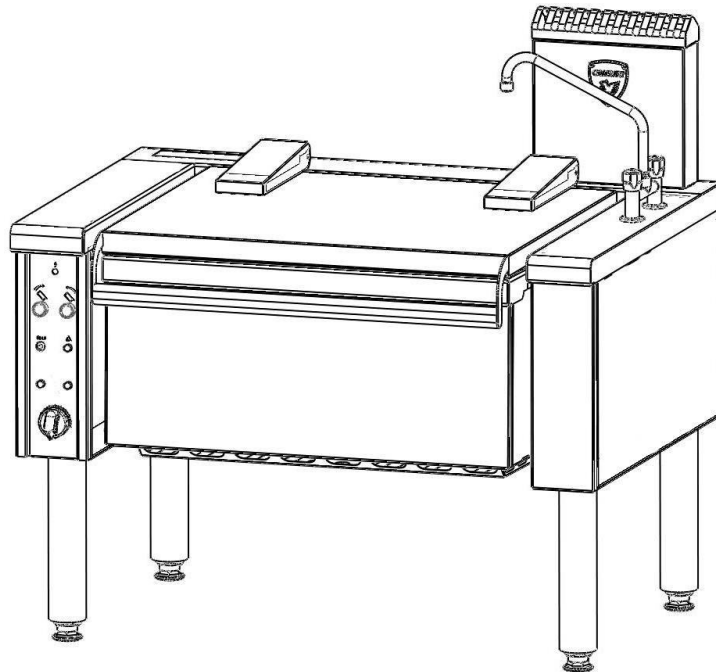
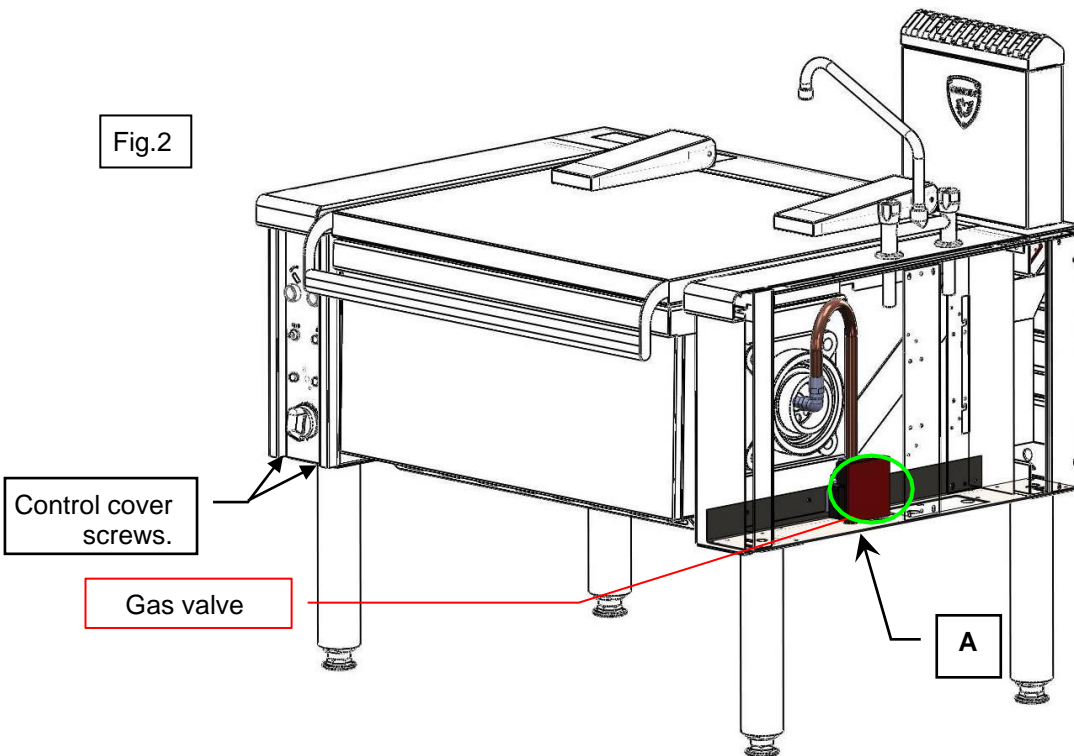

Fig.2



- The gas connection is located beneath the M1/2 tube (Fig.2 A).

2.3. Checks after connection

- The tightness of the circuit up to the tap.
- Check the gas pressure of the appliance during operation.
- Check flame pattern and colour is correct..
- Adjusting the gas supply pressure (see § 2.4.).
- Check the correct operation of the appliance and the safety components.

2.4. Gas supply pressure check

Note: All appliances connected to the gas pipeline should be in operation for this check.

- Unscrew the control cover (Fig.1 § 2.2.)
 - Slide the control cover down and pull it towards you.
- 1) Turn on the appliance (at max. output).
 - 2) Remove the screw (C) and connect the pressure gauge to the pressure gauge at control output. (1)
 - 3) Check your readings (see tables below).
 - 4) To increase the output:
 - Turn clockwise. (Regulating screw B).
 - 5) Remove the screw (D) and connect the pressure gauge to the pressure gauge outlet at input. (2)
 - 6) Check your readings (see tables below).
 - 7) To increase the output:
 - Turn clockwise. (Regulating screw B).

Rated power	Pressure Regulator input	Pressure Regulator output
20 mbar	18-20 mbar	17-18 mbar
37 mbar	37 mbar	35-37 mbar



The gas valve setting must be changed by a qualified person.
Improper adjustment will result in serious consequences.

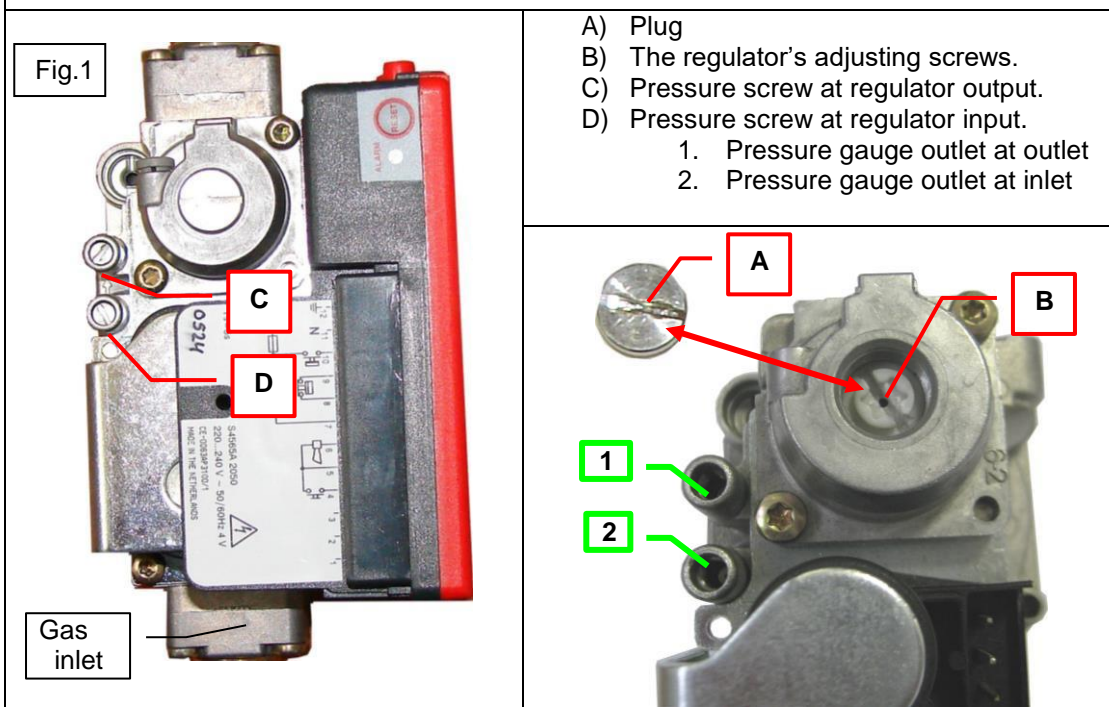

Note: The VK41 gas valve block is to be replaced to switch from the second-family gases, adjustable from 1.5 to 20 mbar, to the third-family gases, adjustable from 37 to 50 mbar.

3. ADAPTING THE APPLIANCE TO DIFFERENT TYPES OF GAS

- In case of gas change at the installation: After changing injectors, check the tightness of the gas circuit at the injector/injector holder connection point.

3.1. Injector changes and air adjustments

Refer to tables (§ 3.2).

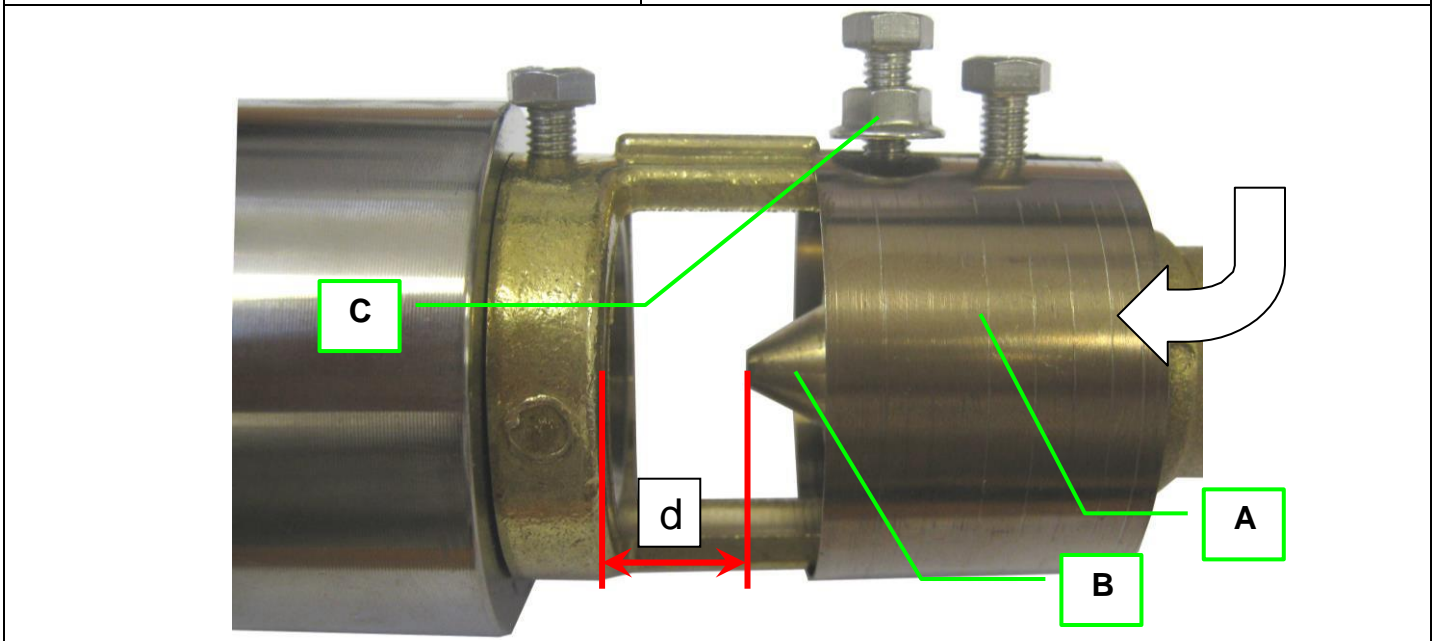
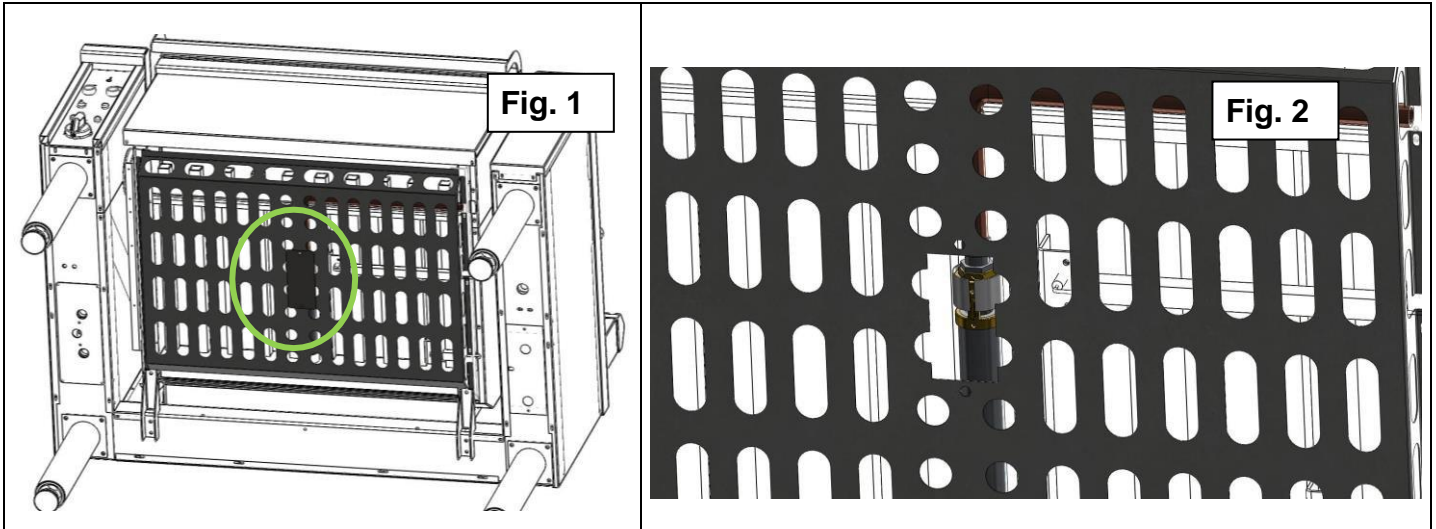

- Remove the injector flap (figs. 1 and 2).
- You now have access to the Venturi.
- The air sleeve (A) and the injector (B) are accessible.
- Loosen the air sleeve (nut (C)/sleeve).
- Change the injector (17 mm ring spanner)
- See Table in § 3.2.
- Set the distance 'd', retighten.
- Tighten the nut and the sleeve after adjustment.
- The arrow = gas input.

3.2. Gas settings table

G1SBEL50					
Setting	Gas type under nominal pressure	Marker engraved on the injector	Air adjustment d (mm) *2	Nominal heat output kW *1	Regulator setting
1	G20: Pn = 20 mbar	3.90	1	25	Screwed in tightly
2	G 25: Pn = 20 mbar	3.90	1		
3	G 25: Pn = 25 mbar	4.50	1		
4	G 30: Pn = 29 mbar	2.70	15	26	Screwed in tightly
5	G 30: Pn = 50 mbar	2.70	Max.	26	29mbar
6	G 31: Pn = 37 mbar	2.70	15	26	Screwed in tightly
7	G 31: Pn = 50 mbar	2.70	Max.	26	37mbar
8	G 110: Pn = 8 mbar				
9	G 120: Pn = 8 mbar				

- 1 Measured power on lower calorific value of gas (HI) for 1 burner.
- 2 Primary measured air adjustment as shown in Figure 1

G1SBEL75			
Setting	Gas type under nominal pressure	Marker engraved on the injector	Air adjustment d (mm)
1	G20: Pn = 25 mbar	2xØ330	6mm
6	G 31: Pn = 45 mbar	2xØ225	7-8mm

4. ELECTRICAL CONNECTION

Warnings

The appliance must be earthed.
 It is dangerous to put the appliance into service without connecting it to earth.
 Our liability cannot be incurred in the event of accidents resulting from non-existent or incorrect earthing.

Fixed appliance:
 Ensure that the user's fixed installation has an all-pole circuit breaker with point gap in compliance with standard EN 60335-1.

CAUTION:
 Use standard cable (245 IEC 57 or 245 IEC 66) or other cables with the same characteristics.

All the checks and inspections below are carried out when the appliance is switched off and cold.

4.1. Checks before connection

- The electrical voltage of the supply must be compatible with the voltage of the appliance (see § 4.4.).
- Check that the cable is fixed correctly.
- Check that the appliance's connections are tight.
- The cable section of the electrical installation must be compatible with the voltage of the appliance.

4.2. Connecting the appliance to the electricity supply



- Remove the front cover to access the connections box. (See § 3.1. 'Changing the injectors').
- Feed the connection cable into the box (secured with 2 screws).
- Connect the supply cable to the terminals shown in the figure below, according to the instructions on the label on the box.
- Before remounting, check that the electrical insulation of the appliance is in good order (condition of the cables).

4.3. Checks after connection

- Check that the appliance is correctly earthed (see warnings regarding electrical connection),
- The insulation of the electrical equipment,
- Check that the appliance functions correctly (ignition, etc.).

Starting up: refer to the 'Starting up' section of the user manual.

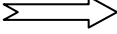
4.4. Table of adaptations to different supply voltages

<i>Transformation voltage</i>					
<i>The various elect. configurations.</i>		1~230V+T	3~230V+T	3~400V+T	3~400V+N+T
G1SBEL50I 75 V02964 ignition control box		A	B	B	B
Wiring diagram		SE0114/00			
G1SBEL50I 75 V02972 the control part		A	B	B	B
Wiring diagram		SE0115/00			

5. WATER CONNECTION(V02972)

Solenoid valve

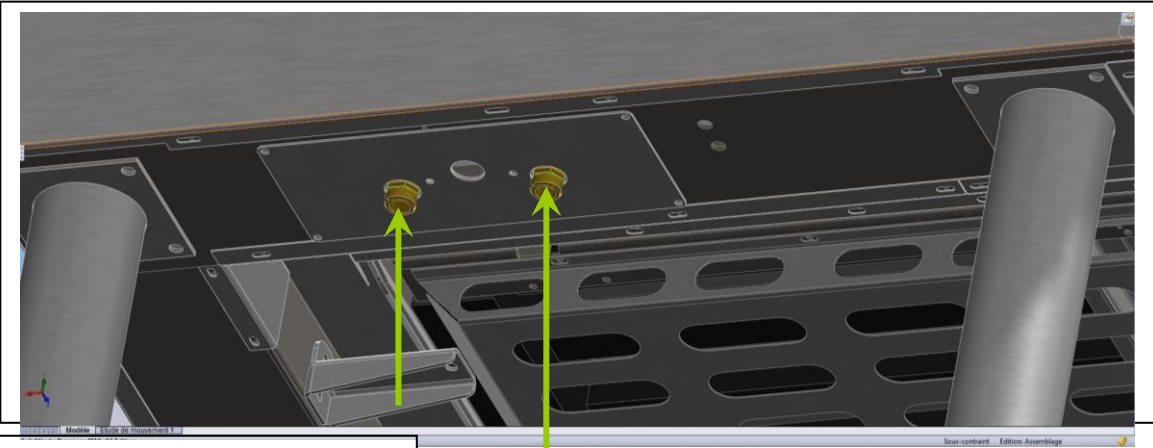
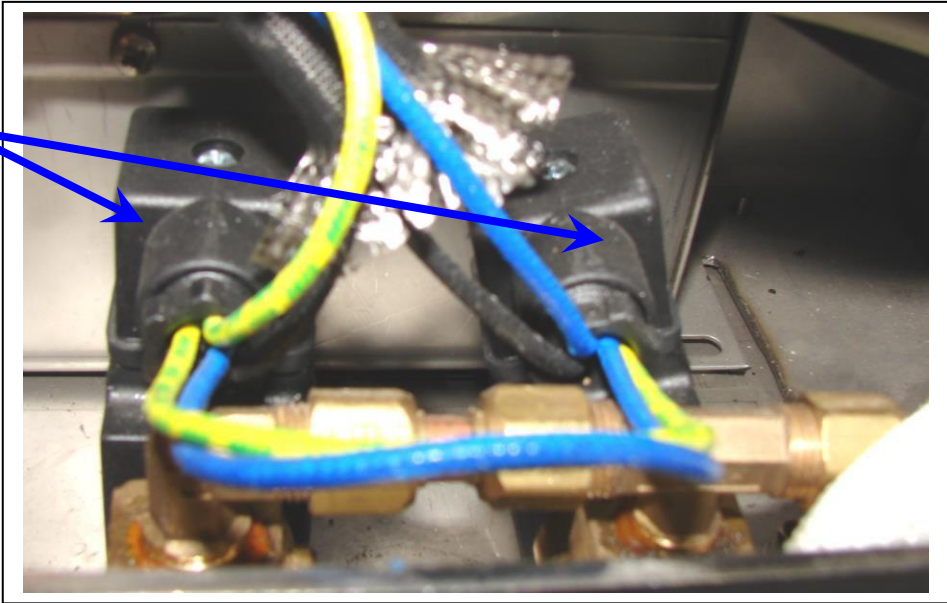

Hot water connection.

Cold water connection.

5.1. Removing the solenoid valve

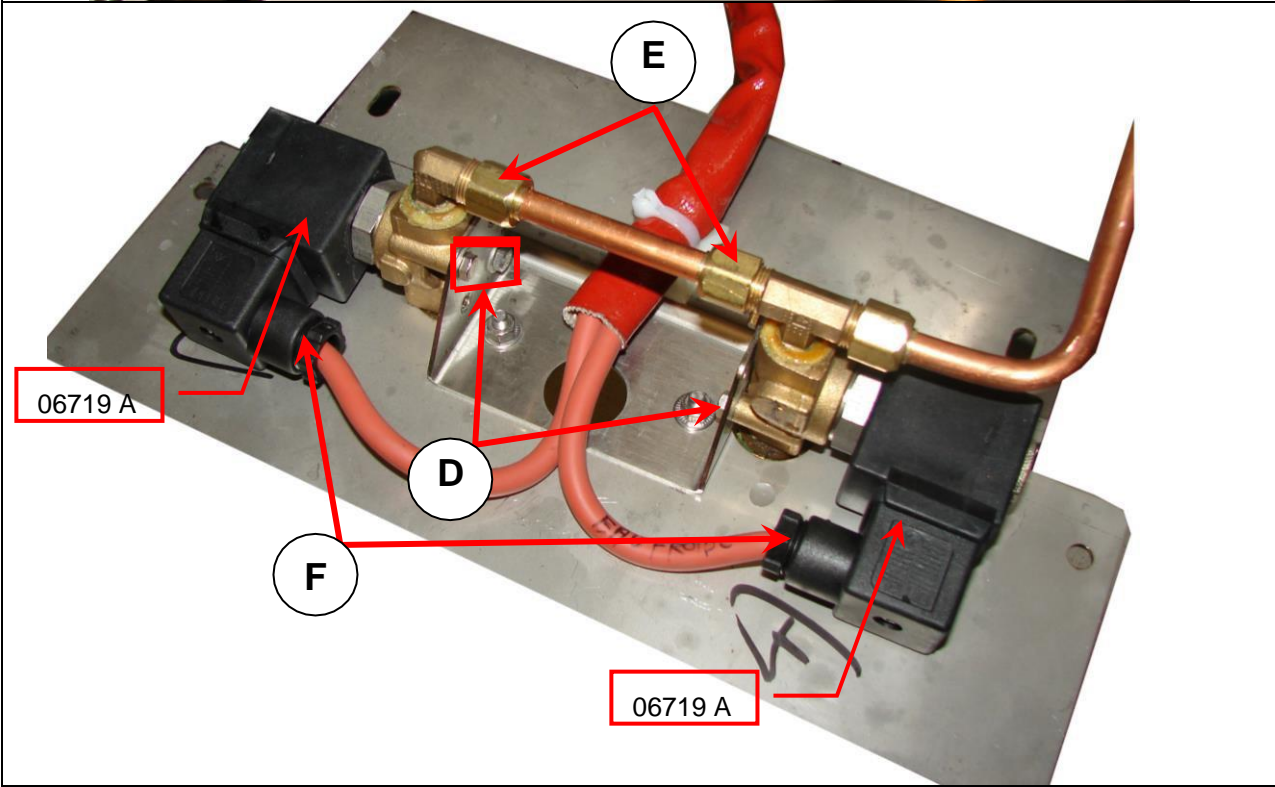
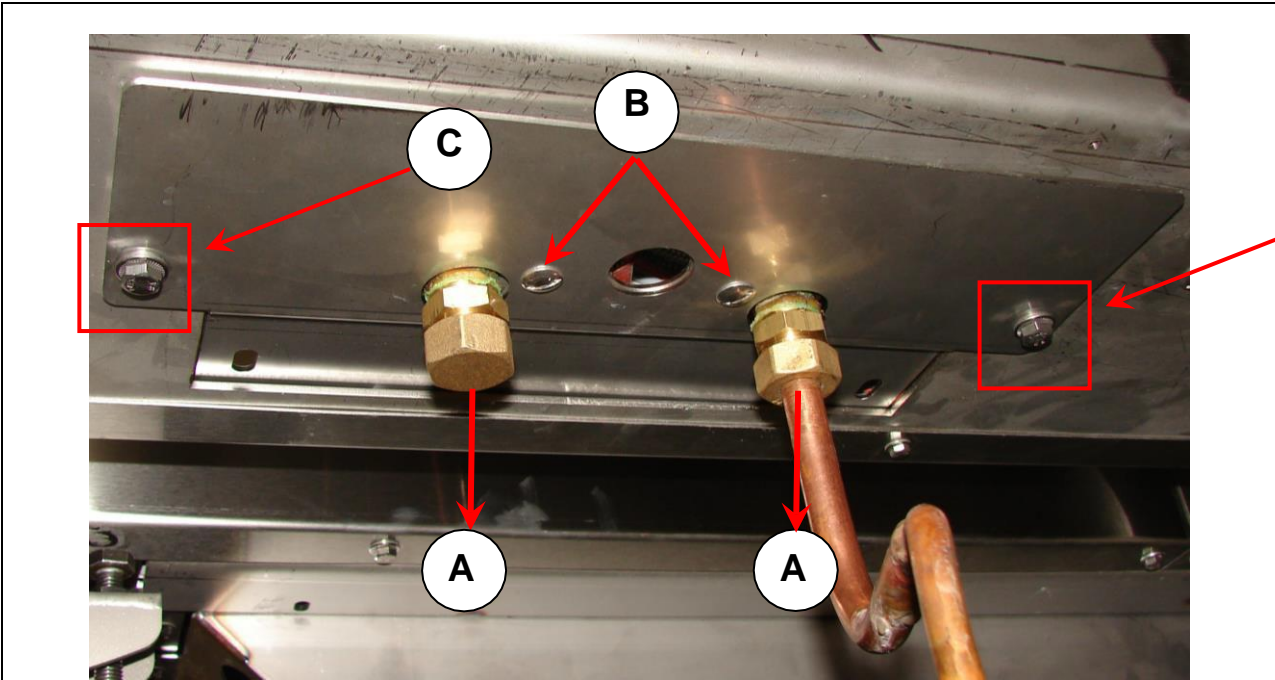











- a) Remove the water inlets.
- b) Unscrew the small bracket. (2 screws).
- c) Unscrew the large bracket. (2 screws).
- d) Unscrew the solenoid valve's retaining screws. (4 screws).
- e) Unscrew the copper connection.
- f) Disconnect the solenoid valves.









5.2. Checks and inspections after water connection.

- After connecting check:
- The watertightness of the water circuit.
- The proper functioning of the water circuit.

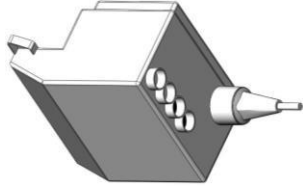
6. LIST OF EMERGENCY PARTS

Description	Code	Photo	Description	Code	Photo
75 Aero injector Ø Natural Ø Propane	(x2)00217A (x2)09179A		Reset push button for Electronic box	ELE0018	
Option: Pan tilting electronic control circuit.	08793 A		Option: water solenoid valve	06719 A	
Option: Pulse control electronic circuit	08794 A		Ignition spark plug	172072	
Option: Digital display thermostat	08795 A	 	Red light 230V Green light 23V White light 23V Amber light 230V	173639 173642 173641 173640	
Gas valve	506222	 	Temperature probe	08783 A	
Option: Water meter	08796 A		Pulse transmitter	09103 A	

Tilting bratt pan 50-75

Description	Code	Photo	Description	Code	Photo
Lifting and lowering switch	07890 A		Right-hand lever pan limit switch sensor	506116	
Electric tilting jack	08785 A		Control box	08786 A	
230V energy meter	09099 A		Jack cable	08787 A	
Burner 75dm2 Aero	168401		Burner 50dm2 Aero	103936	
360° mixed water tap	506388				
180° mixed water tap	506389				

7. Wiring G1SBE 50/75 dm²

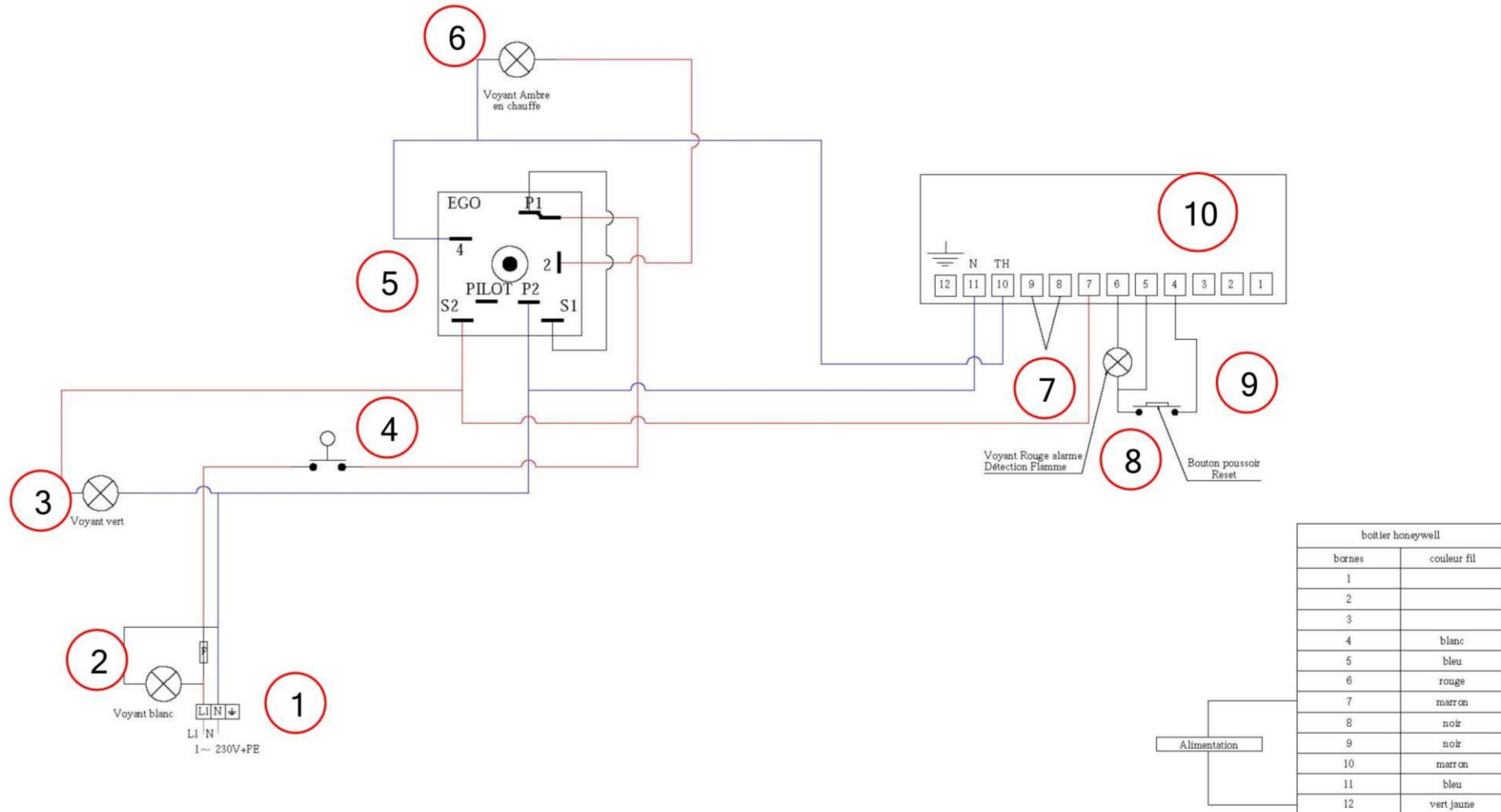

Item	Code	Description	Qty	Item	Code	Description	Qty
01	02468 A	Viking terminal 10 mm ²	1	06	173640	Amber light	1
01	07069 A	Viking terminal blue	1	07	08783 A	Temperature probe	1
01	03575 A	Viking earth terminal 10 mm ²	1	08	173639	Red light 230V	1
02	173641	White light	1	09	03967 A	Push-button	1
03	173642	Green light	1	10	09124 A	Electronic box	1
04	05092 A	Limit switch	1				
05	09099 A	230V energy meter	1				

8. WIRING DIAGRAMS AND THE VARIOUS OPTIONS:

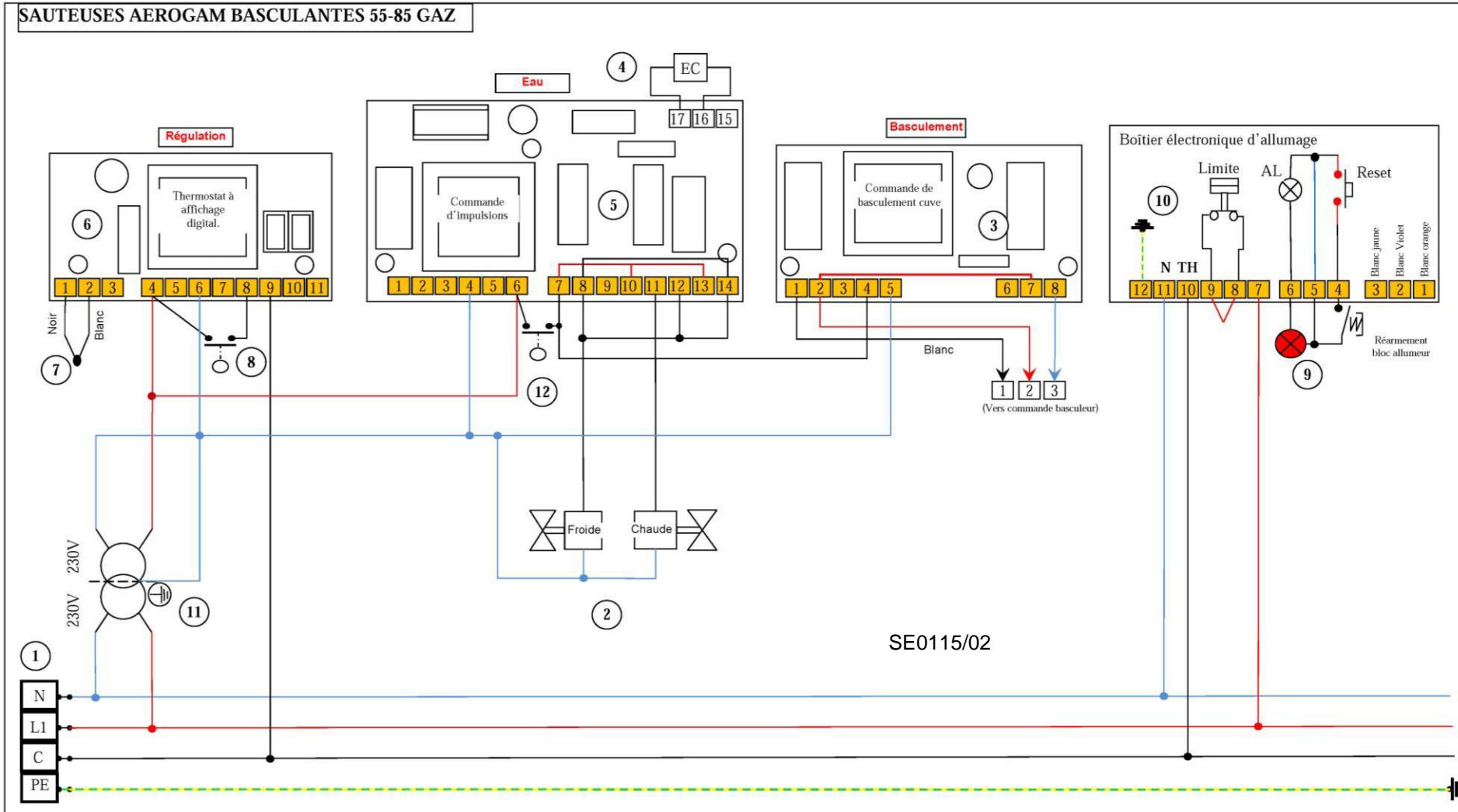

Item	Code	Description	Qty	Item	Code	Description	Qty
01	02468 A	Viking terminal 10 mm ²	3	06	08795 A	Digital display thermostat	1
01	03575 A	Viking Earth terminal 10 mm ²	1	07	08783 A	Temperature probe	1
02	06719 A	Solenoid valve	2	08	05091 A	Pan micro limit switch	1
03	08793 A	Pan tilting control circuit	1	09	173644	Red light	1
04	08796 A	Water meter	1	10	09124 A	Electronic ignition control box	1
04	09103 A	Pulse transmitter	1	11	500723	230V-230V100VA isolation transformer	1
5	08794 A	Pulse control circuit	1	12	05091 A	Lid micro limit switch	1



Gas-powered tilting bratt pans

DESCRIPTION	MODULAR PRO 900
G1SBE 50 AERO	V02964
G1SBE 50 AERO EL	V02972
G1SBE 75 AERO	V03014
G1SBE 75 AERO EL	V03012



User manual

CHARVET

F-38850 – CHARAVINES
Tel.: (33)-4-76-06-64-22
Fax: (33)-4-76-55-78-75
Email: info@charvet.fr
Email: sav@charvet-sa-fr



MANUAL: Pro 900 FR GSBEL50
ind.: A; Date created: 10.09.2010
Updated on:
Manual code:

Page 1

'Compliance with French Decree No. 2005-829 of 20 July 2005.'

Exclusively for France

A - In accordance with Article 18 of Decree No. 2005-829 of 20 July 2005 on the disposal of waste electrical and electronic equipment, the Paul CHARVET company takes responsibility for the financing and organisation of the disposal of its waste. As such, the Paul CHARVET company resumes full ownership of the electrical and electronic equipment at the end of its life.

The equipment should be palletised and ready for loading in a place that is accessible by the carrier. Except in exceptional circumstances, the equipment shall in no case have been dismantled, even partially, otherwise CHARVET reserves the right to re-invoice the costs of processing and taking responsibility for the equipment.

B- How WEEE is disposed of:

The terms and conditions of disposal are covered by the SYNEG/RECYSTEM-PRO agreement, which states that: "In order to fulfil their obligations, the producers of electrical and electronic equipment for large kitchens grouped within the SYNEG, have implemented arrangements for the collection and processing/recycling of WEEE in accordance with the provisions of the decree.

Materials or substances harmful to the environment (such as refrigerants or foams) are extracted or separated. The metal fractions (stainless steel, zinc, copper, etc.) are crushed and transported to refiners for reuse. Therefore, when you need to have electrical equipment collected by a SYNEG professional kitchen equipment manufacturer, you must contact RECYS'TEM-PRO, the operator chosen for the management of WEEE

↳ at this telephone number: 01 45 01 71 43.

↳ or at the following e-mail address: synegdeee@recystempro.com

You will then be sent a collection request sheet which will contain the following elements:

- name of the producer of the equipment
- type of equipment
- estimated weight
- place of collection
- name and contact details of the installer
- invoicing address

After verification with the producer and obtaining its agreement, RECYS'TEM-PRO will proceed with the collection."

"This device complies with the 2009/142 (Declaration of conformity to type) directive"



Contents

<u>USER MANUAL</u>	1
1. <u>STARTING UP FOR THE FIRST TIME</u>	4
1.1. CONTROL COVER	5
2. <u>STARTING UP</u>	6
2.1. STARTING UP THE WATER PART	6
2.2. PROCEDURE FOR MANUALLY FILLING WITH WATER	6
2.3. PROCEDURE FOR FILLING WITH WATER BY PROGRAMMING	6
2.4. STARTING UP THE HEATING PART.....	6
2.5. TILT CONTROL PART	6
2.6. PROCEDURE FOR TILTING THE PAN.....	6
3. <u>SWITCHING OFF</u>	7
4. <u>MAINTENANCE</u>	7
4.1. CLEANING THE STAINLESS STEEL SURFACES.....	7
5. <u>TABLE OF POSSIBLE PROBLEMS</u>	8
<u>PROBLEM</u>	
PROBABLE CAUSES	8

INTRODUCTION:

- A) Our appliances are intended for professional use and should be used by qualified personnel.
- B) They must be installed in accordance with the regulations and standards in force in the country of installation, in a sufficiently ventilated room with an extractor hood.
- C) The appliance may be attached to others or placed against fire-proof walls, but must not, under any circumstances, be located within 10 cm of any combustible element.
- D) Any modifications to existing equipment or any new installations must be carried out by a qualified installer.
- E) **WARRANTY:** *The warranty is part of the sale contract. For any work to be carried out under the warranty, please contact an authorised dealer. This warranty does not cover any damages due to faulty installation, misuse or inadequate maintenance.*

Warnings:

The Pro 900 G1SBEL50 bratt pan should not be used as a fryer.
Any abnormal use of the appliance could have consequences on its operation or on the safety of property and persons.
We cannot be held liable.
Prolonged use of the pan when empty and without supervision may damage the appliance.
Remove any objects from the pan.



The FIRST FEW TIMES YOU START UP the appliance: The GAS valve may go into 'ERROR'. Please
RESET by pressing Reset.
CAUTION: ALL 'ERRORS' must be analysed before resetting

1. STARTING UP FOR THE FIRST TIME:

- a) Prior to starting up for the first time, it is advisable to clean the appliance in order to eliminate all dust or impurities that have accumulated during storage. (see Starting up in § 2)
- b) Remove all protective plastic wrapping from the stainless steel parts.
- c) Make sure that all the control components are functional, then open the gas block valve.
- d) Clean the pan before filling it. To do this:
 - Fill the pan with slightly soapy water just above the maximum level indicated on the pan.
 - The nominal level is 100 litres (GSBEL50) 150 litres (GSBEL75).
 - Boil the water, keep it boiling for a few minutes.
 - Turn off the burner and drain after cooling. When the sides of the pan have cooled down, clean by wiping with a non-abrasive sponge soaked with detergent.
 - Rinse thoroughly and dry the pan.
- e) Make sure that the pan is dry before filling it.

1.1. Control cover

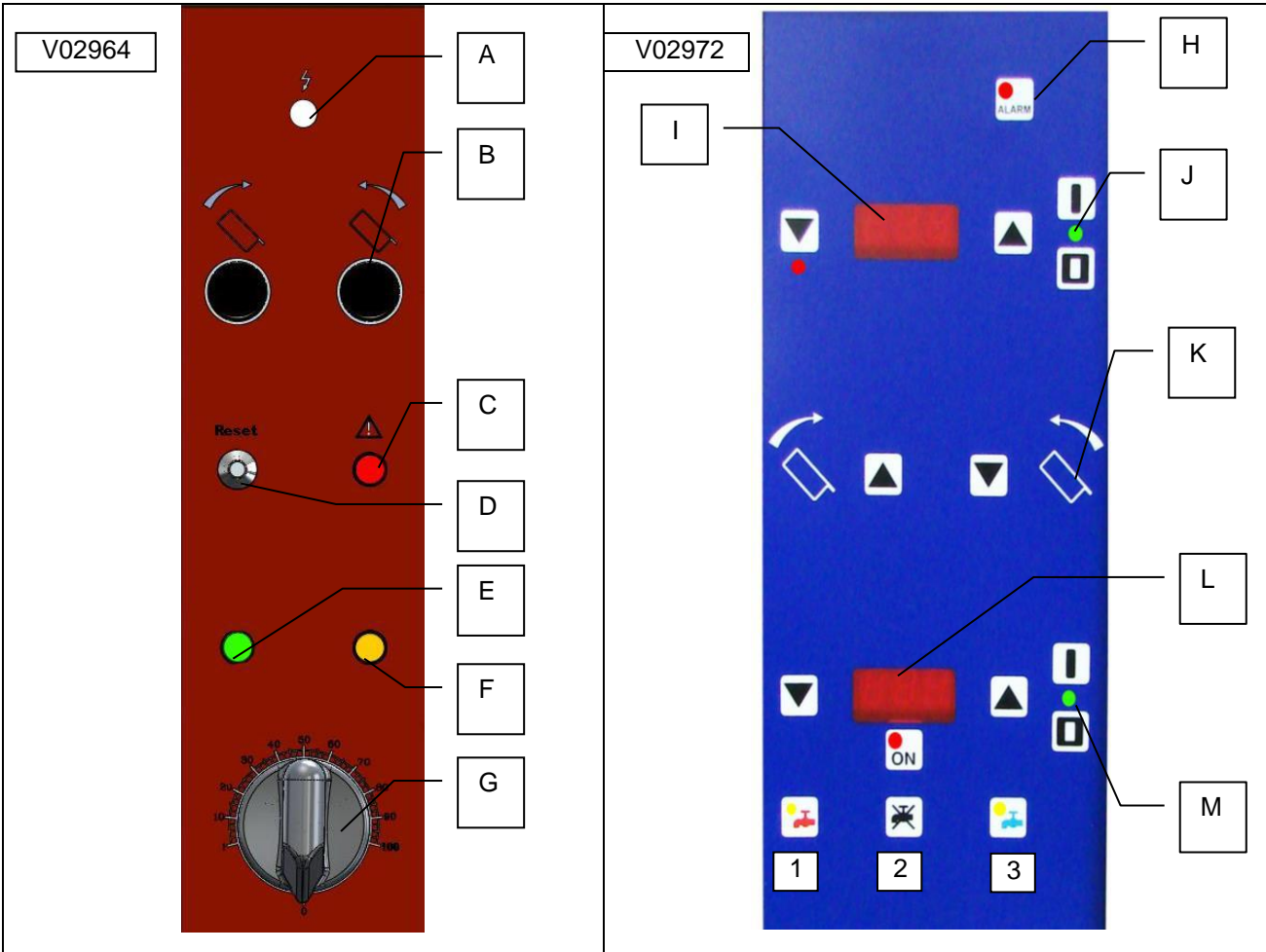

G1SBE V02964/V03014

A	Power indicator
B	Tilt control button
C	'Alarm', the red indicator light comes on. The gas valve is shut off. Analyse the alert before resetting.
D	Reset button. The gas valve is shut off.
E	Green light: 'Burner ignition'
F	Amber light: 'Burner in operation'
G	Energy meter

G1SB-EL V2972/V03012

H	'Alarm', the red indicator light comes on. The gas valve is shut off. Analyse the alarm before resetting.
I	Digital temperature display/ (red heating-up light).
J	Start/Stop (Green power-on light).
K	Tilt control
L	Digital water volume display / ON = water volume programming is on.
M	Start/Stop (Green light indicates power, water control and programming are on).
1	Hot water.
2	Water cut off.
3	Cold water.

2. STARTING UP:

General: The burner is equipped with an ignition spark plug. There is a temperature sensor beneath the pan.

G1SBE50/75 EL (V02972, V03012)

2.1. Starting up the water part:

Before using, fill the pan with water: (Nominal capacity is 100 litres).

2.2. Procedure for manually filling with water:

- a) Press on cold water (3), the amber light comes on to indicate that the appliance is in operation. (See control cover).
- b) Keep the button pressed down and once the desired volume of water has been reached, release the button.

2.3. Procedure for filling with water by programming (V02972, V03012):

- a) Press Start (M), the green light comes on to indicate that the appliance is powered on.
- b) Select the volume of water using: **+** or **-** (see control cover).
- c) The selected volume is displayed on the digital display.
- d) Then, press ON (L), the red light comes on. This indicates that the programming is on.

2.4. Starting up the heating part:

G1SBE50/75 EL (V02972, V03012)

After filling the pan with water. Turn on the bratt pan.

Press the Start button (J), the green light comes on to indicate that it is powered on.

G1SBE50/75 (V02964, V03014)

After filling the pan with water. Turn on the bratt pan.

Turn the control knob (G), the green light comes on to indicate that it is powered on. When the amber light comes on, the burner is in operation.

Note: If the alarm light comes on the 1st time you start up the appliance, see the reset procedure in the warning.

2.5. Tilt control part:

Note: The bratt pan is equipped with a tipping safety device.
This shuts off the burner when it is tilted.

2.6. Procedure for tilting the pan:

- a) With the device switched on,
- b) To tilt the pan: press tilt forwards (K for V02972 and B for V02964) (see control cover).
- c) To lift the pan again: Press Tilt backwards (K for V02972 and B for V02964).



**OUVERTURE TOTALE DU COUVERCLE AVANT
DE BASCULER LA CUVE.**



**FULL OPENING OF THE LID PRIOR TO THE
TILTING THE TANK.**

Charvet cannot be held responsible in the event of misuse of the equipment.

Caution:

When opening the lid during 'wet' cooking, be careful of steam escaping as you pass your arm over the pan because there is a risk of burning.

When emptying:

- **Keep away from the area where cooked products are to be poured, there is a risk of burning due to splashes.**
- **Move with the pan to control pouring in the spout area.**
- **Return the pan to the resting position to avoid any spillage of products when changing the recuperating containers.**

The pan's walls may be very hot after intensive or prolonged use, only manoeuvre the pan using the tipping component.

Warning: This appliance must not be cleaned by means of water spray or water jets under pressure. Check that the appliance is disconnected at the mains.

3. SWITCHING OFF

Turn the control knob (G) to 0 to turn off the appliance. The green light goes out, the appliance is switched off. At the end of the day, shut off the gas valve and the electric power supply. The white power indicator light goes off.

4. MAINTENANCE

Wait until the elements near the burners have cooled down.

4.1. Cleaning the stainless steel surfaces:

- a) Switch off the appliance. After each service and before each cleaning operation, we advise you to disconnect the appliance from the mains (gas and electric supplies).
- b) Wash with a sponge in soapy water (or any other neutral cleaning product). *Do not use bleach or any acid if heavily diluted.*

If necessary, use a scouring sponge for the tops, taking care to always rub **in the direction of polishing**. After each cleaning, rub with an oily rag.

Cleaning the pan

This cleaning can be carried out by soaking, washing with water and a dishwasher cleaning product. When salting foods with coarse salt for dry or semi-wet cooking in the pan, thoroughly rinse the bottom of the pan with plenty of water to remove any remaining salt, thereby avoiding the risk of pitting the stainless steel.

Cleaning the burner

If burner cleaning becomes necessary, contact your installer.

Caution: you must not clean the burner with water.

Table provided as a guide only:

Description	Nominal capacity
<i>Pan 50</i>	100 litres
<i>Pan 75</i>	150 litres

For best results, have your equipment serviced and cleaned regularly, according to the intensity of its use, by a qualified installer.

Caution: Caution: Some parts of this appliance are factory-sealed by the manufacturer. In case of a fault, call a qualified installer.





5. Table of possible problems.

<u>Problem</u>	<u>Probable causes</u>
No heat	Burner outlets, injectors, etc., clogged.
	Gas supply pressure incorrect.
	Incorrectly calibrated injectors.
Faulty ignition	Pan position (see control part)
	Faulty spark plug
	The first 3 times the appliance is started up (see section on resetting),
	Check that there is no moisture on the burner.

Contact the installer to replace any faulty electric control components before further use.

The manufacturer and the installer CANNOT BE HELD LIABLE if the user does not make a request for repairs due to these malfunctions.

Please RECORD the information on the DATA PLATE of your appliance below.

	CHARVET S.A.		
	38850 CHARAVINES		
Réf.	<input style="width: 100%;" type="text"/>		
Code:	<input style="width: 50%;" type="text"/>	Type:	<input style="width: 50%;" type="text"/>
N°FC:	<input style="width: 50%;" type="text"/>		<input style="width: 50%;" type="text"/>
N°OF:	<input style="width: 50%;" type="text"/>	Rep.	<input style="width: 50%;" type="text"/>
Cat.	<input style="width: 50%;" type="text"/>	<input style="width: 50%;" type="text"/>	
Gaz	<input style="width: 50%;" type="text"/>	<input style="width: 50%;" type="text"/>	<input style="width: 50%;" type="text"/>
P (mbar)	<input style="width: 50%;" type="text"/>	<input style="width: 50%;" type="text"/>	<input style="width: 50%;" type="text"/>
ΣQ_n (kW)	<input style="width: 50%;" type="text"/>	<input style="width: 50%;" type="text"/>	<input style="width: 50%;" type="text"/>
ΣV_n (m ³ /h)	<input style="width: 50%;" type="text"/>	<input style="width: 50%;" type="text"/>	<input style="width: 50%;" type="text"/>
ΣM_n (kg/h)	<input style="width: 50%;" type="text"/>	<input style="width: 50%;" type="text"/>	<input style="width: 50%;" type="text"/>
U	<input style="width: 50%;" type="text"/>	V	<input style="width: 50%;" type="text"/>
		Hz Ip	<input style="width: 50%;" type="text"/>
P	<input style="width: 50%;" type="text"/>	kW	<input style="width: 50%;" type="text"/>
	<input style="width: 100%;" type="text"/>		
	MADE IN FRANCE		

This information will facilitate communication with your installer for maintenance and the supply of spare parts.