

# Electric Bratt pan

---

Designation	PRO 800 SERIES		PRO 900 SERIES	
E1SBM33I/50I	V02685	V01700		
E1SBE33I/50I	V02513	V01701		
E1SBM40I/60I			V02687	V02074
E1SBE40I/60I			V02005	V02006

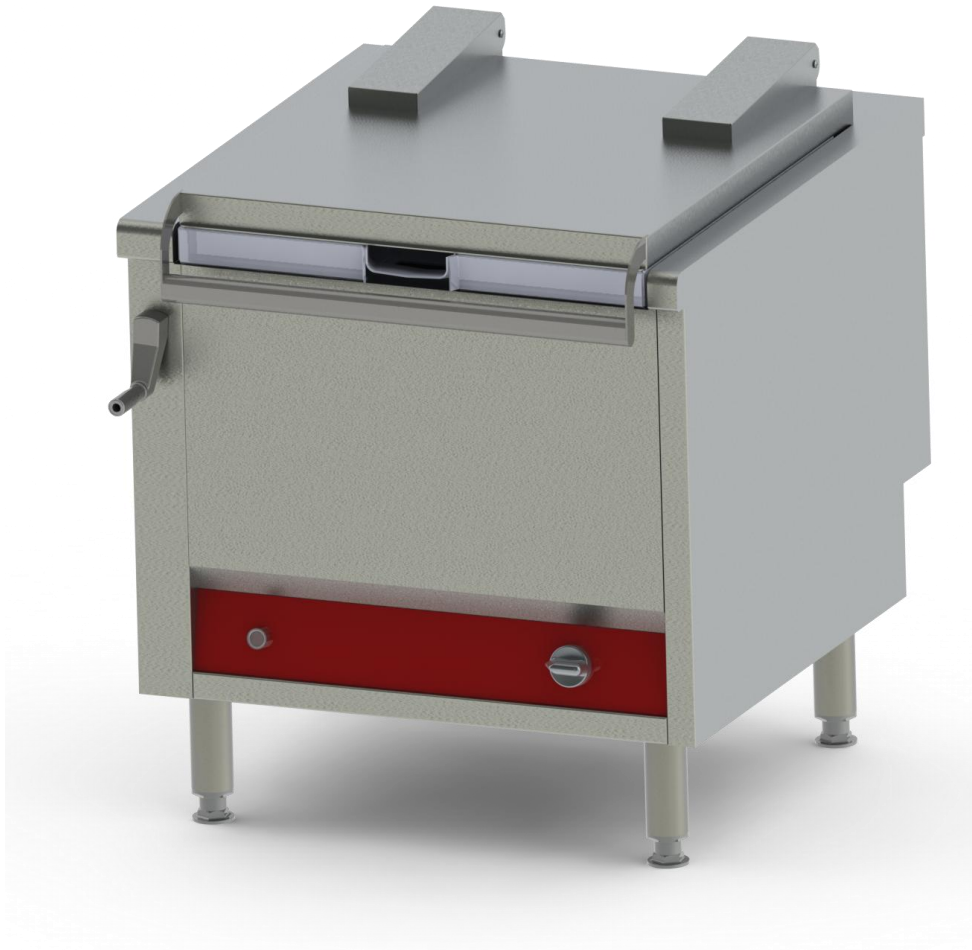

## **INSTALLATION INSTRUCTIONS**

# TABLE OF CONTENTS

<i>INSTALLATION INSTRUCTIONS</i> .....	1
<b>1. INSTALLATION</b> .....	<b>3</b>
1.1. GENERAL POINTS.....	3
1.2. HANDLING - INSTALLATION.....	3
1.3. INSTALLATION.....	3
1.4. DATA PLATE.....	4
<b>2. POWER CONNECTION</b> .....	<b>4</b>
2.1. CHECKS BEFORE CONNECTION .....	4
2.2. CONNECTING THE APPLIANCE TO THE POWER GRID.....	4
2.3. CHECKS AFTER CONNECTION .....	6
2.4. ADAPTING THE APPLIANCE TO THE VARIOUS GRID VOLTAGES .....	6
<b>3. WIRING DIAGRAMS</b> .....	<b>7</b>
<b>4. FIRST AID SPARE PARTS LIST</b> .....	<b>36</b>
<b>5. MAINTENANCE:</b> .....	<b>38</b>
5.1. ADJUSTING THE BALANCED LID (OPTIONAL):.....	38
5.2. CHANGING THE BRATT PAN HEATING ELEMENT. ....	39

## 1. INSTALLATION

### 1.1. General points

The appliance must be installed in an adequately aerated room, equipped with an air extraction system, in compliance with regulations and standards in force in the country of installation, and with the instructions contained in this manual.

**The user's manual must be given to the user after installation.**

### 1.2. Handling - Installation

It is imperative to leave the appliance on its wooden pallet during the handling process until the final installation.

Unpack and check the appliance for damage upon receipt.

In case of damage, detail them immediately on the delivery note; notify the carrier by registered mail with acknowledgement of receipt within 48 hours.

### 1.3. Installation

***Special attention must be paid to the local fire prevention regulations of the organization concerned (see [Public Access Premises]).***

The appliance must be installed under a suitable aspiration hood.

If the appliance is to be installed against a wall or partition, near a piece of furniture or decorative borders, it is recommended that these be of a fireproof material.

If this is not the case, they must be protected by an approved fireproof, insulating material.

If in doubt of fireproof construction of adjacent walls, distance to combustible material shall be no less than 10 cm.

Remove all plastic protection. Install the appliance in the work place.

### Warning

- **Fixed appliance:**

Install the feet or the levelling studs (these are delivered in a separate box).

Level the appliance by adjusting the height of the feet until the working surface is level horizontally.

- **WARNING:**

Independent module units must be fixed to the wall.

- **Mobile appliance:**

Install the castors (these are delivered in a separate box).

The castors with brakes must be locked when the appliance is being connected and at all times during cooking.

**Any intervention or repair on an appliance must be undertaken by a qualified installer.  
The appliance shall be isolated from the electrical supply by stopping the power grid.**

When the appliance is ready for use, ensure the users know how to use it properly.  
(Please see the User's Manual.)

Warranty : The warranty is discussed in our sale contract.

This warranty does not cover damage due to faulty installation, misuse or inadequate maintenance.

# PRO 800-900 Electric Tilting Bratt Pan

## 1.4. Data plate

Each appliance has its own data plate. Transfer all the information written on the data plate to the last page of the user's manual.

**This will facilitate communication between you and your client for better service.**

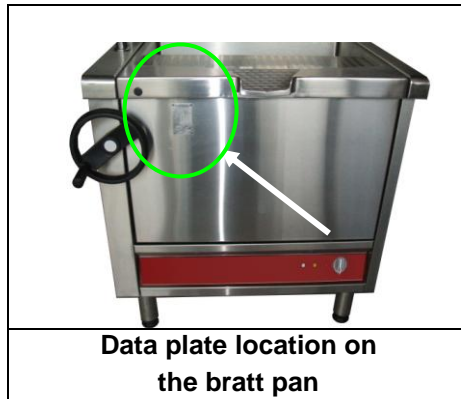

## 2. POWER CONNECTION

### Warnings:

**The appliance must be earth-wired.**  
**It is dangerous to connect the appliance unless it is earthed.**  
**We cannot be held responsible for accidents due to non-existent or incorrect earth link connection.**

### Fixed appliance:

Check that the electrical network is equipped with all-pole circuit breakers with a contact opening distance that is compliant with the European Standard EN 60335-1.

### CAUTION:

Use a standardized cable (245 IEC 57 or 245 IEC 66) or any other approved cable with the same characteristics.

All controls and checks below are done when the appliance is switched off and cold.

### 2.1. Checks before connection

Check that:

- The electrical voltage of the grid is compatible with the voltage of the appliance (see § 4.4).
- The cable is fixed properly,
- The connections are tight enough,
- The cross-section of the electrical cable is compatible with the power of the appliance.

### 2.2. Connecting the appliance to the power grid

Unscrew the front panel to access the junction box.

Place the cable into the junction box (fixed with 2 screws).

Connect the power cable to the terminals, following the information written on the box (see figures below).

Before reassembling the parts, check that the electrical equipment is properly insulated (condition of the cables).

## PRO 800-900 Electric Tilting Bratt Pan

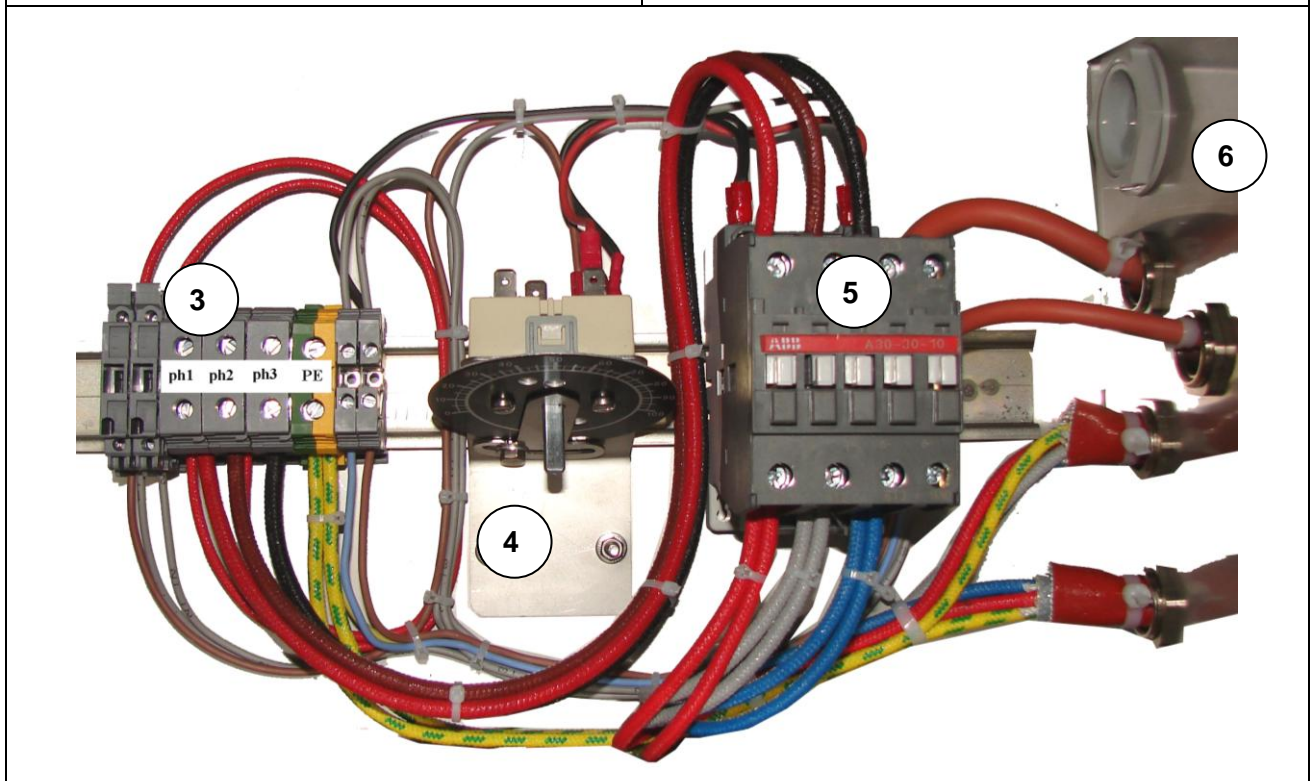
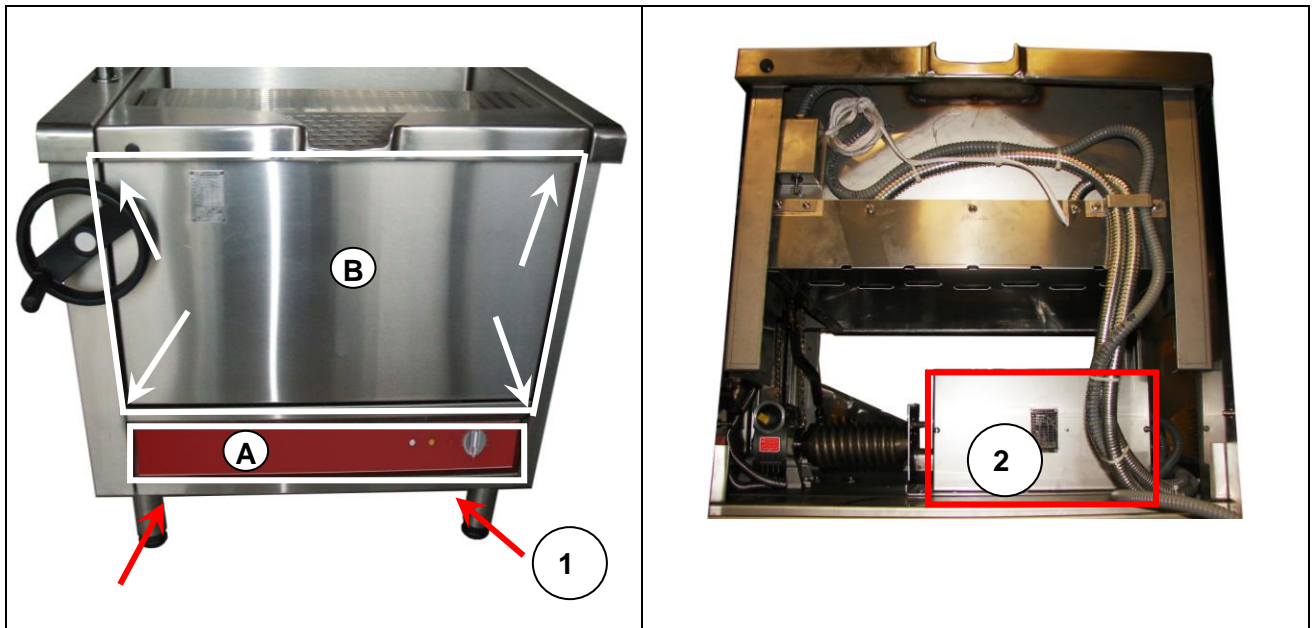

1. (A) Remove the control panel (fixed with 2 screws)  
(B) Remove the front panel (fixed with 4 screws)

2. Electrical box.
3. Grid-connected terminal block
4. Optional: (Energy regulator)
5. Contactor
6. Input power to the grid.



## PRO 800-900 Electric Tilting Bratt Pan

### 2.3. Checks after connection

- The appliance is earth-wired,
- The equipment is well insulated;
- The appliance is in good working condition (ignition, etc.),

STARTING UP: Please see the user's manual, "Starting up" section

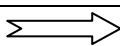
### 2.4. Adapting the appliance to the various grid voltages

Transformer voltage		1~230V + E	3~230V + E	3~400V + E
Electrical supply configurations 				
	Wiring diagrams # 	S = standard coupling		
ESB 60L	SE0020/00	S	B	B
ESB safety reset	SE0131/01	C	A	B
ESB energy regulator	SE0127/02	B	B	A
ESB energy regulator safety reset	SE0135/00	B	A	B
ESB 50L	SE0157/00	B	B	A
ESB safety reset	SE0154/00	C	A	B
ESB energy regulator	SE0134/00	B	B	A
ESB 40L	SE0051/01	B	B	A
ESB safety reset	SE0132/00	C	A	B
ESB energy regulator	SE0152/00	B	B	A
ESB 33L	SE0019/01	B	B	A
ESB 33L	SE0017/02	B	A	B
ESB energy regulator	SE0153/00	B	B	A
ESB safety reset	SE0130/01	C	A	B
Three-phase electrical tilting	SE0018/00	B	B	S

A → Coupling possible B → Please consult Charvet C → Coupling impossible D → No voltage available

# PRO 800-900 Electric Tilting Bratt Pan

## 3. WIRING DIAGRAMS

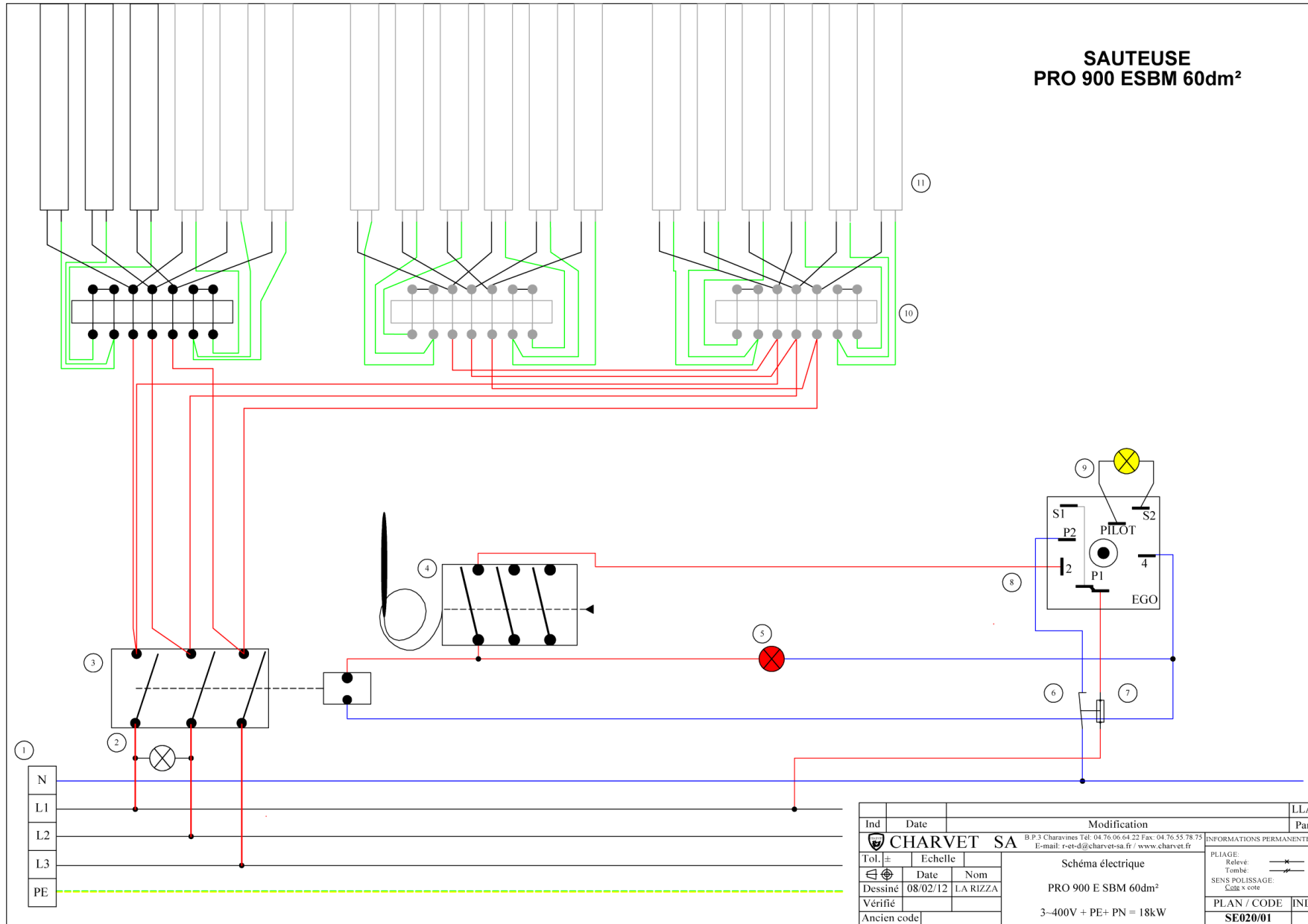

## PRO 800-900 Electric Tilting Bratt Pan

Nomenclature: BRATT PAN E SBM/I 60L 3~ 400V +T SE0020/01

Mark	Code	Designation	Quantity
01	02468A	10 mm <sup>2</sup> Vicking terminal (brand: Viking)	3
01	03575A	10 mm <sup>2</sup> earth terminal (brand: Viking)	1
02	08153A	400V white indicator	1
03	02200A	400V contactor	1
04	01999A	50°C-350°C safety thermostat	2
05	07136A	400V red indicator	1
06	500237	Neutral disconnect terminal block	1
07	02726A	Fuse disconnect terminal block	1
08	09088A	400V energy regulator	1
09	07139A	Yellow indicator	1
10	02465A	7-pole M4 steatite barrier strip + jumper	3
11	505301	1000W-230V heating element	18



# PRO 800-900 Electric Tilting Bratt Pan

**PRO900 ESBME 60dm<sup>2</sup>**  
**sécurité de réarmement**  
**allumage et régulation**  
**+ sécurité de basculement.**

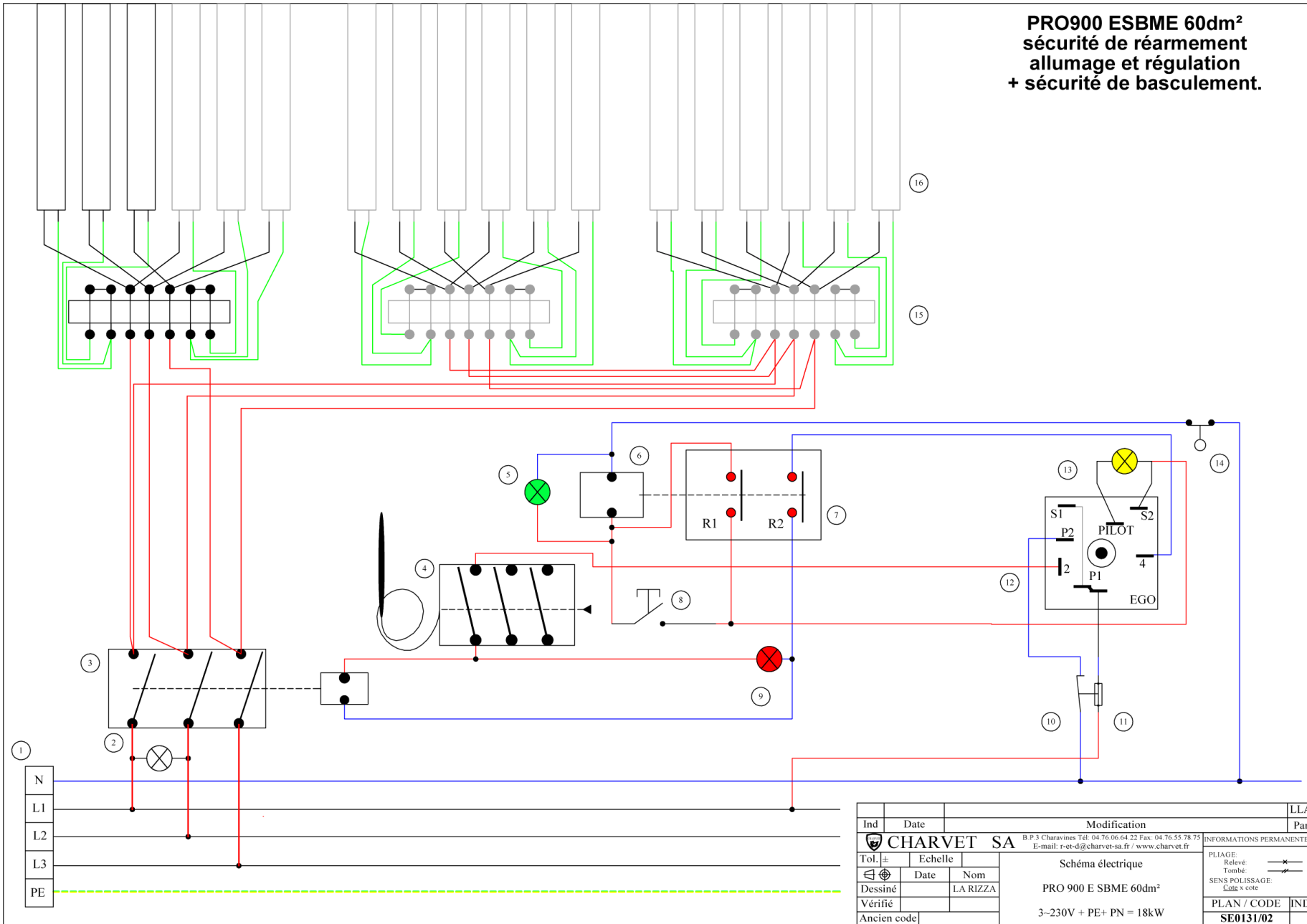

Ind	Date	Modification		LLA
CHARVET SA		B.P. 3 Charvines Tél: 04 76 06 64 22 Fax: 04 76 55 78 75		INFORMATIONS PERMANENTES
E-mail: r-et-d@charvet-sa.fr / www.charvet.fr				
Tol. ±	Echelle	Schéma électrique		PLIAGE: Relève:
Dessiné	Date	PRO 900 E SBME 60dm <sup>2</sup>		Tombe:
Vérifié	LA RIZZA	3-230V + PE+ PN = 18kW		SENS POLISSAGE: Code x cote
Ancien code				PLAN / CODE IND.
				SE0131/02

Ce plan est notre propriété. Il ne peut être copié ni communiqué sans notre autorisation

## PRO 800-900 Electric Tilting Bratt Pan

Nomenclature: Bratt pan ESBM 60L with safety reset (Optional) SE0131/02

Mark	Code	Designation	Quantity
01	02468A	10 mm <sup>2</sup> terminal (brand: Viking)	3
01	03575A	10 mm <sup>2</sup> earth terminal (brand: Viking)	1
02	08153A	White indicator	1
03	00551A	230V contactor	1
04	01999A	50°C-350°C safety thermostat	1
05	08223A	Green indicator	1
06	08243A	220V relay	1
07	08164A	Relay base	1
08	ELE0018	Reset push-button	1
09	07137A	230V red indicator	1
10	02726A	Fuse disconnect terminal block	1
11	500237	Neutral disconnect terminal block	1
12	09099A	230V energy regulator	1
13	07140A	230V yellow indicator	1
14	05091A	Limit switch	2
15	02465A	7-pole M4 steatite barrier strip + jumper	1
16	505301	1000W-230V heating element	1

# PRO 800-900 Electric Tilting Bratt Pan

**PRO900 ESBME 60dm<sup>2</sup>  
avec doseur supplémentaire  
pour régulation**

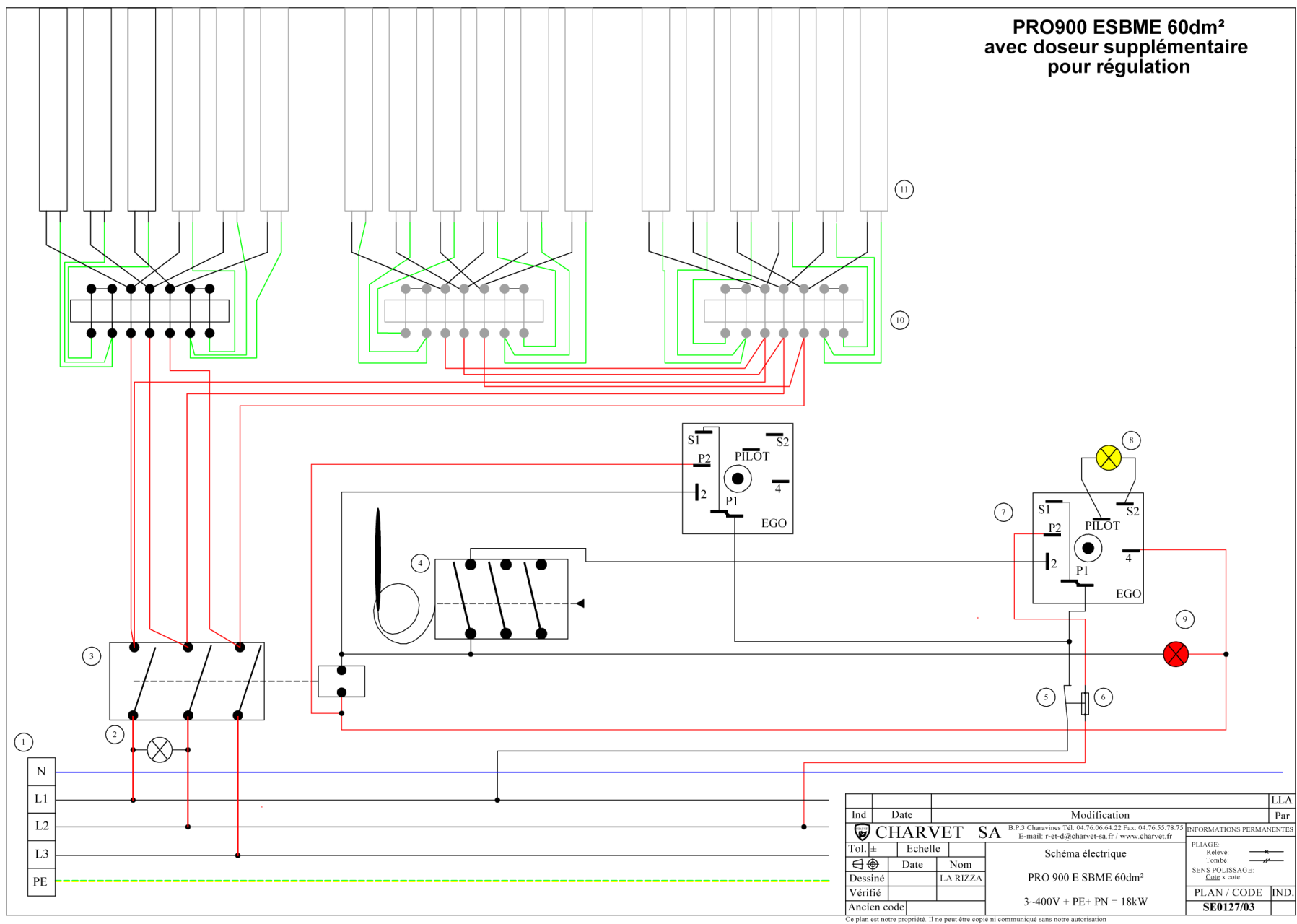

Ind	Date	Modification	LLA
<b>CHARVET SA</b>			Par
<small>B.P. 3 Charvines Tél: 04 76 06 64 22 Fax: 04 76 55 78 75 E-mail: r-et-d@charvet-sa.fr / www.charvet.fr</small>			INFORMATIONS PERMANENTES
Tol. ±	Echelle	Schéma électrique	
Dessiné	Date	PRO 900 E SBME 60dm <sup>2</sup>	
Vérifié	Nom	3-400V + PE+ PN = 18kW	
Ancien code	LA RIZZA	PLAN / CODE IND.	
			<b>SE0127/03</b>

Ce plan est notre propriété. Il ne peut être copié ni communiqué sans notre autorisation

## PRO 800-900 Electric Tilting Bratt Pan

**Nomenclature: Bratt pan ESBME 60dm<sup>2</sup> SE0127/03**

<b>Mark</b>	<b>Code</b>	<b>Designation</b>	<b>Quantity</b>
01	02468A	10 mm <sup>2</sup> terminal (brand: Viking)	3
01	03575A	10 mm <sup>2</sup> earth terminal (brand: Viking)	1
02	08153A	400V white indicator	1
03	02200A	400V contactor	1
04	01999A	50°C- 350°C tripolar safety thermostat	1
05	02726A	Fuse disconnect terminal block	1
06	500237	Neutral disconnect terminal block	1
07	09088A	400V energy regulator	2
08	07139A	400V yellow indicator	1
09	07136A	400V red indicator	1
10	02465A	7-pole M4 steatite barrier strip + jumper	3
11	09031A	1000W-230 V heating element	18

# PRO 800-900 Electric Tilting Bratt Pan

**PRO900 ESBME 60dm<sup>2</sup>  
sécurité de réarmement  
allumage et régulation  
+ sécurité de basculement.**

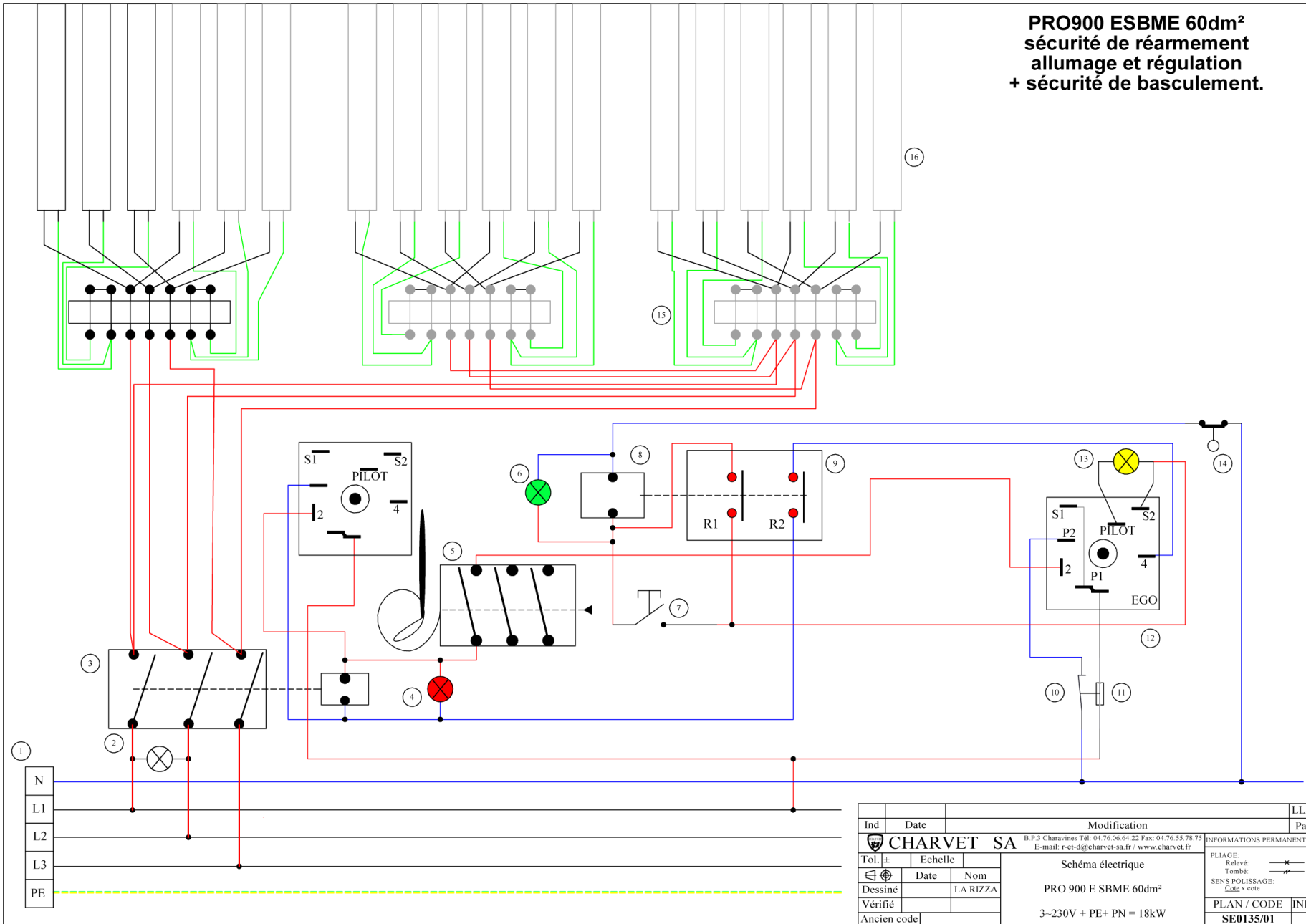

Ind	Date	Modification	LLA
<b>CHARVET SA</b>			Par
<small>B.P.3 Charvines Tél: 04 76 06 64 22 Fax: 04 76 55 78 75 E-mail: r-et-d@charvet-sa.fr / www.charvet.fr</small>			INFORMATIONS PERMANENTES
Tol. ±	Echelle	Schéma électrique	
Dessiné	Date	PRO 900 E SBME 60dm <sup>2</sup>	
Vérifié	Nom	3-230V + PE+ PN = 18kW	
Ancien code	LA RIZZA	PLAN / CODE	IND.
			<b>SE0135/01</b>

Ce plan est notre propriété. Il ne peut être copié ni communiqué sans notre autorisation

## PRO 800-900 Electric Tilting Bratt Pan

### Nomenclature: Bratt pan ESBME 60dm<sup>2</sup> SE0135/01

Mark	Code	Designation	Quantity
01	02468A	10 mm <sup>2</sup> terminal (brand: Viking)	3
01	03575A	10 mm <sup>2</sup> earth terminal (brand: Viking)	1
02	00551A	230V contactor	1
03	09031A	1000W-240V heating element	18
04	03413A	Ø 5 mm x 20 mm - 5 A fuse	1
04	02726A	Fuse disconnect terminal block	1
05	07137A	Red indicator	1
06	07140A	Yellow indicator	1
07	09099A	230V energy regulator	2
08	01999A	50°C-350°C safety thermostat	1
09	05091A	Limit switch	1
10	08243A	220V relay	1
11	ELE0018	Reset push-button	1
12	07140A	Green indicator	1
13	08164A	Relay base	2
14	500237	Neutral disconnect terminal block	1
15	08153A	White indicator	1

# PRO 800-900 Electric Tilting Bratt Pan

**SAUTEUSE  
PRO800 ESBM 50dm<sup>2</sup>**

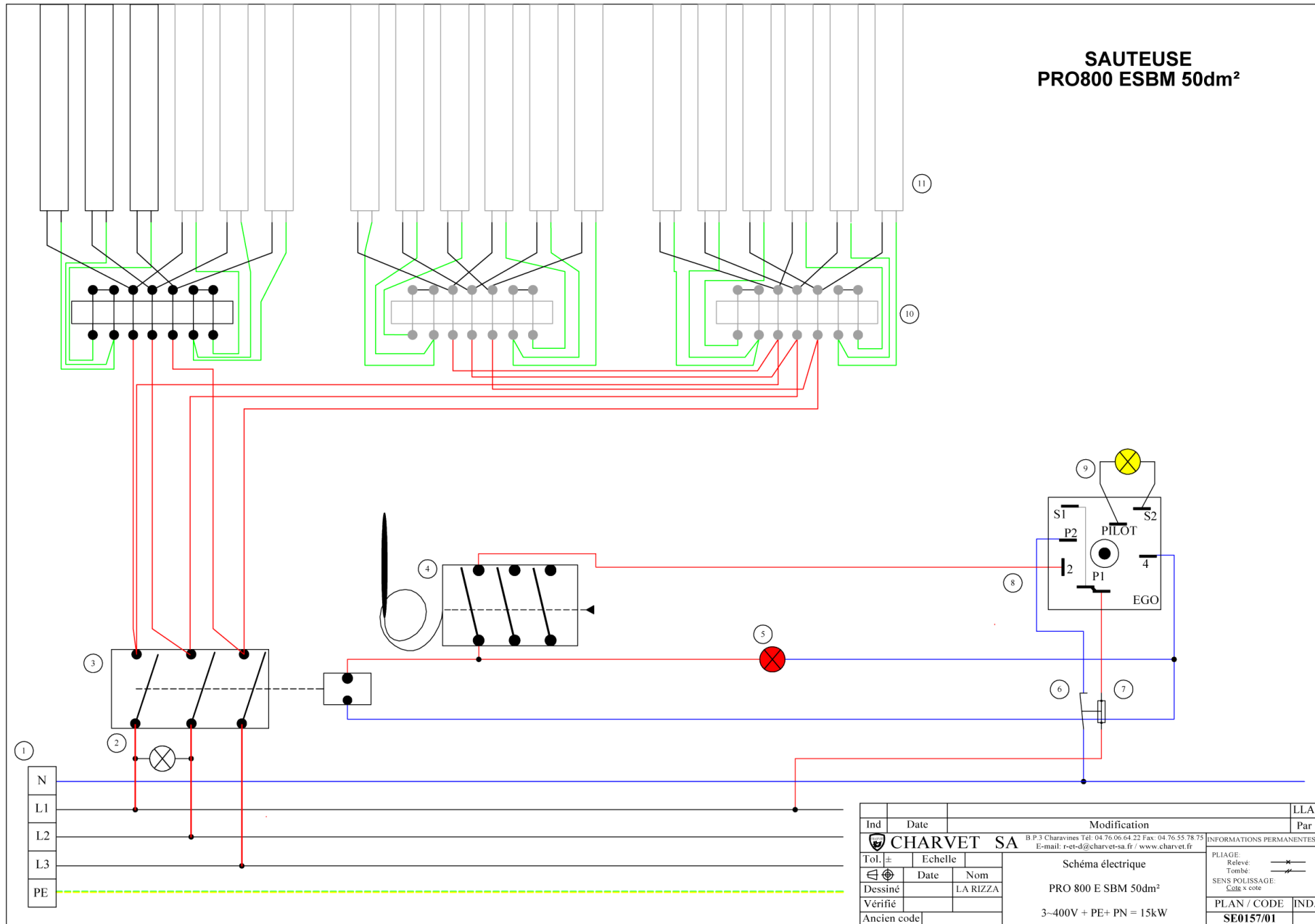

Ind	Date	Modification	LLA
			Par
<b>CHARVET SA</b>			B.P. 3 Charvines Tel: 04 76 06 64 22 Fax: 04 76 55 78 75 E-mail: r-et-d@charvet-sa.fr / www.charvet.fr
Schéma électrique PRO 800 E SBM 50dm <sup>2</sup> 3~400V + PE+ PN = 15kW			INFORMATIONS PERMANENTES PLIAGE: Releve: Tombe: SENS POLISSAGE: Code x cote
Tol. ±	Echelle		PLAN / CODE IND.
Dessiné	Date	Nom	
Vérifié			
Ancien code			
			<b>SE0157/01</b>

Ce plan est notre propriété. Il ne peut être copié ni communiqué sans notre autorisation

## PRO 800-900 Electric Tilting Bratt Pan

Nomenclature: Bratt pan ESBM 50 L Pro 800 3~400V + T (SE0157/01)

Mark	Code	Designation	800
01	02468A	Viking terminal	3
01	03575A	Viking terminal	1
02	02200A	400V contactor	1
03	09033A	850W-240V heating element	18
04	02726A	Fuse disconnect terminal block	1
05	07136A	230 V red indicator	1
06	07139A	230V yellow indicator	1
07	09099A	230V energy regulator	1
08	01999A	50°C-350°C tripolar thermostat	1
09	08153A	White indicator	1
10	500237	Neutral disconnect terminal block	1



# PRO 800-900 Electric Tilting Bratt Pan

**PRO800 ESBM 50dm<sup>2</sup>  
avec doseur supplémentaire  
pour régulation**

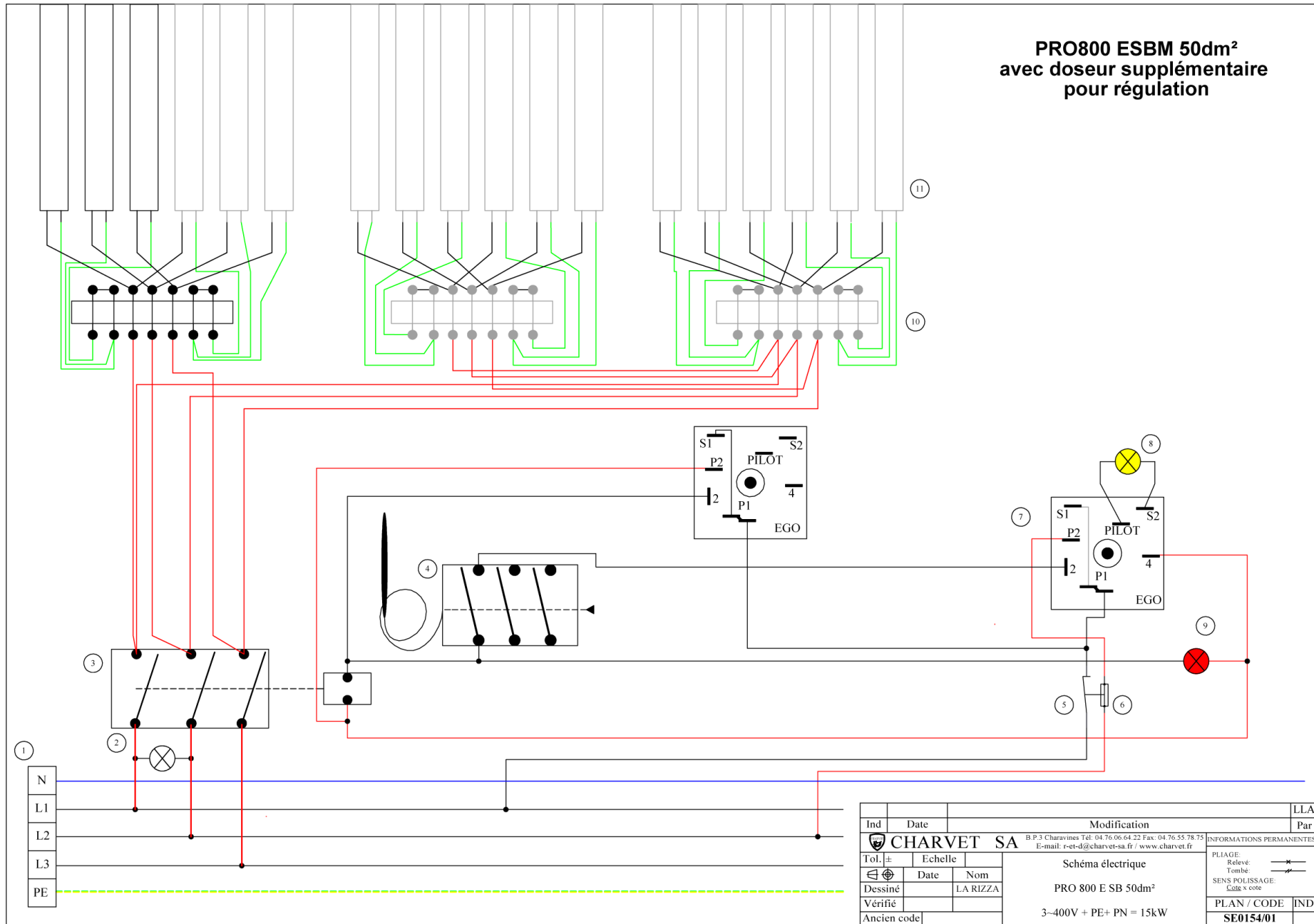

Ind	Date	Modification	LLA
<b>CHARVET SA</b> B.P.3 Charvines Tél: 04.76.06.64.22 Fax: 04.76.55.78.75 E-mail: r-et-d@charvet-sa.fr / www.charvet.fr			INFORMATIONS PERMANENTES
Tol. ±	Echelle	Schéma électrique	
Dessiné	Date	PRO 800 E SB 50dm <sup>2</sup>	
Vérifié	Nom	3-400V + PE+ PN = 15kW	
Ancien code	LA RIZZA	PLAN / CODE IND.	
			<b>SE0154/01</b>

Ce plan est notre propriété. Il ne peut être copié ni communiqué sans notre autorisation

## PRO 800-900 Electric Tilting Bratt Pan

### Nomenclature: Bratt pan ESB 50L Pro 800 (SE0154/00)

Mark	Code	Designation	Quantity
01	02468A	10 mm <sup>2</sup> terminal (brand: Viking)	3
01	03575A	10 mm <sup>2</sup> earth terminal (brand: Viking)	1
02	02200A	400V contactor	1
03	09033A	850W-240V heating element	18
04	03413A	Ø 5mm x 20mm - 5A fuse	2
04	02726A	Disconnect terminal block	2
05	07136A	Red indicator	1
06/08	09088A	400V energy regulator	1
07	01999A	50°C-350°C tripolar safety thermostat	1
09	07139A	Yellow indicator	1
10	08153A	400V white indicator	1

# PRO 800-900 Electric Tilting Bratt Pan

**PRO800 ESBM 50dm<sup>2</sup>  
sécurité de réarmement  
allumage et régulation  
+ sécurité de basculement.**

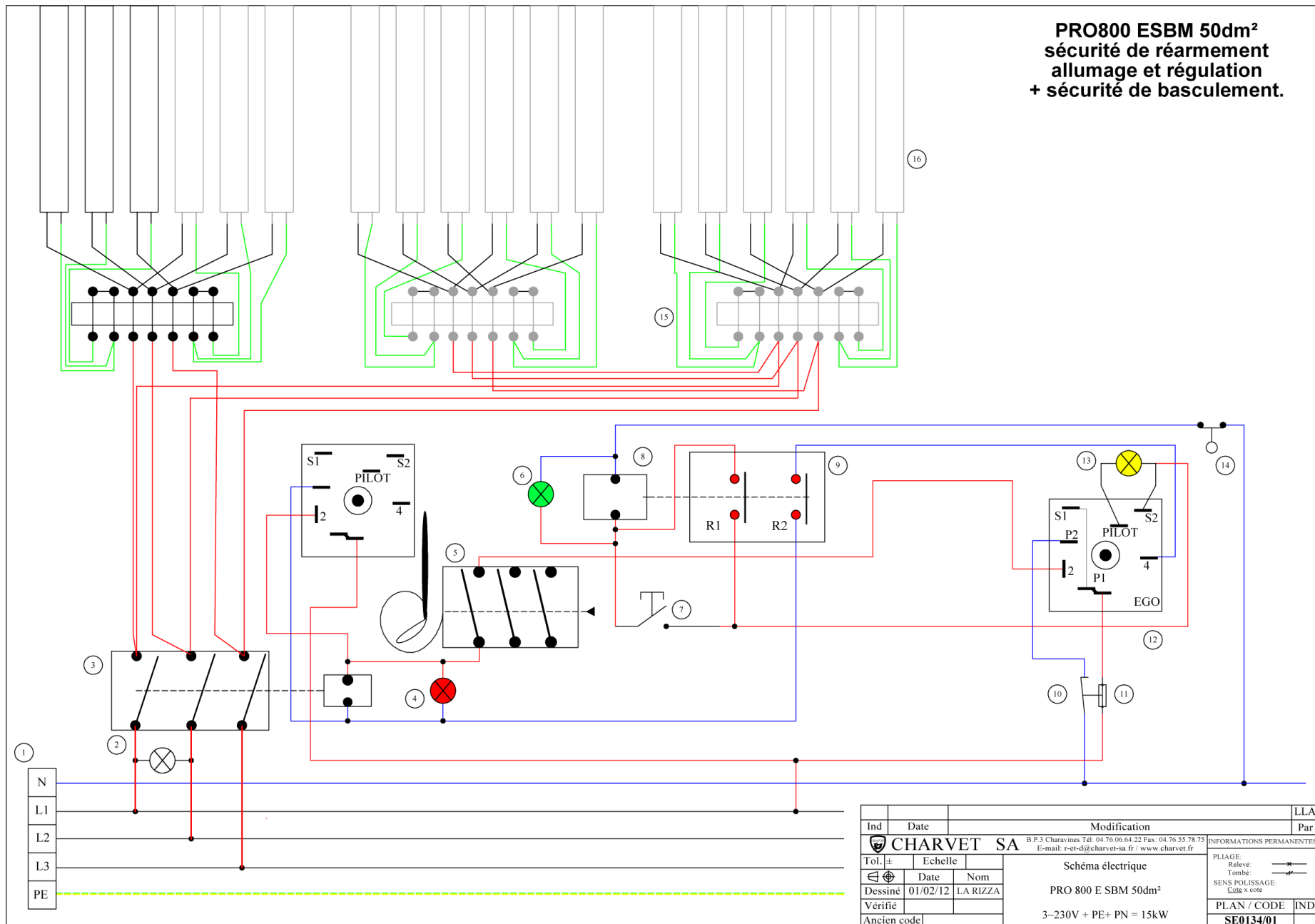

Ind	Date	Modification		LLA
CHARVET SA			B.P.3 Charvines Tél: 04.76.06.64.22 Fax: 04.76.55.78.75	Par
			E-mail: r-et-d@charvet-sa.fr / www.charvet.fr	INFORMATIONS PERMANENTES
Tol. ±	Echelle	Schéma électrique		PLIAGE: Relevé:
Dessiné	Date	PRO 800 E SBM 50dm <sup>2</sup>		Tombé:
Vérifié	Nom	3-230V + PE+ PN = 15kW		SENS POLISSAGE: Côté x cote
Ancien code		SE0134/01		PLAN / CODE IND.

Ce plan est notre propriété. Il ne peut être copié ni communiqué sans notre autorisation.

## PRO 800-900 Electric Tilting Bratt Pan

Nomenclature: Bratt pan ESBM 50L with safety reset (Optional) SE0134/01

Mark	Code	Designation	Quantity
01	02468A	10 mm <sup>2</sup> terminal (brand: Viking)	3
01	03575A	10 mm <sup>2</sup> earth terminal (brand: Viking)	1
02	00551A	230 V contactor	1
03	09033A	850W-240V heating element	18
04	03413A	Ø 5 mm x 20 mm - 5 A fuse	1
04	02726A	Fuse disconnect terminal block	1
05	07137A	Red indicator	1
06	07140A	Yellow indicator	1
07	09099A	230V energy regulator	1
08	01999A	350°C safety thermostat	1
09	05091A	Limit switch	1
10	08243A	220V relay	1
11	ELE0018	Reset push-button	1
12	08223A	Green indicator	1
13	08164A	Relay base	2
14	500237	Neutral disconnect terminal block	1
15	08153A	White indicator	1

# PRO 800-900 Electric Tilting Bratt Pan

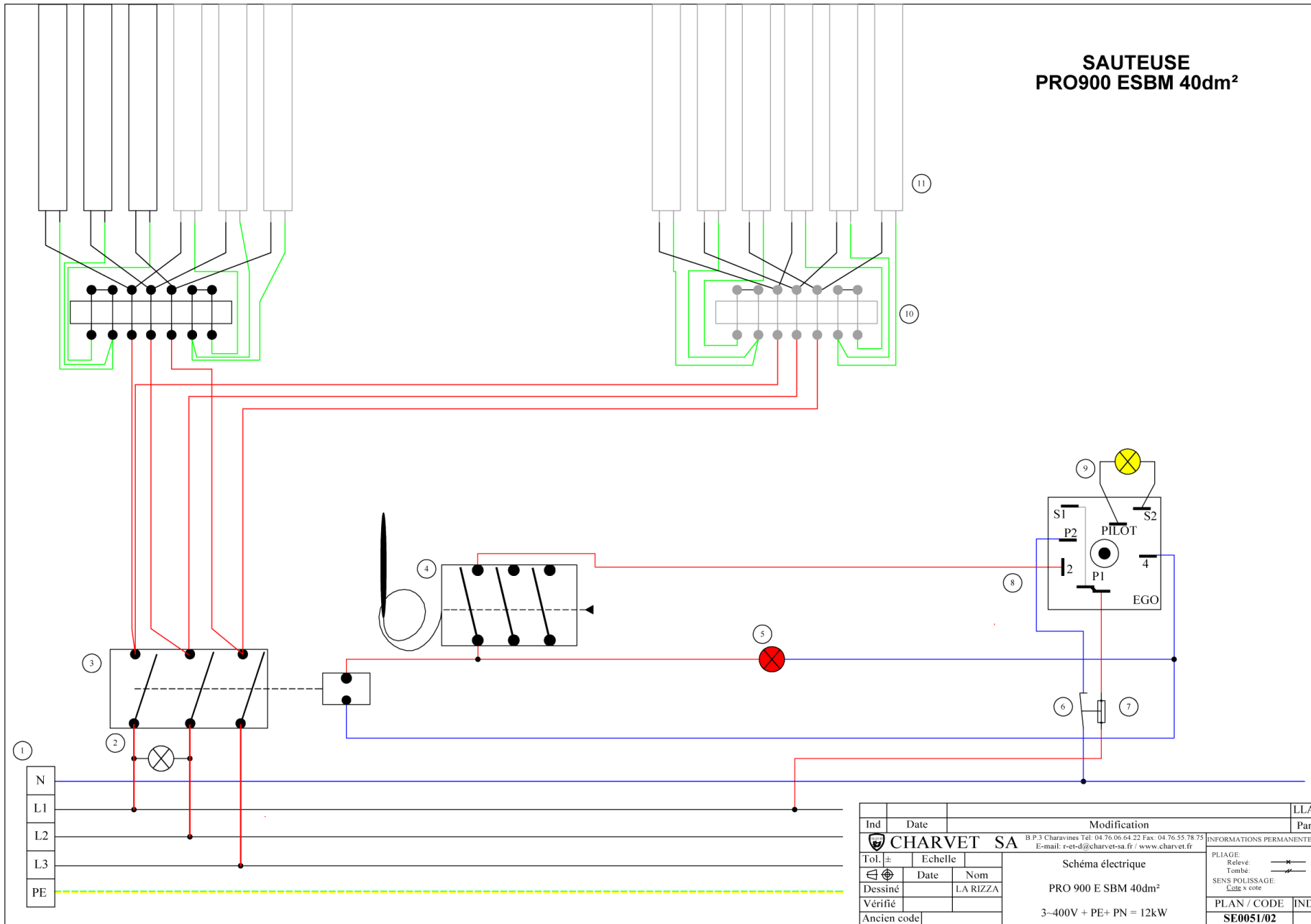

Ind	Date	Modification	LLA
			Par
<b>CHARVET SA</b> <small>B.P.3 Charavines Tel: 04 76 06 64 22 Fax: 04 76 55 78 75          E-mail: r-et-d@charvet-sa.fr / www.charvet.fr</small>			INFORMATIONS PERMANENTES
Tol. ±	Echelle	Schéma électrique	
Dessiné	Date	PRO 900 E SBM 40dm <sup>2</sup>	
Vérifié	Nom	3~400V + PE+ PN = 12kW	
Ancien code	LA RIZZA	PLIAGE: Relève: Tombe: SENS POLISSAGE: Eclair x note	
		PLAN / CODE	IND.
		<b>SE0051/02</b>	

Ce plan est notre propriété. Il ne peut être copié ni communiqué sans notre autorisation

## PRO 800-900 Electric Tilting Bratt Pan

Nomenclature: Bratt pan ESBM 40L SE0051/01 3~400V SE0051/02

Mark	Code	Designation	Quantity
01	02468A	10 mm <sup>2</sup> terminal (brand: Viking)	3
01	03575A	10 mm <sup>2</sup> earth terminal (brand: Viking)	1
02	02200A	400V contactor	1
03	09031A	1000W-240V heating element	12
04	03413A	Ø 5 mm x 20 mm - 5 A fuse	1
04	02726A	Fuse disconnect terminal block	1
05	07136A	400V red indicator	1
06	07139A	400V yellow indicator	1
07	09088A	400V energy regulator	1
08	01999A	50°C-350°C safety thermostat	1
09	08153A	400V white indicator	1

# PRO 800-900 Electric Tilting Bratt Pan

**PRO900 ESBM 40dm<sup>2</sup>  
sécurité de réarmement  
allumage et régulation  
+ sécurité de basculement.**

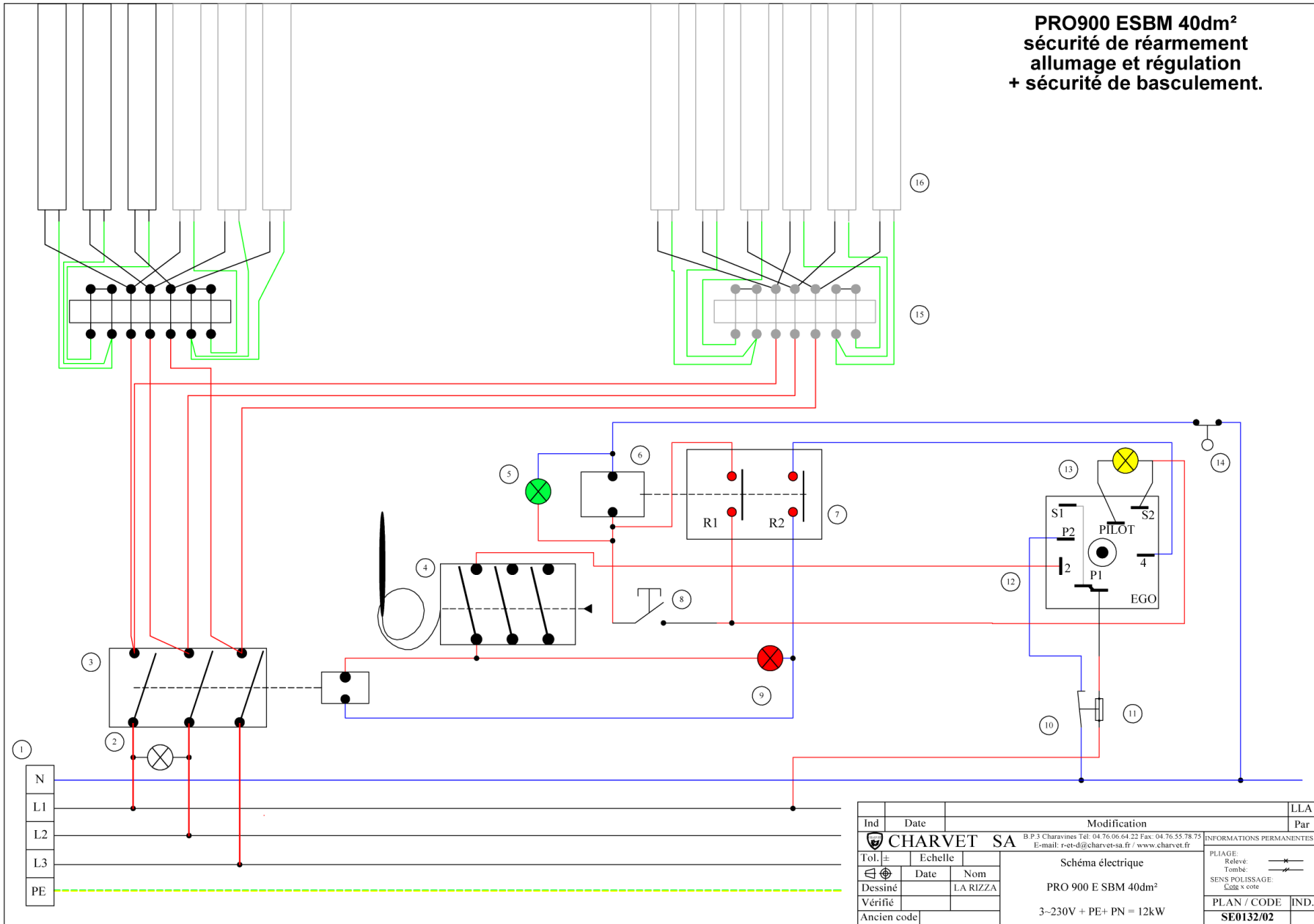

Ind	Date	Modification	LLA
<b>CHARVET SA</b> B.P.3 Charvines Tél: 04.76.06.64.22 Fax: 04.76.55.78.75 E-mail: r-et-d@charvet-sa.fr / www.charvet.fr			Par
Tol. ±	Echelle	Schéma électrique	INFORMATIONS PERMANENTES
Dessiné	Date	PRO 900 E SBM 40dm <sup>2</sup>	PLIAGE: Relève: Tombe: SENS POLISSAGE: Cote x cote
Vérifié	LA RIZZA	3~230V + PE+ PN = 12kW	PLAN / CODE IND.
Ancien code			<b>SE0132/02</b>

Ce plan est notre propriété. Il ne peut être copié ni communiqué sans notre autorisation

## PRO 800-900 Electric Tilting Bratt Pan

Nomenclature: Bratt pan ESBM 40L with safety reset (Optional) SE0132/02

Mark	Code	Designation	Quantity
01	02468A	10 mm <sup>2</sup> terminal (brand: Viking)	3
01	03575A	10 mm <sup>2</sup> earth terminal (brand: Viking)	1
02	00551A	230V contactor	1
03	09031A	1000W-240V heating element	12
04	03413A	Ø 5 mm x 20 mm - 5 A fuse	1
04	02726A	Fuse disconnect terminal block	1
05	07137A	230V red indicator	1
06	07140A	230V yellow indicator	1
07	09099A	230V energy regulator	1
08	01999A	50°C-350°C tripolar safety thermostat	1
09	05091A	Limit switch	1
10	08243A	220V relay	1
11	ELE0018	Reset push-button	1
12	08223A	Green indicator	1
13	08164A	Relay base	1
14	500237	Neutral disconnect terminal block	1
15	08153A	400V white indicator	1



# PRO 800-900 Electric Tilting Bratt Pan

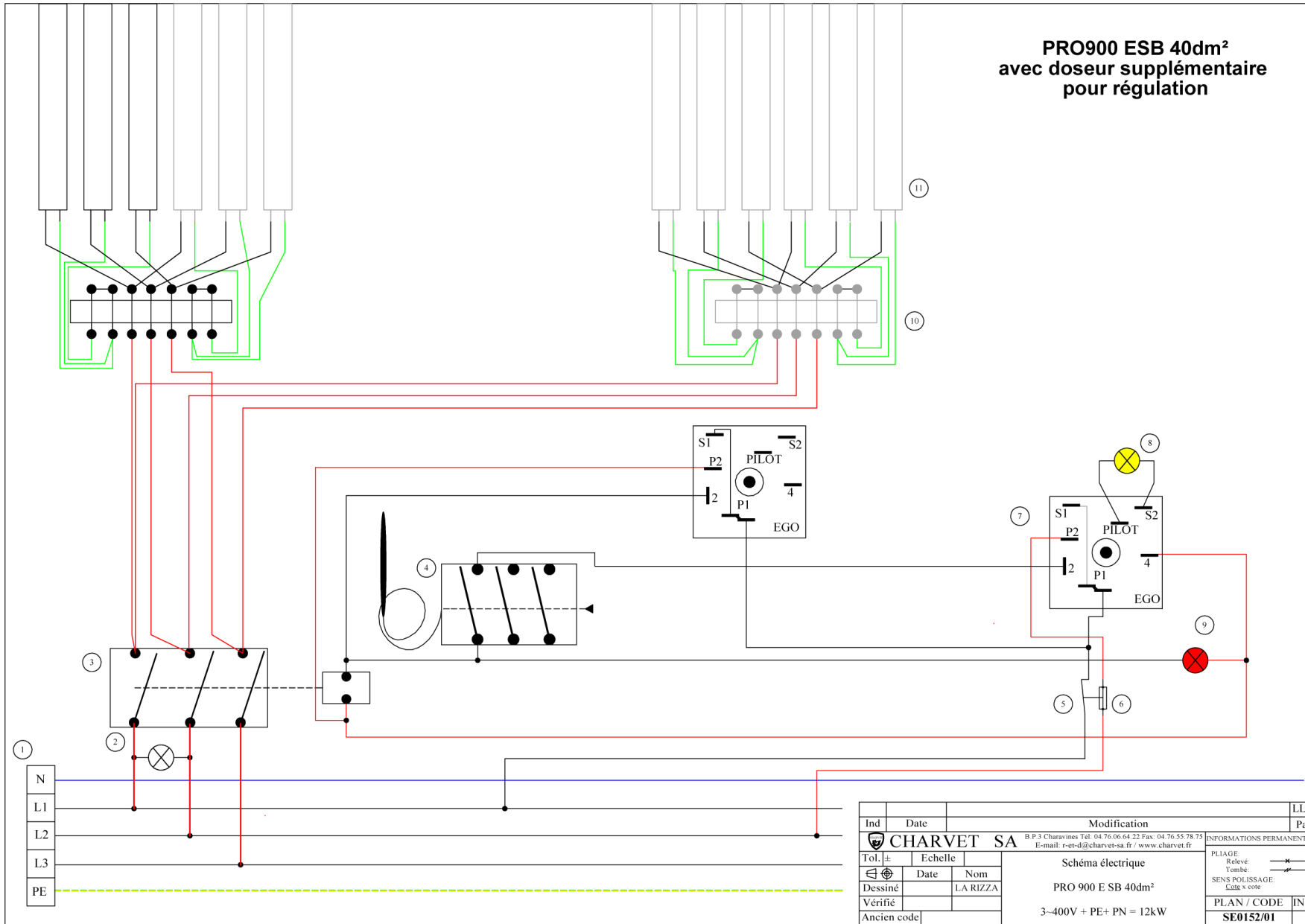

## PRO 800-900 Electric Tilting Bratt Pan

Nomenclature: Bratt pan ESB 40 L Pro 900 (SE0152/00)

Mark	Code	Designation	Quantity
01	02468A	10 mm <sup>2</sup> terminal (brand: Viking)	3
01	03575A	10 mm <sup>2</sup> earth terminal (brand: Viking)	1
02	02200A	400V contactor	1
03	09031A	1000W-240V heating element	12
04	03413A	Ø 5mm x 20mm - 5A fuse	2
04	02726A	Disconnect terminal block	2
05	07136A	Red indicator	1
06/08	09088A	400V energy regulator	1
07	01999A	50°C-350°C tripolar safety thermostat	1
09	07139A	Yellow indicator	1
10	08153A	White indicator	1

# PRO 800-900 Electric Tilting Bratt Pan

**SAUTEUSE  
PRO800 ESBM 33dm<sup>2</sup>**

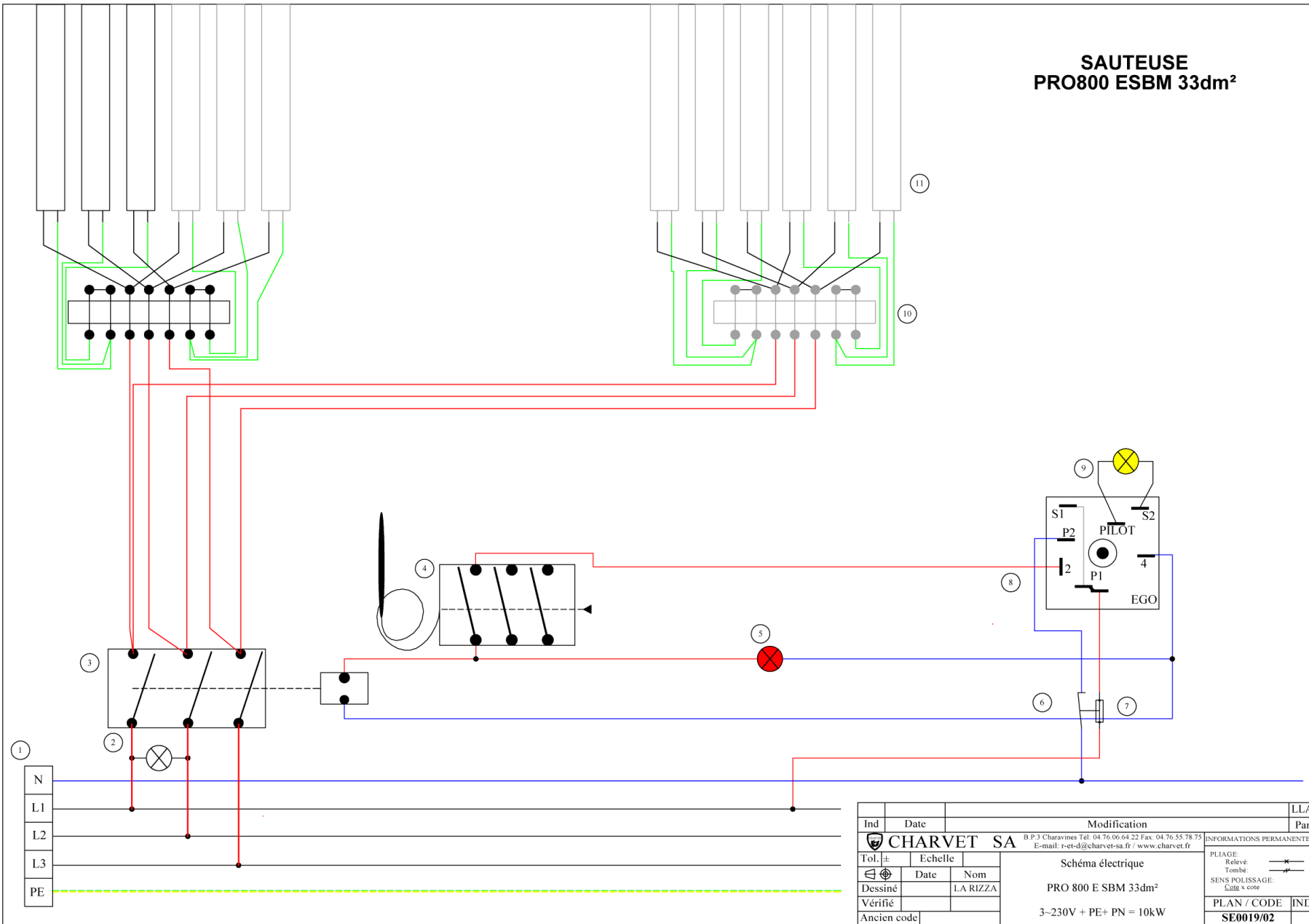

Ind	Date	Modification	LLA
			Par
B.P.3 Charvines Tel: 04.76.06.64.22 Fax: 04.76.55.78.75 E-mail: r-et-d@charvet-sa.fr / www.charvet.fr			INFORMATIONS PERMANENTES
Tol. ±	Echelle	Schéma électrique	
Dessiné	Date	PRO 800 E SBM 33dm <sup>2</sup>	
Vérifié	Nom	3-230V + PE+ PN = 10kW	
Ancien code	LA RIZZA	PLAN / CODE IND.	
			<b>SE0019/02</b>

Ce plan est notre propriété. Il ne peut être copié ni communiqué sans notre autorisation

## PRO 800-900 Electric Tilting Bratt Pan

Nomenclature : Bratt pan ESBM/I.33 3~230V + T SE0019/02

Mark	Code	Designation	Quantity
01	02468A	10 mm <sup>2</sup> terminal (brand: Viking)	3
01	03575A	10 mm <sup>2</sup> earth terminal (brand: Viking)	1
02	00551A	230V contactor	1
03	09033A	850W-240V heating element	12
04	03413A	Ø 5 mm x 20 mm - 5 A fuse	2
05	07137A	230V red indicator	1
05	07140A	230V yellow indicator	1
06	09099A	230V energy regulator	1
07	01999A	50°C-350°C tripolar safety thermostat	1
08	08153A	400V white indicator	1

# PRO 800-900 Electric Tilting Bratt Pan

**SAUTEUSE  
PRO800 ESBM 33dm<sup>2</sup>**

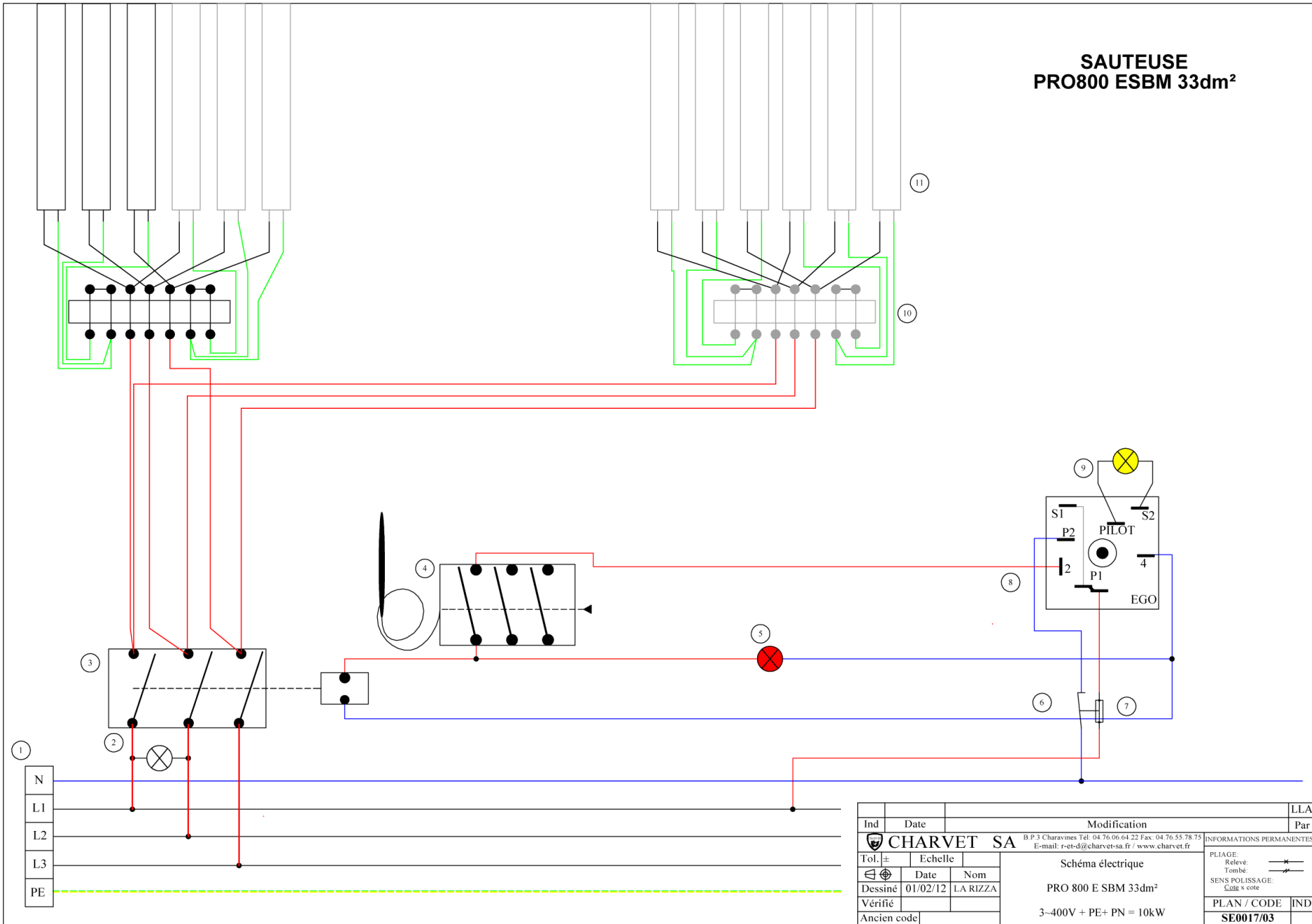

## PRO 800-900 Electric Tilting Bratt Pan

Nomenclature: Bratt pan E SBM/I 33 3~400V SE0017/03

Mark	Code	Designation	Quantity
01	02468A	10 mm <sup>2</sup> terminal (brand: Viking)	3
01	03575A	10 mm <sup>2</sup> earth terminal (brand: Viking)	1
02	02200A	400V contactor	1
03	09033A	850W-230V heating element	12
04	03413A	Ø 5 mm x 20 mm - 5 A fuse	2
05	07136A	400V red indicator	1
06	09088A	400V energy regulator	1
07	07139A	400V yellow indicator	1
08	01999A	50°C-350°C tripolar safety thermostat	1
09	08153A	400V white indicator	1

# PRO 800-900 Electric Tilting Bratt Pan

**PRO 800 ESB 33 dm<sup>2</sup>  
avec doseur supplémentaire  
pour régulation**

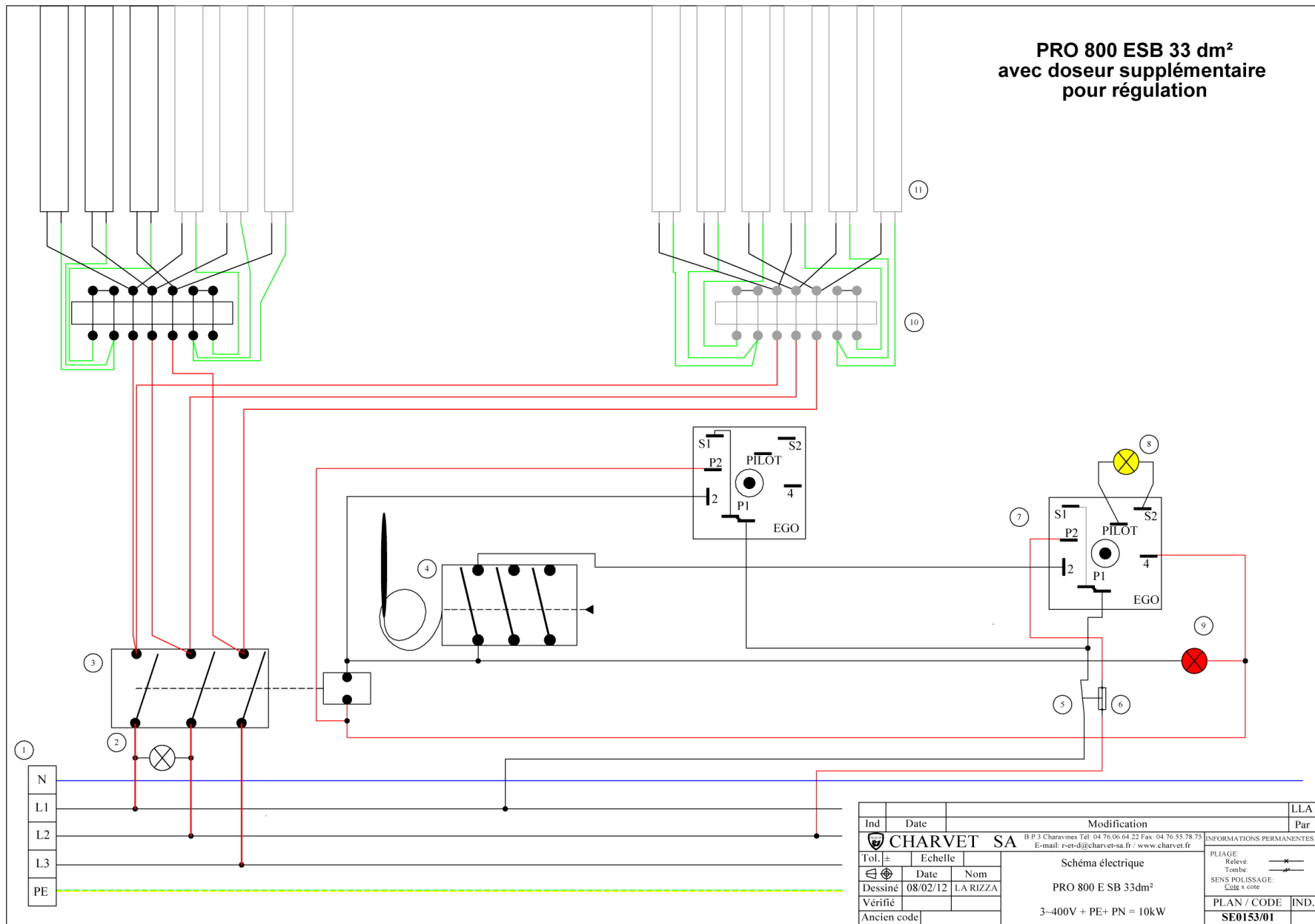

Ind	Date	Modification		LLA
				Par
<b>CHARVET SA</b>		B.P. 3 Charvres Tel: 04 76 06 64 22 Fax: 04 76 55 78 75 E-mail: r-et-d@charvet-sa.fr / www.charvet.fr		INFORMATIONS PERMANENTES
Tol. ±	Echelle	Schéma électrique		PLIAGE: Relève:
Dessiné	Date	Nom	PRO 800 E SB 33dm <sup>2</sup>	Tombe:
Vérifié	08/02/12	LA RIZZA		SENS POLISSAGE: Cote x cote
Ancien code			3-400V + PE+ PN = 10kW	PLAN / CODE
				<b>SE0153/01</b>

Ce plan est notre propriété. Il ne peut être copié ni communiqué sans notre autorisation

## PRO 800-900 Electric Tilting Bratt Pan

Nomenclature: Bratt pan ESB 33L Pro 800 (SE0153/00)

Mark	Code	Designation	Quantity
01	02468A	10 mm <sup>2</sup> terminal (brand: Viking)	3
01	03575A	10 mm <sup>2</sup> earth terminal (brand: Viking)	1
02	02200A	400V contactor	1
03	09033A	850W-240V heating element	12
04	03413A	Ø 5mm x 20mm - 5A fuse	2
04	02726A	Disconnect terminal block	2
05	07136A	Red indicator	1
06/08	09088A	400V energy regulator	1
07	01999A	50°C-350°C tripolar safety thermostat	1
09	07139A	Yellow indicator	1
10	08153A	400V white indicator	1



# PRO 800-900 Electric Tilting Bratt Pan

**PRO900 ESBM 40dm<sup>2</sup>**  
**sécurité de réarmement**  
**allumage et régulation**  
**+ sécurité de basculement.**

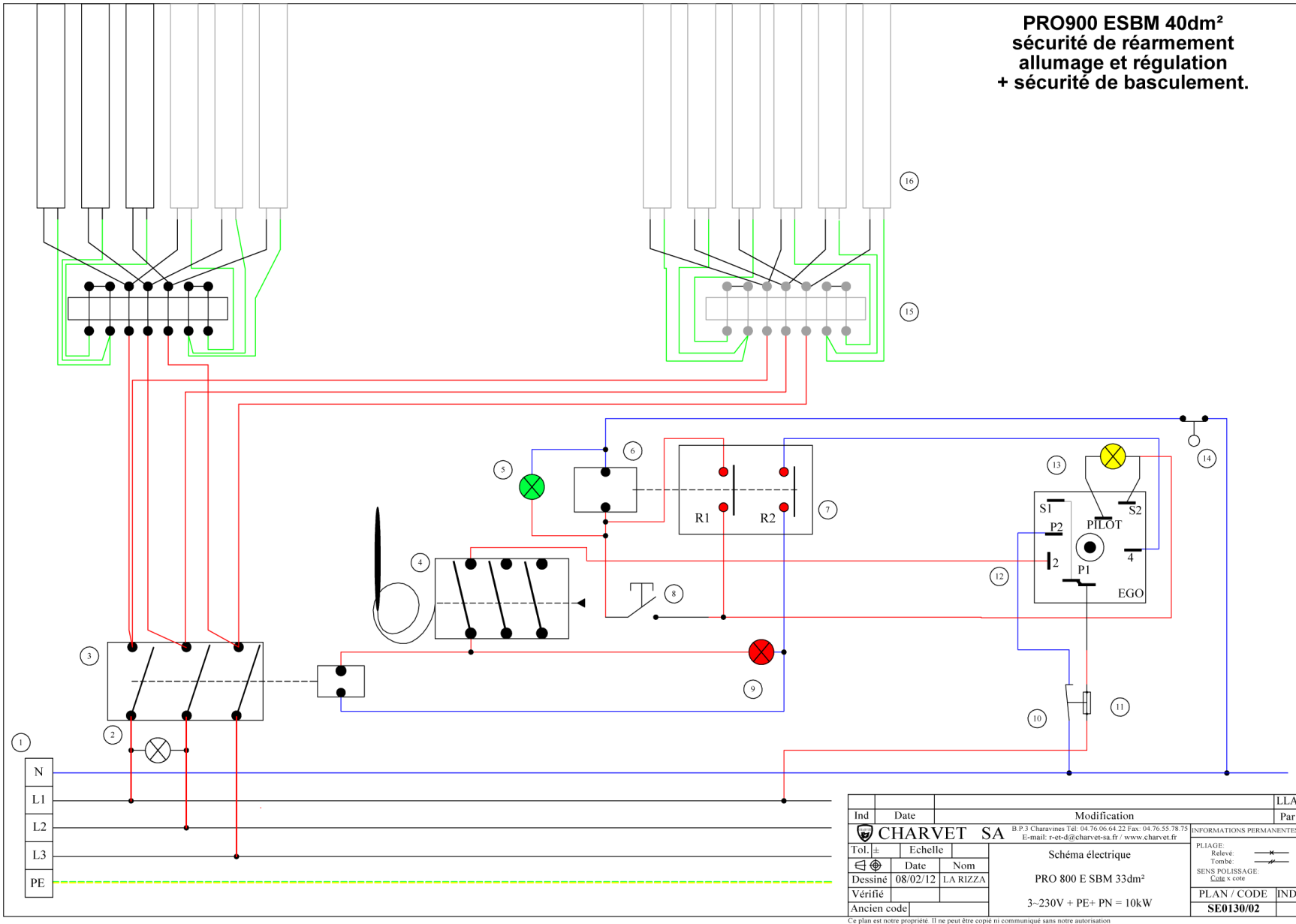

Ind	Date	Modification	LLA
			Par
<b>CHARVET SA</b> B.P.3 Charvines Tel: 04.76.06.64.22 Fax: 04.76.55.78.75 E-mail: r-et-d@charvet-sa.fr / www.charvet.fr			
Tol. ±	Echelle	Schéma électrique	
⊕	Date	PRO 800 E SBM 33dm <sup>2</sup>	
Dessiné	08/02/12	LA RIZZA	3~230V + PE+ PN = 10kW
Vérifié			
Ancien code			
INFORMATIONS PERMANENTES			
PLIAGE: Relevé:			
Tombe:			
SENS POLISSAGE:			
Code à copier			
PLAN / CODE		IND.	
<b>SE0130/02</b>			

Ce plan est notre propriété. Il ne peut être copié ni communiqué sans notre autorisation

## PRO 800-900 Electric Tilting Bratt Pan

Nomenclature: Bratt pan ESB 33L 3~230V + T (SE0130/02) (Optional)

Mark	Code	Designation	Quantity
01	02468A	10 mm <sup>2</sup> terminal (brand: Viking)	3
01	03575A	10 mm <sup>2</sup> earth terminal (brand: Viking)	1
02	00551A	230V contactor	1
03	09033A	850W-240V heating element	12
04	03413A	Ø 5 mm x 20 mm - 5 A fuse	1
04	02726A	Fuse disconnect terminal block	1
05	07137A	230V red indicator	1
06	07140A	230V yellow indicator	1
07	09099A	230V energy regulator	1
08	01999A	350°C safety thermostat	1
09	05091A	Limit switch	1
10	08243A	220V relay	1
11	ele0018	Reset push-button	1
12	08223A	Green indicator	1
13	08164A	Relay base	2
14	500237	Neutral disconnect terminal block	1
15	08153A	White indicator	1

# PRO 800-900 Electric Tilting Bratt Pan

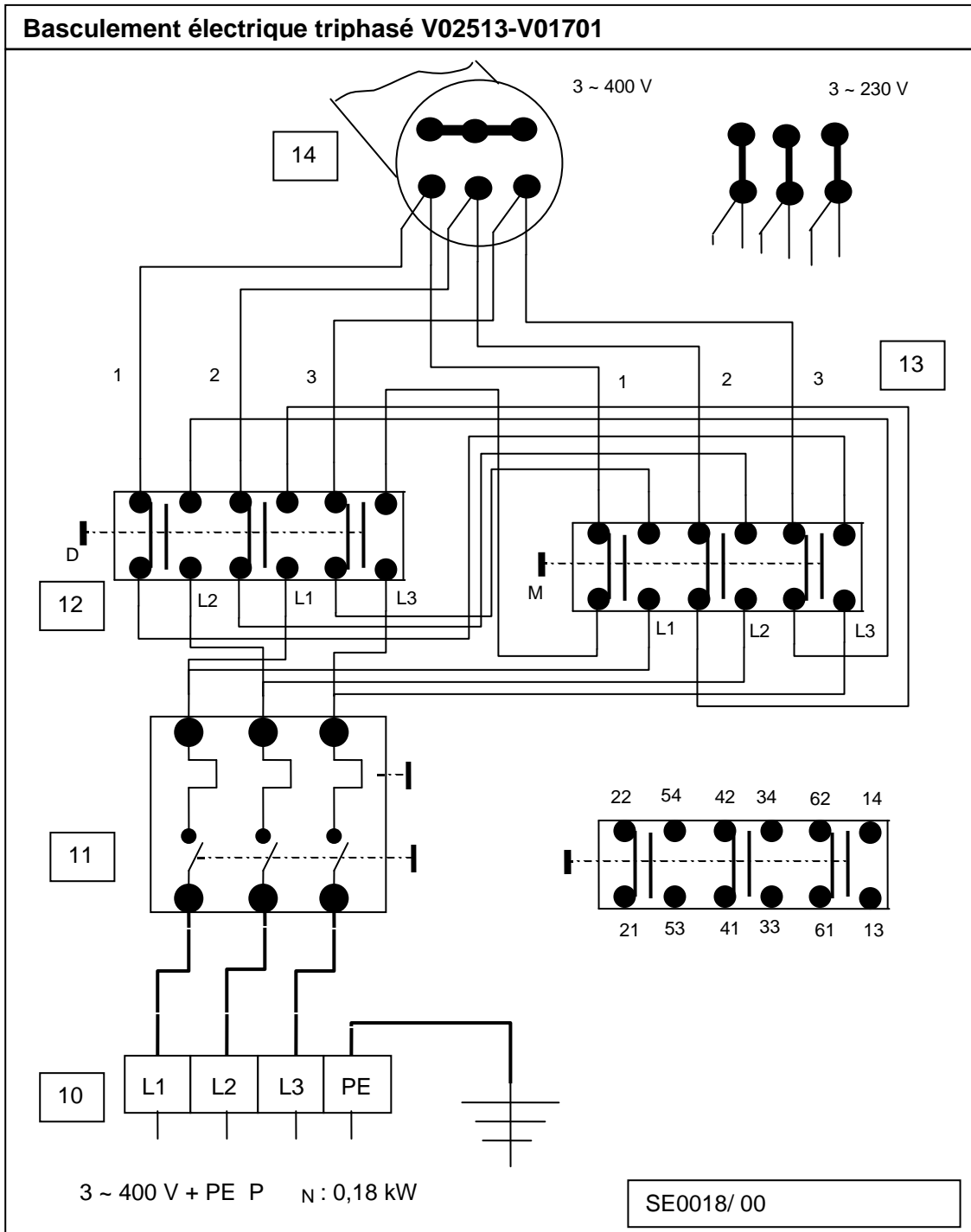











**NOMENCLATURE: Three-phase electric tilting mechanism (wiring diagrams: SE0018/ 00)**



Mark	Code	Designation	Quantity
10	02468A	10 mm <sup>2</sup> terminal (brand: Viking)	3
10	03575A	10 mm <sup>2</sup> earth terminal (brand: Viking)	1
11	03775A	Circuit breaker	1
12	02522A	Push-button (DOWN)	1
13	02521A	Push-button (UP)	1
14	03475A	Electric actuator	1
15	08153A	400V white indicator	1

PRO 800-900 Electric Tilting Bratt Pan

4. FIRST AID SPARE PARTS LIST



Designation / Code	Photograph	Designation / Code	Photograph
Indicator Red 07136A 400V 07137A 230V Yellow 07139A 400V 07140A 230V		Contactor 400V coil 02200A 230V coil 00551A	
Indicator White 08153A 400V Green 08223A 400V		Heating element 850W 230V 33L-50L 505335 1000W 240V 40L-60L 505301	
Transformer 05917A		Energy regulator 400V 09088A 230V 09099A	
350°C thermostat 01999A		Push-button UP 02521A DOWN 02522A	
Gear Kit 33 & 40 dm <sup>2</sup> 50-60 dm <sup>2</sup> F15731		220V 08243A relay	
		Relay base 08164A	

**PRO 800-900 Electric Tilting Bratt Pan**

Designation / Code	Photograph	Designation / Code	Photograph
Wheel 169721		Push-button ELE0018	
Electric actuator 03475A		Electric igniter 240V 02161A	
33 & 40 gas spring 07780A		High voltage cable 03013A	
Solenoid valve 05405A		Electrode 05315A	
Limit switch 05092A 05091A		Steatite barrier strip 02465A	

5. MAINTENANCE:

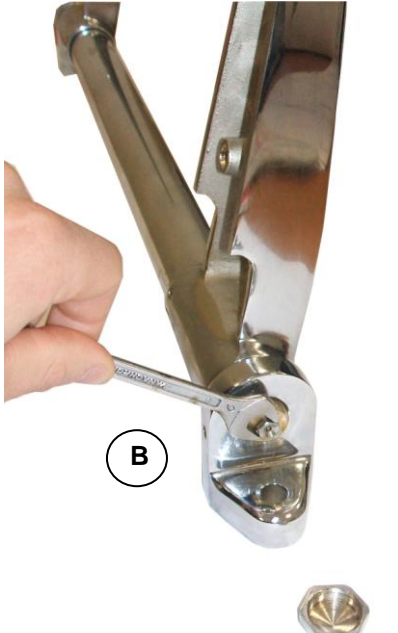
5.1. Adjusting the balanced lid (Optional):

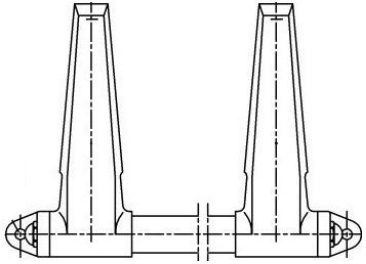
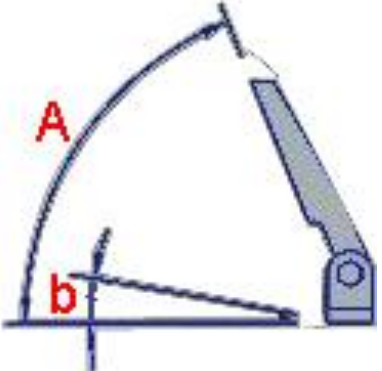
 <p><b>A</b></p>	 <p><b>B</b></p>	 <p><b>C</b></p>
		<p><b>Possible opening angles (A):</b></p> <ol style="list-style-type: none"> <li>1. 65°</li> <li>2. 70°</li> <li>3. 75°</li> <li>4. 80°</li> <li>5. 85°</li> <li>6. 90°</li> </ol> <p><b>Minimum opening angle (B):</b></p> <ol style="list-style-type: none"> <li>1. 10°</li> </ol>
<ul style="list-style-type: none"> <li>• Remove the plug (a) with a 24mm open-end spanner</li> <li>• Then, use a 9mm open-end spanner (b) to remove the nut.</li> <li>• Adjust with a hex key (c) (refer to the opening angles above)</li> </ul>		

5.2. Changing the bratt pan heating element.

Fig.1

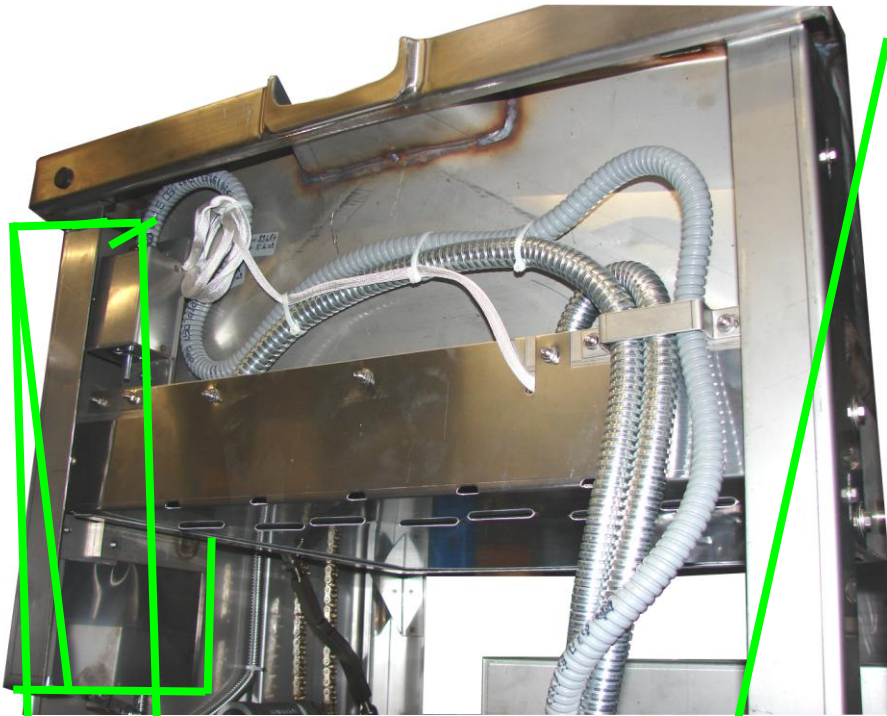
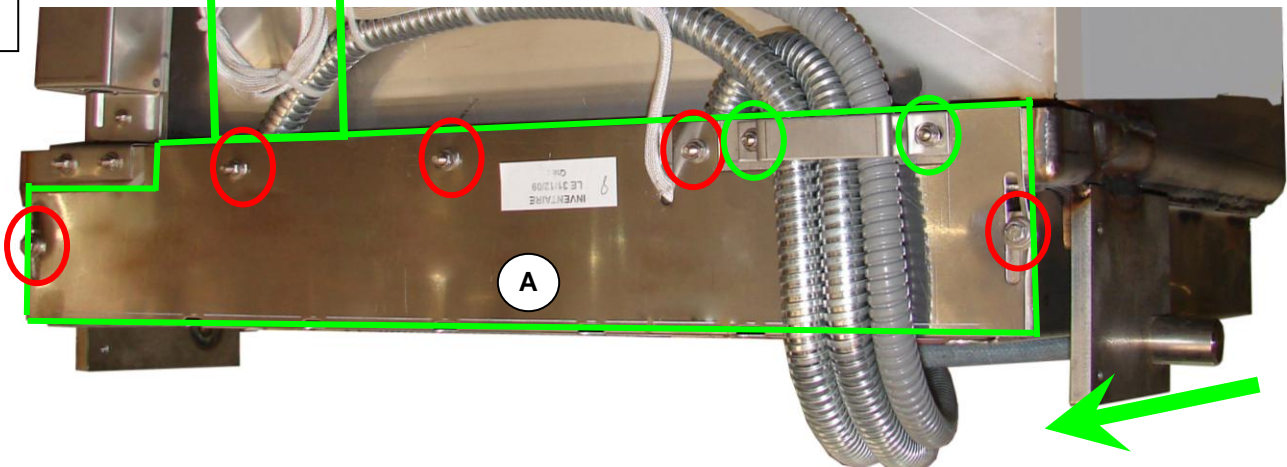
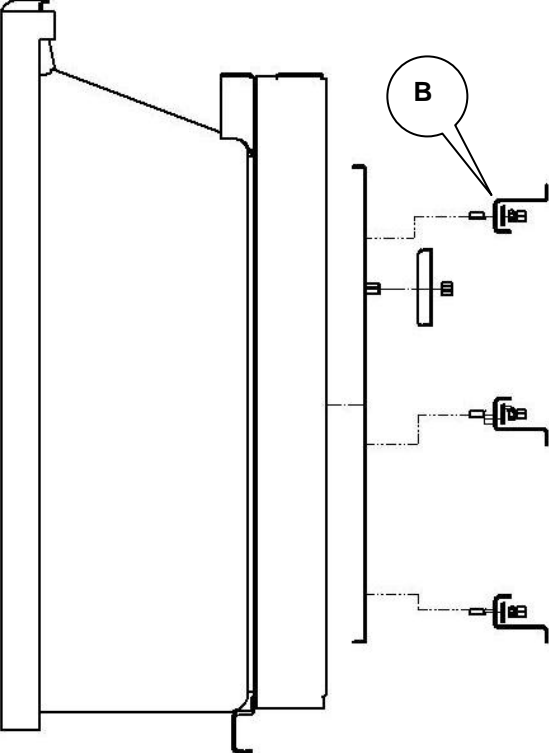
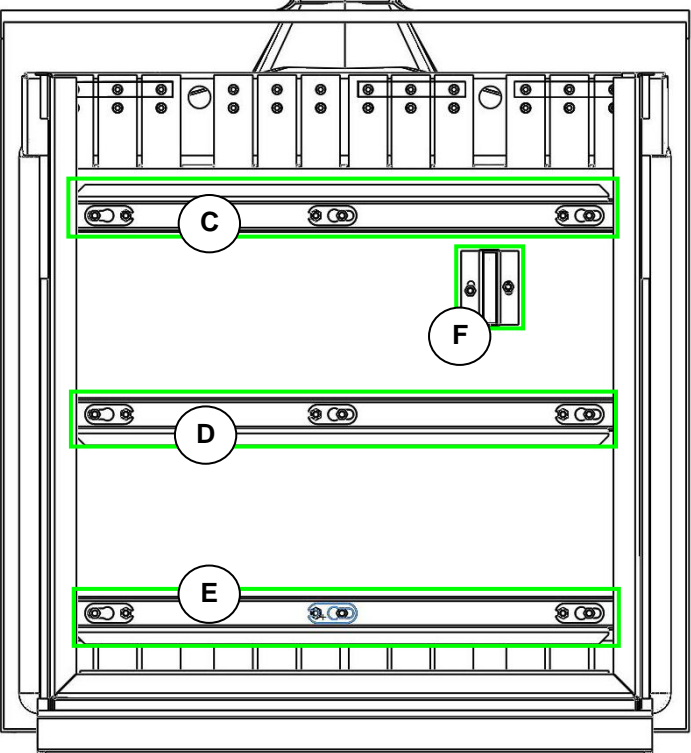
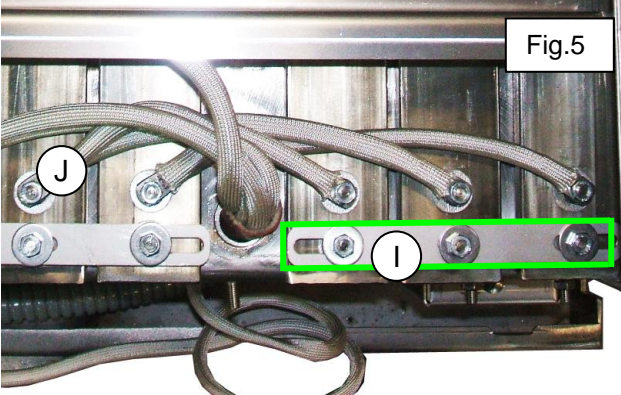
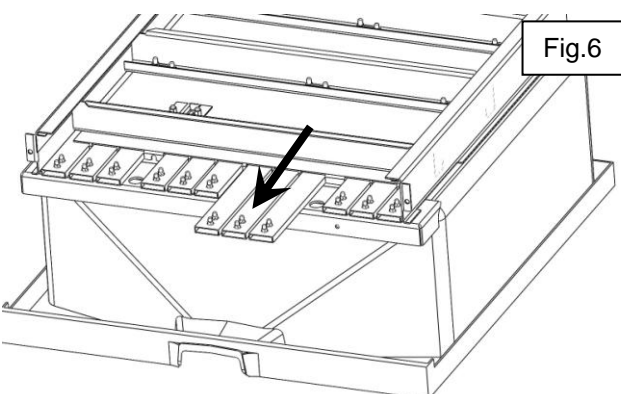

Fig.2



1. Remove the control panel (fixed with 2 screws)  
Remove the front panel (fixed with 4 screws)
2. Remove the two side panels of the tank (fig. 1)
3. Remove the heating element protection. (A) (fixed with 6 screws), then pull the protection towards you.

# PRO 800-900 Electric Tilting Bratt Pan

 <p>Fig.3</p>	 <p>Fig.4</p>
 <p>Fig.5</p>	 <p>Fig.6</p>
<p>4) Unscrew the various fixings (B)          5) Remove the rod heating elements (I)          Disconnect electrical connections (J)</p>	<p>C and E: External heating element fixings.          D: Internal fixings          F: Bulb fixings</p>



# Electric Bratt pan

---

Designation	PRO 800 SERIES		PRO 900 SERIES	
E1SBM33I/50I	V02685	V01700		
E1SBE33I/50I	V02513	V01701		
E1SBM40I/60I			V02687	V02074
E1SBE40I/60I			V02005	V02006

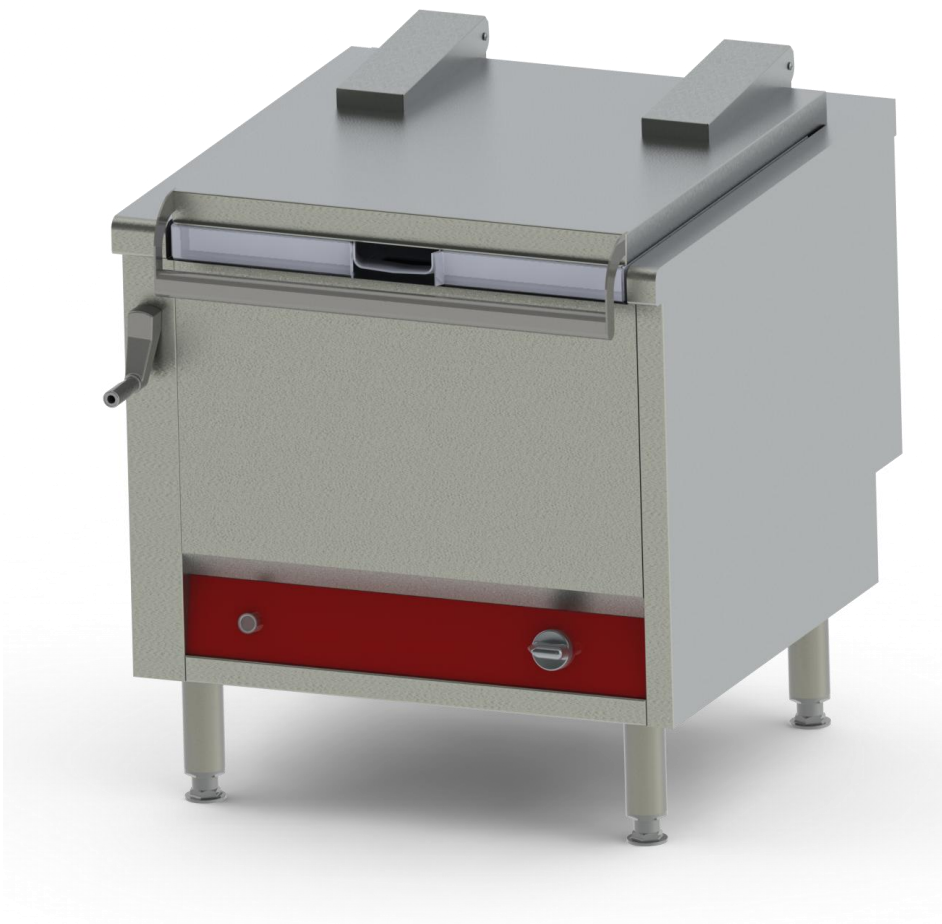

## **USER INSTRUCTIONS**

## TABLE OF CONTENTS

<b>USER INSTRUCTIONS</b> .....	<b>1</b>
<b>1. INTRODUCTION:</b> .....	<b>3</b>
<b>2. PRIOR TO STARTING UP</b> .....	<b>3</b>
<b>3. STARTING UP</b> .....	<b>4</b>
3.1. <b>ELECTRIC BRATT PAN:</b> .....	<b>4</b>
3.2. <b>TANK TILTING PROCEDURE</b> .....	<b>5</b>
3.3. <b>FITTING THE REMOVABLE DRAINING BOARD. (OPTIONAL)</b> .....	<b>5</b>
<b>4. SWITCHING OFF</b> .....	<b>6</b>
<b>5. MAINTENANCE</b> .....	<b>6</b>
5.1. <b>CLEANING OF THE STAINLESS STEEL SURFACES:</b> .....	<b>6</b>
5.2. <b>CLEANING THE TANK</b> .....	<b>6</b>
5.3. <b>CLEANING THE BURNER</b> .....	<b>6</b>
<b>6. TROUBLESHOOTING</b> .....	<b>7</b>
6.1. <b>UNSATISFACTORY HEATING:</b> .....	<b>7</b>

# PRO 800-900 Electric Tilting Bratt Pan

## Warnings

***It is important to turn off the heating element before each cleaning.  
Do not heat the tank for an extended period of time whilst empty.***

**The bratt pan should not be used for deep frying. (European Standard EN 203-2-8)  
Misuse can cause severe damage to the appliance or put in danger goods and people around.  
We cannot be held responsible if the user(s) neglect to follow these instructions.**

About the regulation option: when the maximum temperature is reached, the red heating indicator turns off and the second energy regulator maintains the temperature at 350°C.  
Set the energy regulator on the control panel to 80% to avoid overloading the tank.

### 1. INTRODUCTION:

- A) Our appliances are for professional use only and must be used by qualified staff.
- B) The appliances must be installed in compliance with regulations and standards in force in the country of installation, in an adequately aerated room, equipped with an air extraction hood.
- C) Appliances may be installed side by side or against walls of non-combustible material but they must remain at a distance of no less than 10 cm to combustible material.
- D) It is imperative to hire a qualified installer for all new installations or modifications of existing equipment.
- E) WARRANTY: *The warranty is discussed in our sale contract. Call a registered dealer for any warranty work. This warranty does not cover damage due to faulty installation, misuse or inadequate maintenance.*

### 2. PRIOR TO STARTING UP

- a) Remove all plastic protection wrapping the stainless steel panels.
  - b) Make sure that all controls are in good working condition.
  - c) Prior to starting up, it is advisable to clean the appliance in order to eliminate all dust and impurities that have accumulated during storage.
- To this end, fill up the tank with water (1-2 cm high).
- d) Turn the appliance on (for about 10 minutes).
  - e) Then, turn it off.
  - f) Tilt the tank to drain (see tank tilting § 3.2.).
  - g) Clean the tank with a sponge to eliminate all remaining impurities.

# PRO 800-900 Electric Tilting Bratt Pan



## 3. STARTING UP

### 3.1. Electric bratt pan:

The appliance is ON (white indicator)

- a) Set the energy regulator control knob to the "100" mark (continuous heating); the yellow indicator (the energy regulator is switched on) and the red one (the apparatus is heating up) are alight.

The preheating phase lasts about 15 minutes; you can start cooking after this period of time. Temperature is evenly distributed on the cooking plate to allow cooking operations across the whole surface.

	
Standard bratt pan or (Optional = bratt pan with energy regulator)	
	
Optional = Bratt pan with safety reset or Optional = Safety reset and energy regulator.	
<ul style="list-style-type: none"><li>1. Energy regulator knob</li><li>2. Reset push-button</li><li>3. Green indicator : regulation</li><li>4. Yellow indicator : ON</li><li>5. White indicator: power on</li><li>6. Red indicator: Heating up</li></ul>	

## PRO 800-900 Electric Tilting Bratt Pan

### 3.2. Tank tilting procedure

		
<ul style="list-style-type: none"><li>• Pull the wheel towards you, then turn clockwise to tilt the tank down.</li></ul> <p>Electric tilting mechanism option: A: UP B: DOWN</p>		

### 3.3. Fitting the removable draining board. (Optional)

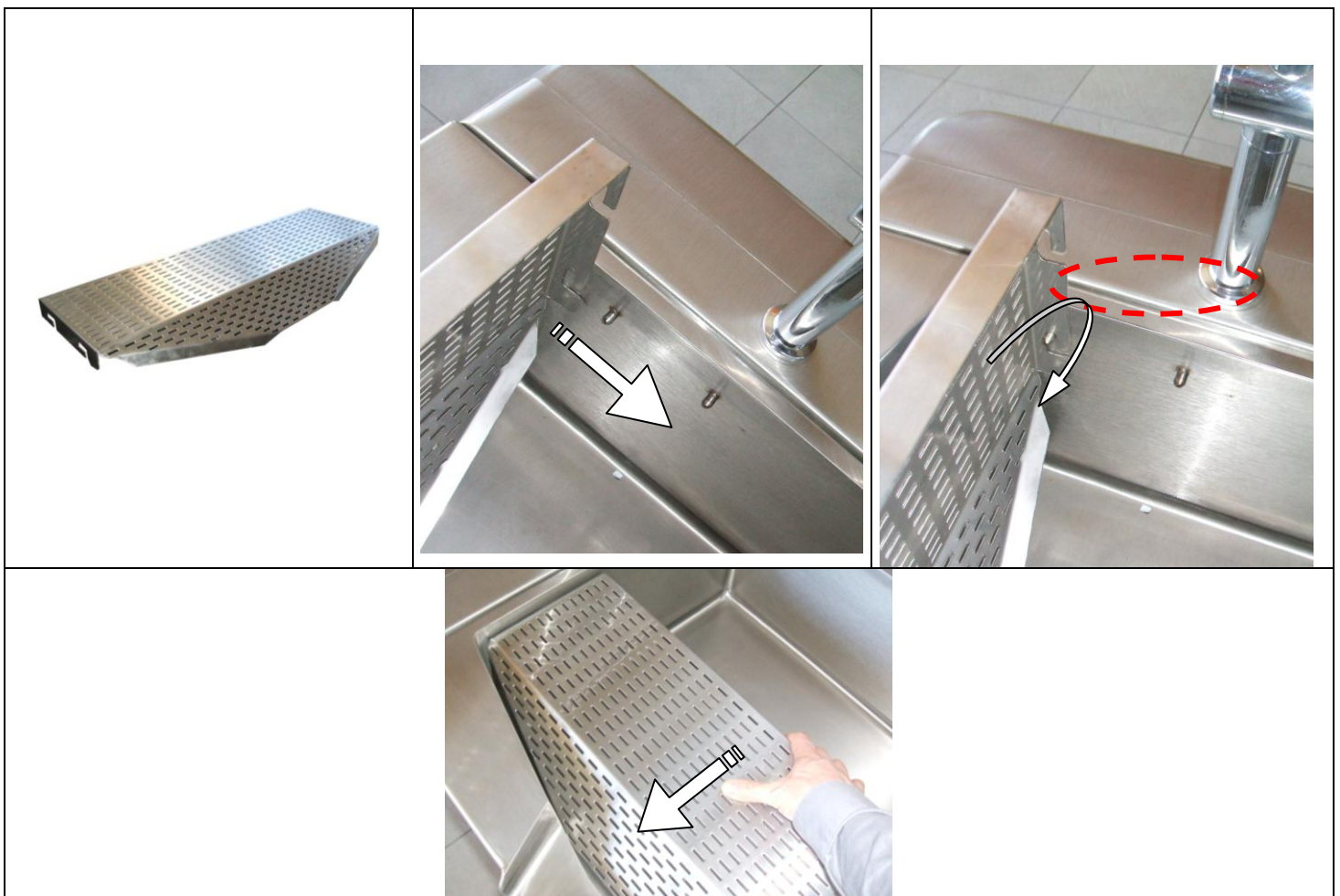

## PRO 800-900 Electric Tilting Bratt Pan

***Warning:*** When opening the lid during "wet" cooking operations, be careful of the escaping steam to avoid any risk of burns as the arm passes over the tank.

**When emptying:**

- Stay clear of the cooked product pouring zone: risk of splash burns.
- Follow tank movement to control pouring in the spout area.
- Tilt the tank backwards to its idle position to avoid spillage of products when changing collecting containers.

**The tank sides may be very hot after an intensive and extended period of use; use only the tilting handle to tilt the tank.**

### 4. SWITCHING OFF

Bring the command knob back to the position: 0  
Wait until cooking areas have cooled down to a bearable temperature.  
Clean the tank carefully after each use  
(Avoid drying of food scraps and overflowing liquids).

At the end of the day, switch the power off at the mains.

### 5. MAINTENANCE

#### 5.1. Cleaning of the stainless steel surfaces:

- a) Switch off the appliance.
- b) Wait until the apparatus has cooled down before any intervention.
- c) Wash with a sponge and soapy water (or any other neutral detergent).

Do not use bleach or any other acidic product - even well diluted.

For the top parts, use a scouring pad if necessary. **Always scour with the grain.**

- d) After each cleaning, rub with an oily rag.
- e) Finger marks can be removed with a cloth dabbed with alcohol.

#### 5.2. Cleaning the tank

Cleaning can be done by soaking with soapy water.

If coarse salt is poured into the tank during dry-cooking or semi-moist cooking, thoroughly rinse the bottom of the tank with clear water to remove all salt particles. Otherwise it will corrode the stainless steel tank.

#### 5.3. Cleaning the burner

If the burner needs to be cleaned, please call your installer.

**The burner must not be cleaned with splashes or water jets under pressure.  
Check that the appliance is powered off at the mains.**

**THE ENGINE OF THE ELECTRIC ACTUATOR MUST NOT BE SUBJECTED TO SPLASHES. AS THERE IS A RISK OF ENGINE DETERIORATION.**

## PRO 800-900 Electric Tilting Bratt Pan

For best results, it is advisable to have your equipment serviced by a qualified installer on a regular basis depending on the intensity of utilization.

**WARNING:** Certain parts of this appliance are protected by the manufacturer, and must not be handled by the installer or the user.

### 6. TROUBLESHOOTING

#### 6.1. Unsatisfactory heating:

The switched-on indicator is alight but the tank is not heating up:

- . ***Incorrectly positioned tank:*** manoeuvre the tank using the tilting handle to engage the positioning microswitch, .

- . Energy regulator failure,
- . Overheat thermostat failure (regulator indicator off)
- . Heater contactor failure.

BADLY DISTRIBUTED HEAT:

- . Faulty heating elements.

Contact the installer in order to replace command parts or heating elements for further use.





**Only a qualified electrician can replace the ignition transformers.**

**The manufacturer and the installer cannot be held responsible if the user fails to ask for assistance in case of malfunction.**

**TRANSFER below the information written on the DATA PLATE of your appliance.**

This information will facilitate communication between you and your installer regarding maintenance problems and spare parts.

PRO 800-900 Electric Tilting Bratt Pan

	<b>CHARVET S.A.</b> <b>38850 CHARAVINES</b>
Réf.	<input style="width: 100%;" type="text"/>
Code:	<input style="width: 50%;" type="text"/> Type: <input style="width: 50%;" type="text"/>
N°FC:	<input style="width: 50%;" type="text"/> <input style="width: 50%;" type="text"/>
N°OF:	<input style="width: 50%;" type="text"/> Rep. <input style="width: 50%;" type="text"/>
Cat.	<input style="width: 100%;" type="text"/>
Gaz	<input style="width: 100%;" type="text"/>
P (mbar)	<input style="width: 100%;" type="text"/>
$\Sigma Q_n$ (kW)	<input style="width: 100%;" type="text"/>
$\Sigma V_n$ (m <sup>3</sup> /h)	<input style="width: 100%;" type="text"/>
$\Sigma M_n$ (kg/h)	<input style="width: 100%;" type="text"/>
U	<input style="width: 20%;" type="text"/> V <input style="width: 20%;" type="text"/> Hz Ip <input style="width: 20%;" type="text"/>
P	<input style="width: 20%;" type="text"/> kW <input style="width: 60%;" type="text"/>
	<input style="width: 100%;" type="text"/>
MADE IN FRANCE	