

Gas-powered single unit
G3FN/PL-B-G3FN/PL- G3PL/FN-B-G3PL/FN

Series: Pro 1000 with 'volcano' burners



- V02472 Pro 1000 G3FN/ PL** Single unit 2FN/1PL/ Gas oven
- V02474 Pro 1000 B-G3FN/PL** Single unit 2FN/1PL/ Open cabinet
- V02446 Pro 1000 G3PL/ FN** Single unit 1PL/2FN/ Gas oven
- V02471 Pro 1000 B-G3PL/FN** Single unit 1PL/2FN/ Open cabinet

Option: Electric ignition
Water tank

Installation manual

Gas-powered single unit

G3FN/PL-B-G3FN/PL- G3PL/FN-B-G3PL/FN

'Compliance with French Decree No. 2005-829 of 20 July 2005.' **Exclusively for France**

A - In accordance with Article 18 of Decree No. 2005-829 of 20 July 2005 on the disposal of waste electrical and electronic equipment, the Paul CHARVET company takes responsibility for the financing and organisation of the disposal of its waste. As such, the Paul CHARVET company resumes full ownership of the electrical and electronic equipment at the end of its life.

The equipment should be palletised and ready for loading in a place that is accessible by the carrier. Except in exceptional circumstances, the equipment shall in no case have been dismantled, even partially, otherwise CHARVET reserves the right to re-invoice the costs of processing and taking responsibility for the equipment.

B- How WEEE is disposed of:

The terms and conditions of disposal are covered by the SYNEG/RECYSTEM-PRO agreement, which states that: "In order to fulfil their obligations, the producers of electrical and electronic equipment for large kitchens grouped within the SYNEG, have implemented arrangements for the collection and processing/recycling of WEEE in accordance with the provisions of the decree.

Materials or substances harmful to the environment (such as refrigerants or foams) are extracted or separated. The metal fractions (stainless steel, zinc, copper, etc.) are crushed and transported to refiners for reuse. Therefore, when you need to have electrical equipment collected by a SYNEG professional kitchen equipment manufacturer, you must contact RECYSTEM-PRO, the operator chosen for the management of WEEE

→ at this telephone number: 01 45 01 71 43.

→ or at the following e-mail address: synegdeee@recystempro.com

You will then be sent a collection request sheet which will contain the following elements:

- name of the producer of the equipment
- type of equipment
- estimated weight
- place of collection
- name and contact details of the installer
- invoicing address

After verification with the producer and obtaining its agreement, RECYSTEM-PRO will proceed with the collection."

"This device complies with the 2009/142 (Declaration of conformity to type) directive"



Gas-powered single unit

G3FN/PL-B-G3FN/PL- G3PL/FN-B-G3PL/FN

1. INSTALLATION

1.1. General

The equipment must be installed in a room with adequate ventilation, equipped with an air extraction system, according to the regulations and standards in force in the country of installation and the instructions contained in this manual.

This appliance is an A-type and must not be connected to a flue gas pipe.

The user manual must be handed over to the user after installation.

1.2. Handling - Positioning

It is imperative to leave the appliance on its wooden pallet during the handling process until the final installation. Unpack and check the appliance for damage upon receipt.

In case of damage, detail it immediately on the delivery note; notify the carrier by registered mail with acknowledgement of receipt within 48 hours.

1.3. Installation

Special attention should be paid to the local fire prevention regulations of the establishment (see regulations applicable to establishments that are open to the public.)

The appliance must be installed under an extraction hood.

If the appliance is to be installed against a wall or partition, near a piece of furniture or decorative borders, it is recommended that these are made of fireproof material.

If this is not the case, they must be protected by an approved fireproof, insulating material.

In case of doubt regarding materials, allow a 10 cm space around your appliance.

Remove all protective plastic wrapping from the outer panels.

Put the appliance in its working location in the cooking area near the gas supply necessary for its operation.

Warning



- **Fixed appliance:**

Fit the legs or adjusting bolts (these are delivered in a separate box).

Level the appliance by adjusting the height of the legs to obtain the height of the horizontal worktop.

- **Mobile appliance:**

Fit the legs (these are delivered in a separate box).

The brakes on the castors must be in locked position when the appliance is in position for connection and when the cooking function is in operation.

Gas-powered single unit

G3FN/PL-B-G3FN/PL- G3PL/FN-B-G3PL/FN

Interventions:

Any intervention or repair on an appliance must be undertaken by a qualified installer.
The apparatus will be isolated from the gas network by closing the gas valve



When the installation is complete, train users on the proper use of the appliance. (see the user manual)

Warranty: The warranty is part of the sale contract.
This warranty does not cover any damages due to faulty installation, misuse or inadequate maintenance.

- **Data plate**

Each appliance has a data plate. Record the information on the appliance's data plate in the part of the manual reserved for that purpose. (see last page)

This will make it easier for you to communicate with your customer for better service delivery.

	
Position of the plate on G3FN/PL-G3PL/ FN	Position of the plate on B-G3FN/PL- B-G3PL/FN

Gas-powered single unit



G3FN/PL-B-G3FN/PL- G3PL/FN-B-G3PL/FN

1.4. Mounting the flue*

LOWER FLUE ASSEMBLY

- Description:

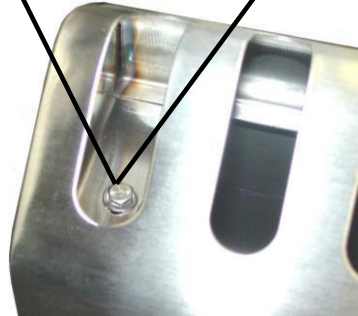
Attach the discharge flue to the top of the appliance and make sure that nothing is clogging the flue (inside/outside).
***Not applicable to V02474 / V02471**

<p>Two fixing screws, on the right and the left, can be reached from the top of the flue. (fig.1) and (fig.2)</p>	<p style="text-align: center;">Fig.1</p> 
<p>Remove the screws to lower the retaining tabs under the flue on the left and right sides. (Fig.3)</p>	<p style="text-align: center;">Fig.2</p> 
<p>Place the flue above its housing, slide the retaining tabs under the top, and reposition the tabs by refitting the screws mentioned above. (Fig.2)</p>	<p style="text-align: center;">Fig.3</p> 

✓ GAS PART

Warning



- **Fixed appliance:**

Connect the appliance on its standby manifold (½" male pipe threaded for gas) to the fixed gas supply pipe, inserting a block valve so that the appliance can be isolated from the rest of the installation.

- **Mobile appliance:**

Connect the appliance on its standby manifold (½" male pipe threaded for gas) to the fixed gas supply pipe using an authorised gas hose, inserting a block valve so that the appliance can be isolated from the rest of the installation.
 Install the anti-wrench system.

2. Controls and checks before gas connection:



Gas-powered single unit

G3FN/PL-B-G3FN/PL- G3PL/FN-B-G3PL/FN

- **Control and checking points:**

- The conformity of the supply pressure and the type of gas with the appliance setting.
- The cleanliness of the pipeline,
- That the gas supply pipeline is correctly sized so as to minimise pressure drops, the diameter is determined according to the power of the appliance, the gas pressure, the path travelled (length and number of elbows).
- The new air flow

That the new air flow to supply combustion is 2 m³/h/kW. (See Table B)

- The type of gas used

Check that the appliance is set for the type of gas delivered to the installation (type/pressure), this information is on the label near the gas connection.

Table B			
Code	Appliance type	Power (kW)	Required new air flow (in m ³ /h/ kW)
V02472	G3FN	44.5	89
V02474	B-G3FN/PL	30.5	61
V02446	G3PL/FN	44.5	89
V02471	B-G3PL/FN	30.5	61

2.1. Gas connection

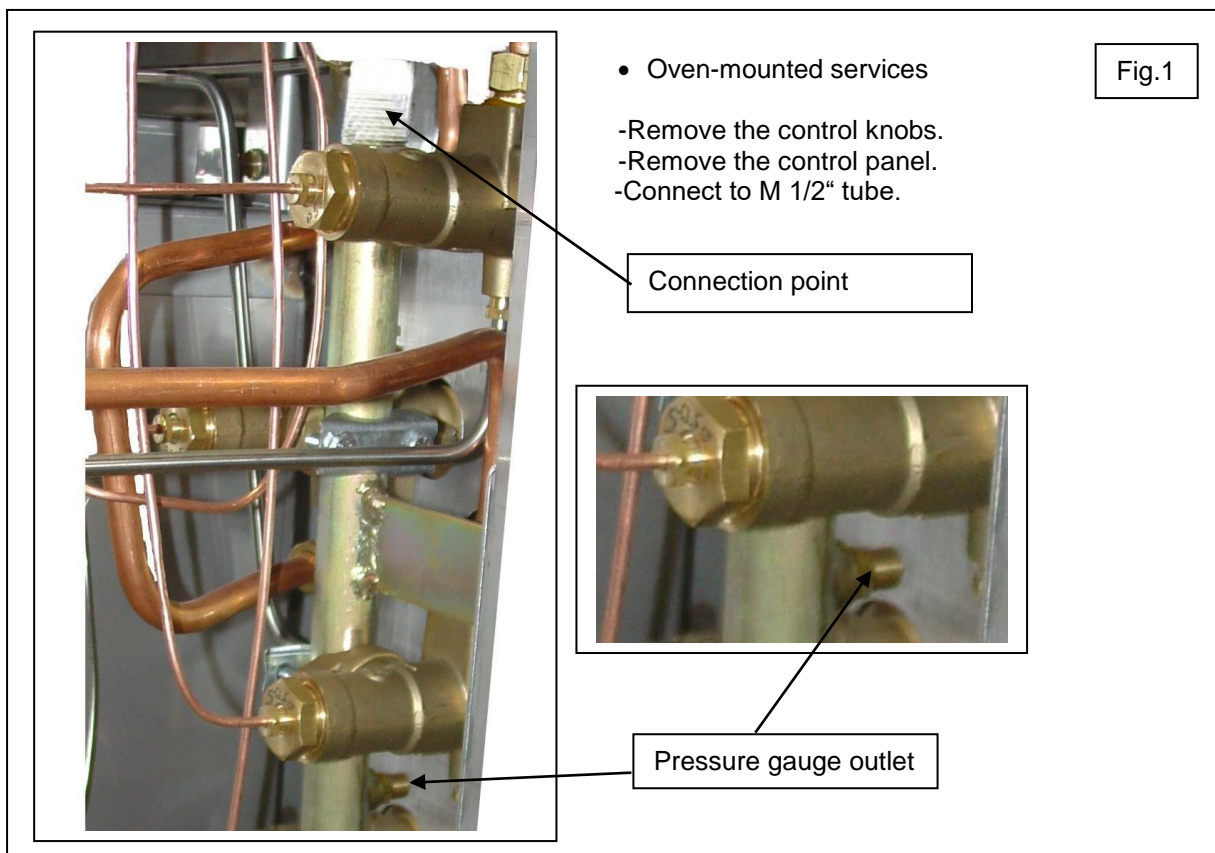

Gas-powered single unit

G3FN/PL-B-G3FN/PL- G3PL/FN-B-G3PL/FN

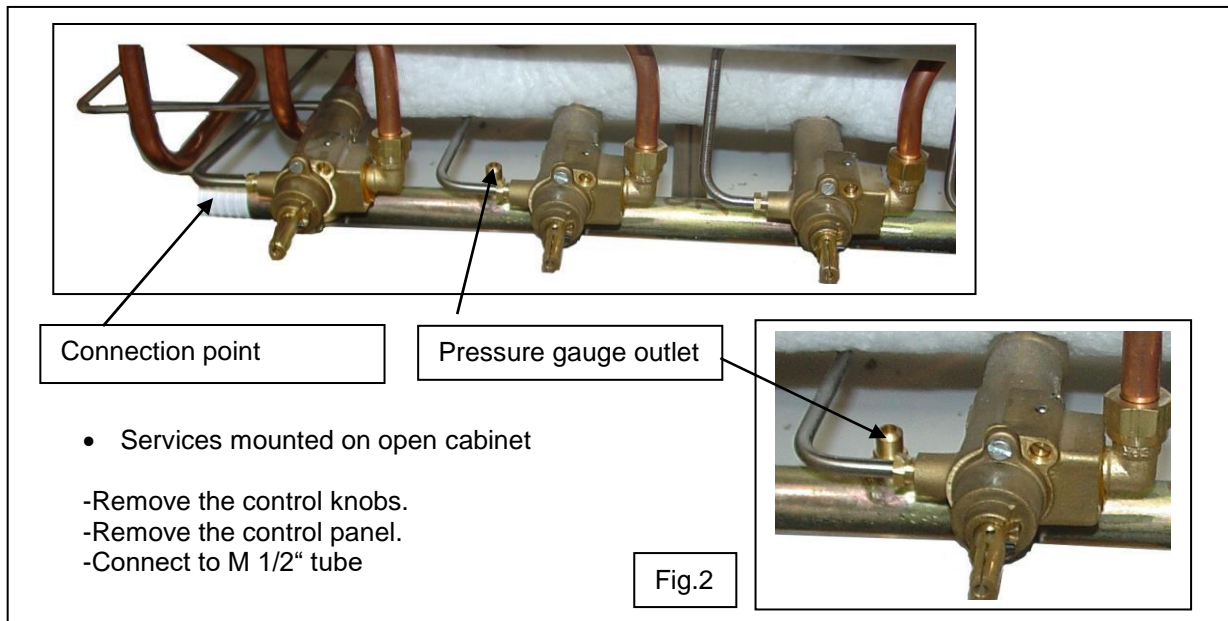

2.2. Checks and inspections before gas connection:

- **Points to be checked and inspected:**

- The tightness of the circuit up to the tap.
- Check the gas pressure of the appliance during operation. Pressure measurement procedure.

- Remove the control knobs.
- Remove the control panel.
- Connect the pressure gauge to the pressure gauge outlet located on the manifold. (see figs.1-2 on page 6)
- Turn on the appliance, at max. output)
- Check your readings (see Tables A-C)

Note: (All appliances connected to the same gas pipeline should be in operation for this check)

- Check flame pattern and colour is correct.
- Low output (see page 11)
- Check the correct operation of the appliance and the safety components.

3. Adapting the appliance to different types of gas

In case of gas change at the installation: After changing injectors, check the tightness of the gas circuit at the injector/injector holder connection point.

3.1. Injector changes and air adjustments

Refer to tables in § 3.2. depending on the burner. (see figs.1 and 2 on page 8)

- For the choice of diameter depending on the gas in the connected network.
- To view the air adjustment dimension 'd'.

- **Injector changes and air adjustments**

Gas-powered single unit

G3FN/PL-B-G3FN/PL- G3PL/FN-B-G3PL/FN

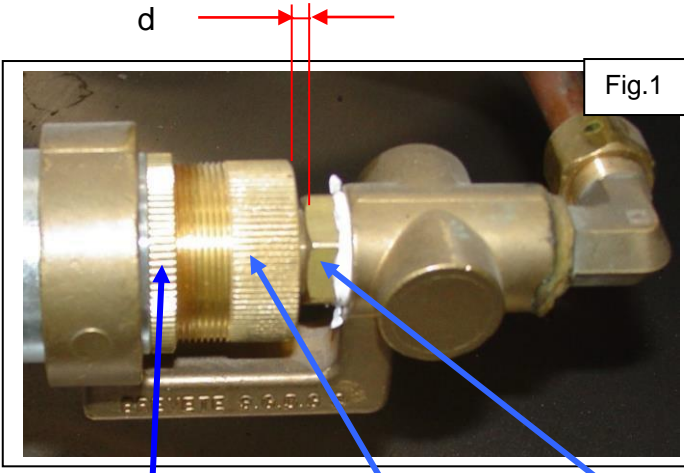

Fig.1

Nut

Air sleeve

Injector

d

- Open burners/Solid
 - Remove the pan supports, Then, to access the Venturi, remove the spillage tray.
 - The air ring and the injector are now accessible
 - Release the air sleeve (nut/sleeve)
 - Change the injector (17 mm ring spanner) See Table A § 3.2.
 - Set the distance 'd', re-lock

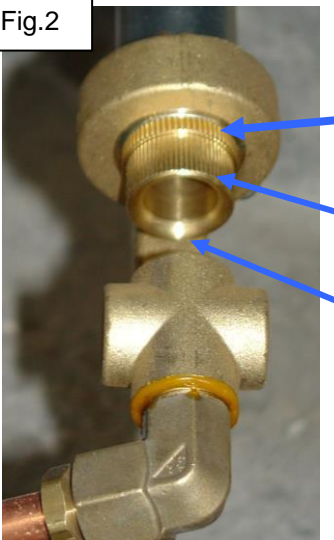

Fig.2

Nut

Air sleeve

Injector

- Oven: G3FN/PL-G3PL/FN
 - Remove the oven bottom, The air ring and the injector are now accessible. Release the air ring and move it backwards to access the injector.
 - Change the injector (17 mm ring spanner). See Table C in § 3.2.
 - Adjust the distance 'd' (Figure 2), re-lock (nut/sleeve), seal in position after adjustment.

Gas-powered single unit G3FN/PL-B-G3FN/PL- G3PL/FN-B-G3PL/FN

- Pilot light injector changes and air adjustments Solid top/Oven

a1

Open-end spanner '10'

Open-end spanner '12'

Open-end spanner '6'

a2

Y thread nut

Pilot light injector

a3

Pilot light air sleeve

Thermocouple

Ignition spark plug

Pilot light gas connection

Gas inlet

- Procedure

Remove the solid top and then the earth. (For the oven, remove the oven bottom.) Unscrew the pilot light bracket.

Unscrew the pilot gas connection.

Unscrew Y thread nut using an open-end spanner '12' (Figs. a1 and a2)

To replace the injector see Table D. To adjust the air sleeve (Fig.a3) see Table D in § 3.2.

!

After every injector change and air adjustment, check the tightness of the circuit and that the pilot light is functioning correctly.

Gas-powered single unit

G3FN/PL-B-G3FN/PL- G3PL/FN-B-G3PL/FN

3.2. Gas settings tables

Volcano burner				Table A
Air	Gas type under nominal pressure	Marker engraved on the injector	Air adjustment d (mm) *2	Nominal heat output kW *1
1	G20: Pn = 20 mbar	240	3	10
2	G 25: Pn = 20 mbar	250		
3	G 25: Pn = 25 mbar	240		
4	G 30: Pn = 29 mbar	150	Max.	
5	G 30: Pn = 50 mbar	135	Max.	
6	G 31: Pn = 37 mbar	150	Max.	
7	G 31: Pn = 50 mbar	150	2	
8	G 110: Pn = 8 mbar			
9	G 120: Pn = 8 mbar			

- 1 measured power on lower calorific value of gas (HI) for 1 burner.
- 2 Primary air adjustment measured as shown in Figure 1

Oven burner				Table C
Adjustment	Gas type under nominal pressure	Marker engraved on the injector	Air adjustment d (mm) *2	Nominal heat output kW *1
1	G20: Pn = 20 mbar	280	2	14
2	G 25: Pn = 20 mbar			
3	G 25: Pn = 25 mbar			
4	G 30: Pn = 29 mbar	190	3	
5	G 30: Pn = 50 mbar			
6	G 31: Pn = 37 mbar			
7	G 31: Pn = 50 mbar			

- 1 Measured power on lower calorific value of gas (HI)
- 2 Primary air adjustment measured as shown in Figure 1

Solid top burner				Table F
Adjustment	Gas type under nominal pressure	Marker engraved on the injector	Air adjustment d1/d (mm) *2	Nominal heat output kW* 1
1	G20: Pn = 20 mbar	240	Max.	10.5
2	G 25: Pn = 20 mbar			
3	G 25: Pn = 25 mbar			
4	G 30: Pn = 29 mbar	160	Max.	
5	G 30: Pn = 50 mbar			
6	G 31: Pn = 37 mbar			
7	G 31: Pn = 50 mbar			

- Pilot lights

Oven + Solid top				Table D
Adjustment	Gas type under nominal pressure	Marker engraved on the injector	Air adjustment d1/d (mm) *2	
1	G 20: Pn = 20 mbar	40	none	
2	G 25: Pn = 20 mbar			
3	G 25: Pn = 25 mbar			
4	G 30: Pn = 29 mbar	20	none	
5	G 30: Pn = 50 mbar			
6	G 31: Pn = 37 mbar			
7	G 31: Pn = 50 mbar			
8	G 110: Pn = 8 mbar			

Volcano burner		Table E
Adjustment	Gas type under nominal pressure	Marker engraved on the injector
1	G 20: Pn = 20 mbar	35
2	G 25: Pn = 20 mbar	
3	G 25: Pn = 25 mbar	
4	G 30: Pn = 29 mbar	22
5	G 30: Pn = 50 mbar	
6	G 31: Pn = 37 mbar	
7	G 31: Pn = 50 mbar	
8	G 110: Pn = 8 mbar	



Gas-powered single unit

G3FN/PL-B-G3FN/PL- G3PL/FN-B-G3PL/FN

3.3. Adjustment of low output

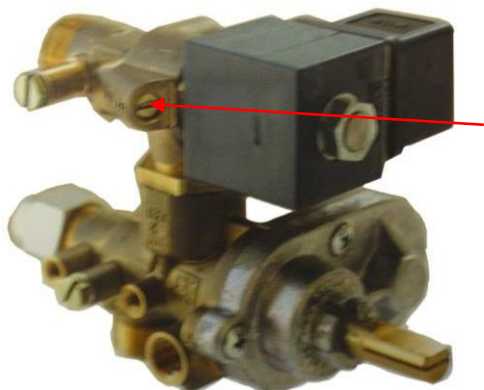

This is where the low output of the burner is set. The setting may only be modified by qualified personnel. Incorrect adjustment would have serious consequences, especially if they are too loose as this would eliminate the low output.

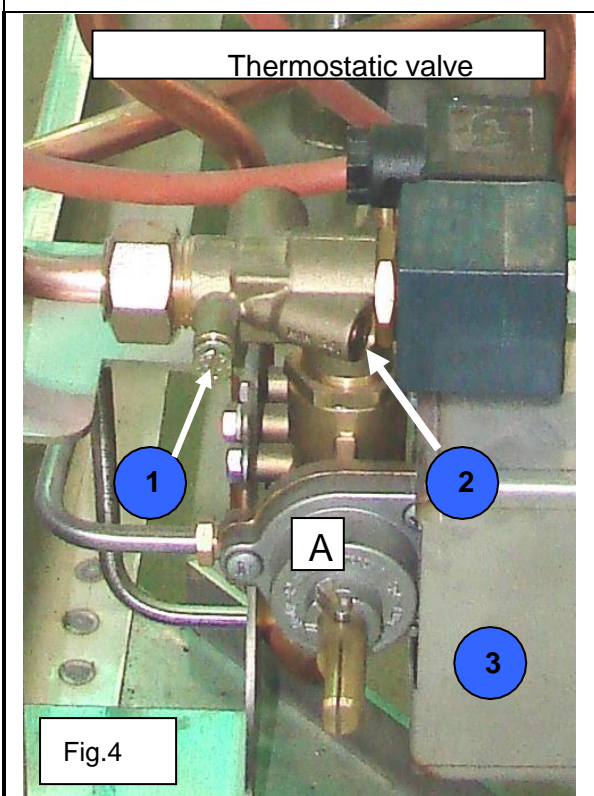
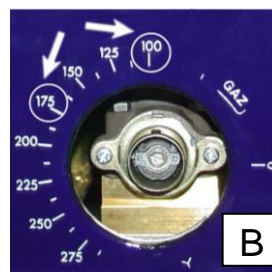

Fig.4



. Operate quickly before the thermostat reacts and the burner returns to max. output.
 Note: The flames are reduced to $\frac{1}{4}$ of their sizes in maximum position. The burner must not go out when switching from the max. position to the min. position.

- 1) Pressure gauge outlet.
- 2) Min. output screw
- 3) Thermostat.

- Procedure for adjusting the oven's low output. Remove the control knobs. Remove the control cover. Refit the control knob to the gas tap (A)
 Light the burner, preheat the $\sim \frac{1}{4}$ of an hour with the door closed. (Thermostatic valve 175°. Then switch to 100° position. Fig.B)

Tighten the screw (2) to reduce the burner flame and loosen it to increase it.
 The pressure can be measured at the pressure gauge outlet (1). (Fig.4)

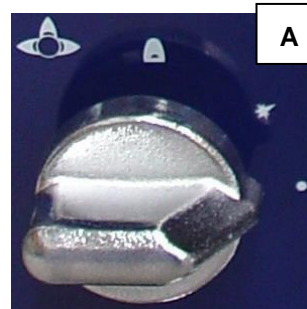

Gas-powered single unit

G3FN/PL-B-G3FN/PL- G3PL/FN-B-G3PL/FN

MANETTE EN POSITION RALENTI

VIS DE RALENTI



- Procedure for setting the low output of open burners.

Remove the control knob. Remove the control panel. (See § 2.1. Gas connections). Reposition the control knob.

Switch on the appliance. (see user section § 2.) Put in the low output position (Fig.3)

Turn the low output adjustment screw.

Note: The burner must not go out when changing from maximum output to minimum output. See low output adjustment



= Small flame or slow

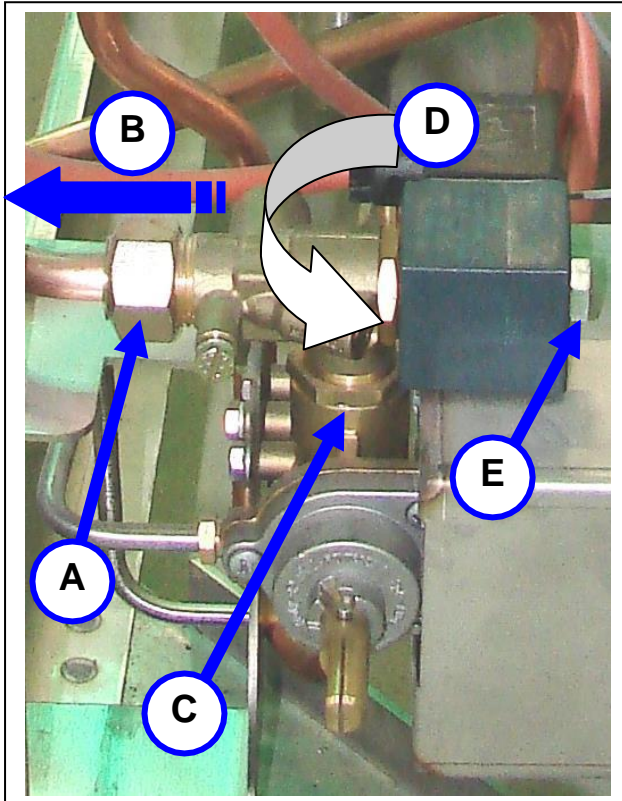

- Procedure for changing the solenoid valve.
(A) unscrew the nut and then lightly pull the copper (B) to the left. Loosen nut (C) then rotate assembly (D) and unscrew nut (E) to remove solenoid valve.

Gas-powered single unit

G3FN/PL-B-G3FN/PL- G3PL/FN-B-G3PL/FN

✓ ELECTRICAL PART

Warning

The appliance must be earthed.
It is dangerous to put the appliance into service without connecting it to earth.
Our liability cannot be incurred in the event of accidents resulting from non-existent or incorrect earthing.



- **Fixed and mobile appliance:**

Ensure that the user's fixed installation has an all-pole circuit breaker with point gap of 3.5mm in compliance with standard EN 60335-1 of May 2003.

- **Mobile appliance:**

The appliance is connected by a cable with a socket plug suitable for the power. This socket must be accessible at all times.



- **CAUTION:**

Use standard cable (245 IEC 57 or 245 IEC 66) or other cables with the same characteristics.

4. Checks and inspections before electrical connection

All the checks and inspections below are carried out when the appliance is switched off and cold.

- **Points to be checked and inspected:**

Before switching on the appliance, check:



- That the electrical voltage of the supply is compatible with the voltage and wattage of the appliance (see § 5)
- that the cable is fixed correctly,
- that the appliance's connections are tight,
- that the cable section is compatible with the voltage of the appliance.

4.1. Electrical connection

- ELECTRIC IGNITION/SOLENOID VALVE OF WATER TANK (for FN)

-the appliance is delivered with a flexible high temperature cable.

The power cable is located at the bottom of the open cabinet. (V02474-V02471)

To access the oven's electrical ignition cable, remove the side panel. (V02472-V02446) Connect the appliance to the electricity supply.

Before remounting, check that the electrical insulation of the appliance is in good order (condition of

Gas-powered single unit

G3FN/PL-B-G3FN/PL- G3PL/FN-B-G3PL/FN

- Electric ignition options

V02472-V02446

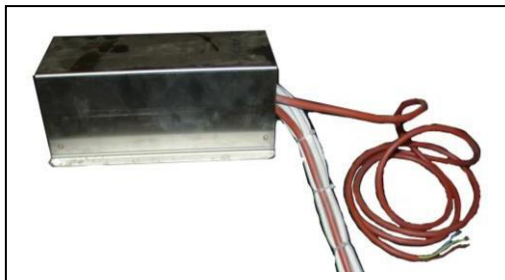
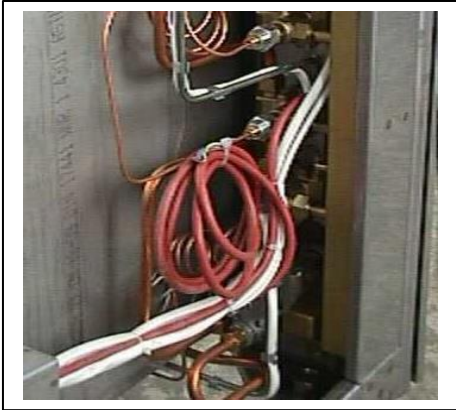

V02474-V02471

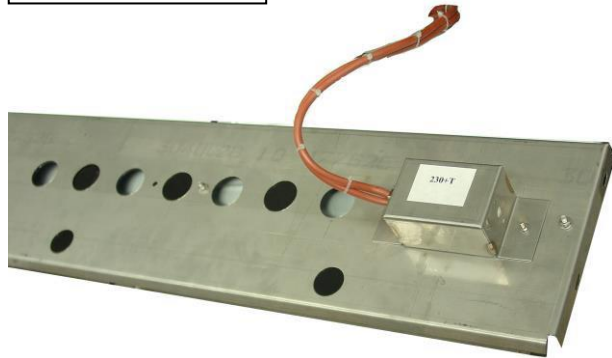

Gas-powered single unit

G3FN/PL-B-G3FN/PL- G3PL/FN-B-G3PL/FN

- Water tank options

V02472-V02446

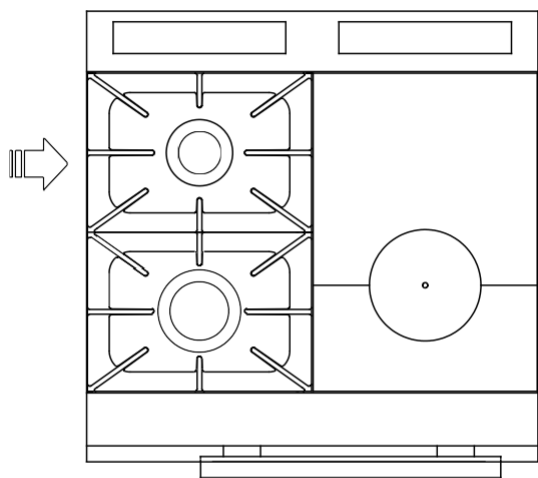

OPTION: WATER

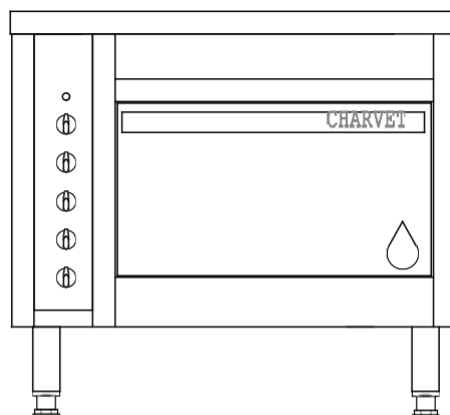

OPTION: Electric ignition + Water tank

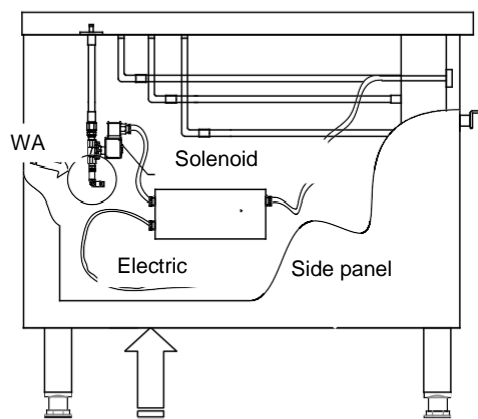
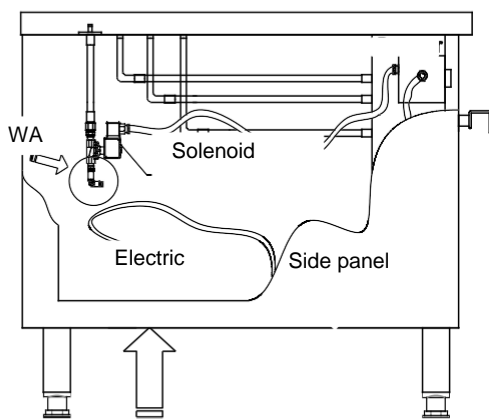

V02474-V02471

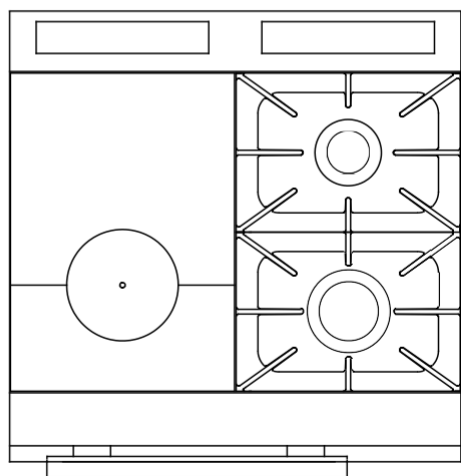

OPTION: Electric ignition + water tank
and Water tank only

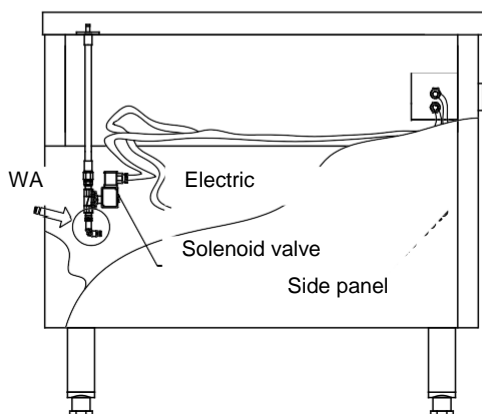

Gas-powered single unit

G3FN/PL-B-G3FN/PL- G3PL/FN-B-G3PL/FN

4. 2. Checks and inspections after electrical connection

- After connecting check:
 - That the appliance is correctly earthed, (see warnings)
 - The insulation of the electrical equipment,
 - That the appliance functions correctly (ignition, thermostat operation, etc.)

Starting up: (Refer to the user section on starting up the appliance)

5. Adapting the appliance to different network voltages.

Adaptations table

<i>Transformation on voltage</i> ↓	1~230V+T	3~230V+T	3~400V+T	3~400V+N+T
<i>Voltages of the delivered appliance</i>				
Electric ignition	X	A	C	A
1~230V+T				
Water tank	X	A	C	A
1~230V+T				
Electric ignition + Water tank	X	A	C	A
1~230V+T				

A → Coupling possible B → Consult us C → Coupling impossible D → Voltage not available

5.1. Wiring diagrams and the various appliance options: Table: Gas-powered single unit

<i>The various appliances</i> →	<i>G3FN/G3PL/FN</i>	<i>B-G3FN/B-G3PL/FN</i>
<i>The various electrical options.</i>		
Electric ignition ↓	1	1
Voltage	1~230V+ T	1~230V+ T
Wiring diagram	SE001/00	SE001/00
Water tank	1	1
Voltage	3	3
Wiring diagram	SE0099/00	SE0099/00
Ignition + Water tank	1	1
Voltage	3	3
Wiring diagram	2	2

1 → Option possible 2 → Option not available 3 → Option, please consult us



Gas-powered single unit

G3FN/PL-B-G3FN/PL- G3PL/FN-B-G3PL/FN

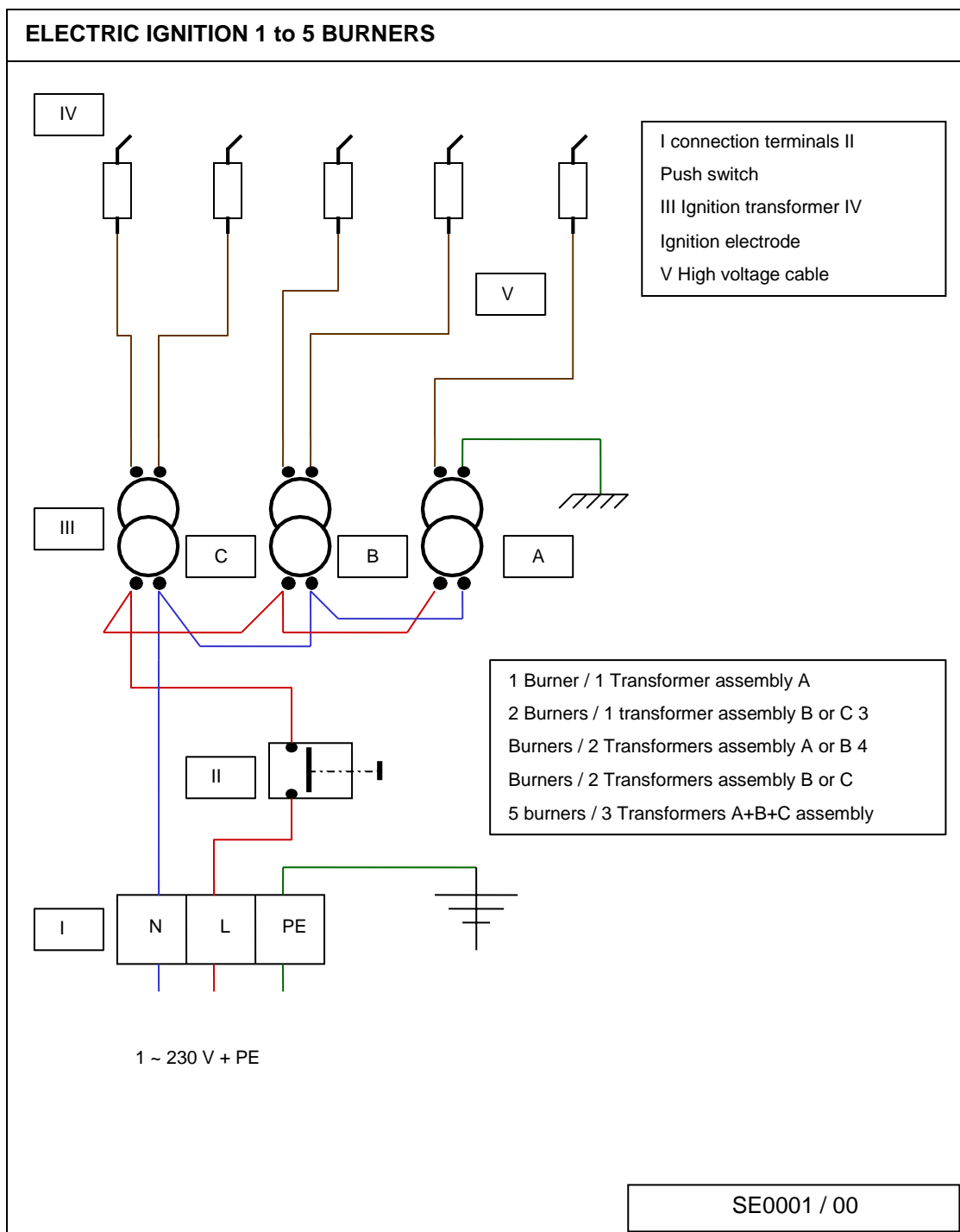

Gas-powered single unit

G3FN/PL-B-G3FN/PL- G3PL/FN-B-G3PL/FN

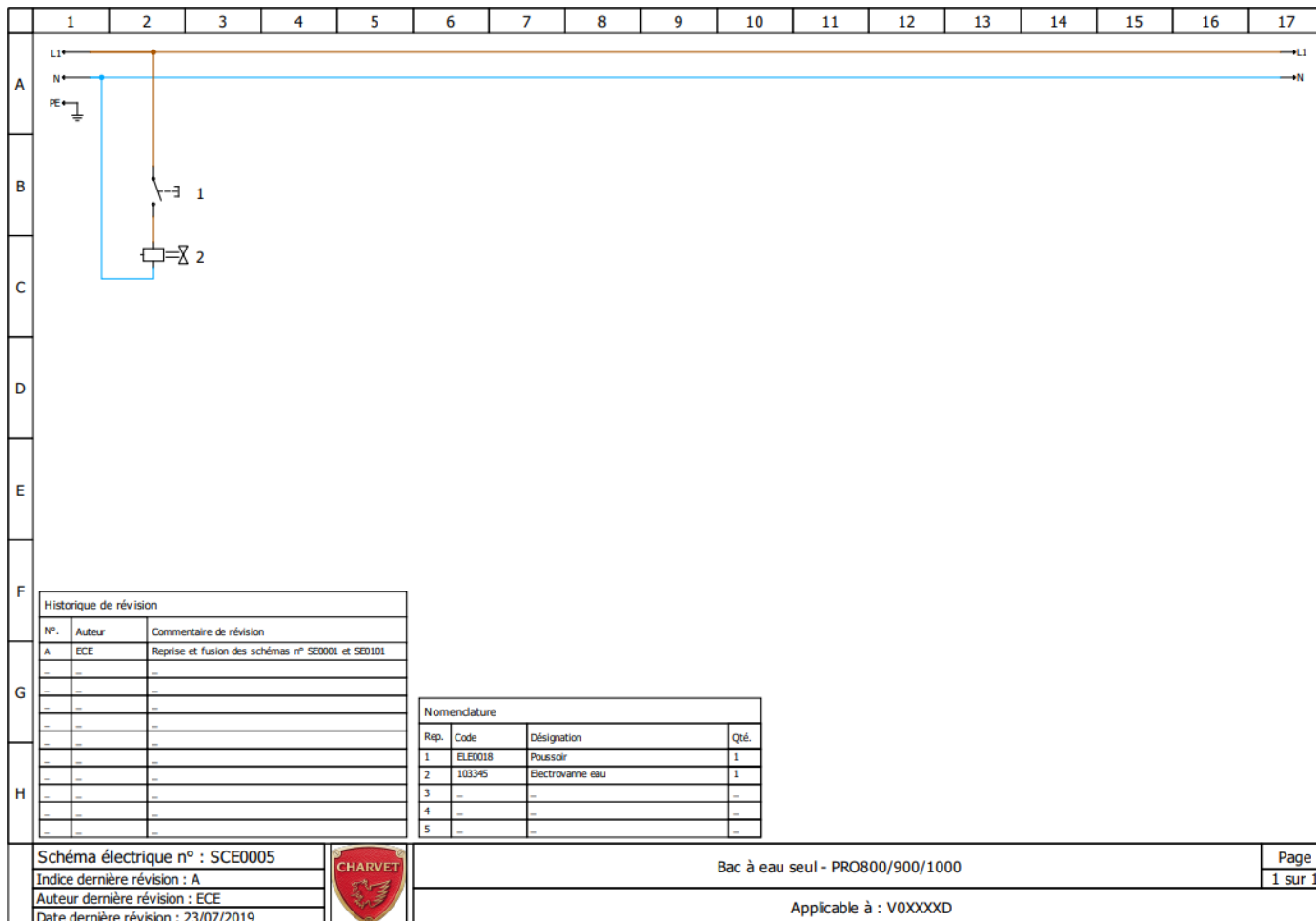

Gas-powered single unit

G3FN/PL-B-G3FN/PL- G3PL/FN-B-G3PL/FN

✓ WATER PART (WATER TANK OPTION)

6. Water connection :

Connection point on male end piece 6/8 of the solenoid valve. (see page 14 § 4.1.)

6.1. Checks and inspections after water connection

- After connecting check:
 - The watertightness of the water circuit.
 - The proper functioning of the water circuit.

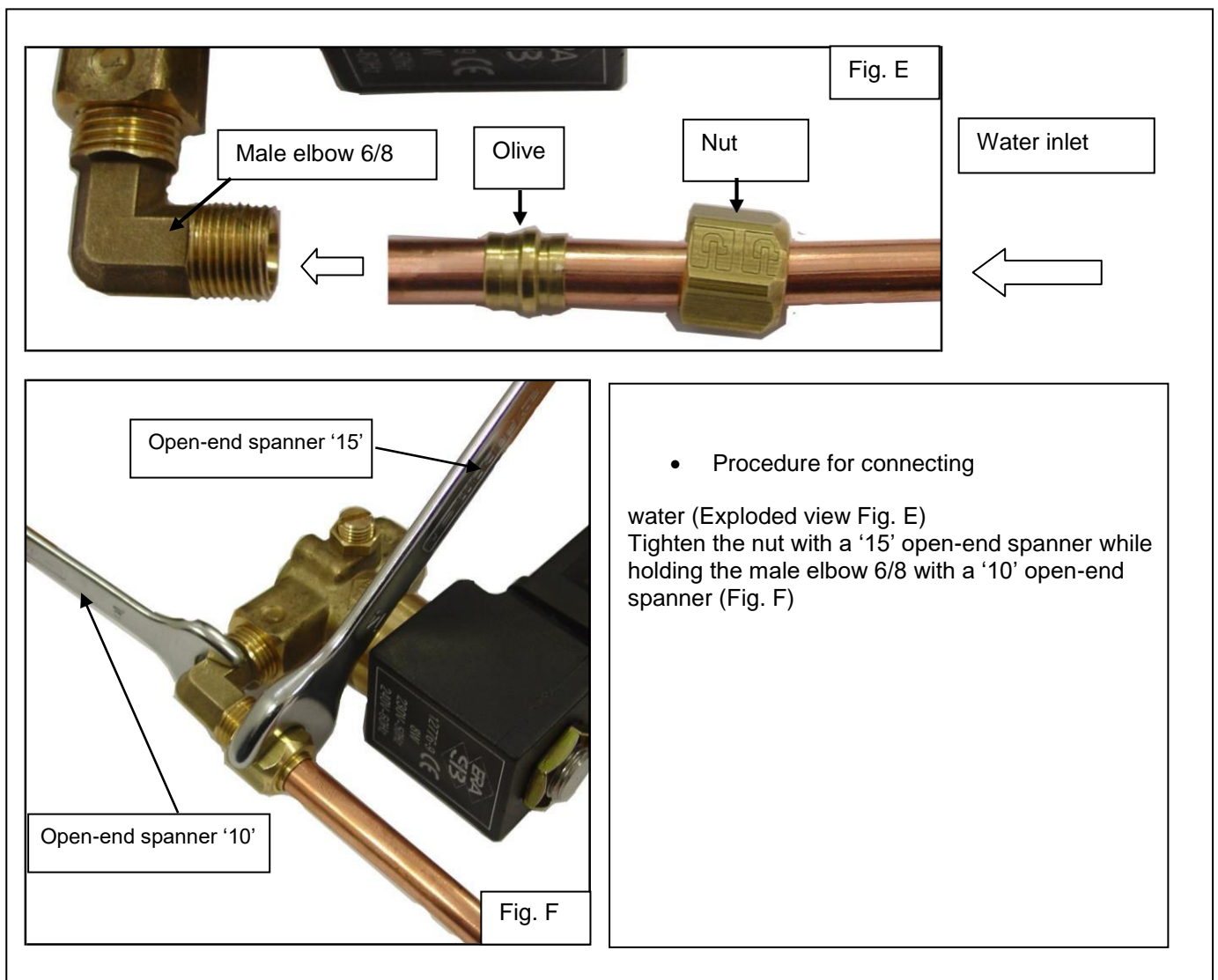

Gas-powered single unit

G3FN/PL-B-G3FN/PL- G3PL/FN-B-G3PL/FN

Description	Code	Photo	Description	Code	Photo
Injectors for the oven φ 1.90 Propane φ 2.80 Natural	00203A 00212A		Oven pilot light	07551A GN 07550A GP	
Volcano burner injectors φ 1.40 Propane φ 2.30 Natural	00198 A 00207A		Thermocouple	00290 A	
Solid top burner injectors φ 1.60 Propane φ 2.40 Natural	00200A 00208A		Water tank Solenoid valve	507649	
Pilot light injectors Oven Ø 0.20 propane Ø 0.40 natural	07357A 06430A		Ignition transformer	02161A	
Gas tap FOR Oven ON OVEN ON Open Cabinet	00503A 05226A 00502A		Ignition push-button	ELE0018	
Thermostatic valve for oven	00295A		Pilot light injector	08285A NG 08286A PG	
Volcano burner pilot light	08284A		Ignition spark plug	08287A	
Volcano burner Cap only	08022A 08494 A		PCF burner Ø120	00123A	

Gas-powered single unit G3FN/PL-B-G3FN/PL- G3PL/FN-B-G3PL/FN

Series: Pro 1000 with 'volcano' burners



- V02472 Pro 1000 G3FN/PL** Single unit 2FN/1PL/ Gas oven
- V02474 Pro 1000 B-G3FN/PL** Single unit 2FN/1PL/ Open cabinet
- V02446 Pro 1000 G3PL/FN** Single unit 1PL/2FN/ Gas oven
- V02471 Pro 1000 B-G3PL/FN** Single unit 1PL/2FN/ Open cabinet

Option: Electric ignition
Water tank

User manual



Gas-powered single unit

G3FN/PL-B-G3FN/PL- G3PL/FN-B-G3PL/FN

'Compliance with French Decree No. 2005-829 of 20 July 2005.' **Exclusively for France**

A - In accordance with Article 18 of Decree No. 2005-829 of 20 July 2005 on the disposal of waste electrical and electronic equipment, the Paul CHARVET company takes responsibility for the financing and organisation of the disposal of its waste. As such, the Paul CHARVET company resumes full ownership of the electrical and electronic equipment at the end of its life. The equipment should be palletised and ready for loading in a place that is accessible by the carrier. Except in exceptional circumstances, the equipment shall in no case have been dismantled, even partially, otherwise CHARVET reserves the right to re-invoice the costs of processing and taking responsibility for the equipment.

B- How WEEE is disposed of:

The terms and conditions of disposal are covered by the SYNEG/RECYSTEM-PRO agreement, which states that: "In order to fulfil their obligations, the producers of electrical and electronic equipment for large kitchens grouped within the SYNEG, have implemented arrangements for the collection and processing/recycling of WEEE in accordance with the provisions of the decree.

Materials or substances harmful to the environment (such as refrigerants or foams) are extracted or separated. The metal fractions (stainless steel, zinc, copper, etc.) are crushed and transported to refiners for reuse. Therefore, when you need to have electrical equipment collected by a SYNEG professional kitchen equipment manufacturer, you must contact RECYSTEM-PRO, the operator chosen for the management of WEEE

- ↳ at this telephone number: 01 45 01 71 43.
- ↳ or at the following e-mail address: synegdeee@recystempro.com

You will then be sent a collection request sheet which will contain the following elements:

- name of the producer of the equipment
- type of equipment
- estimated weight
- place of collection
- name and contact details of the installer
- invoicing address

After verification with the producer and obtaining its agreement, RECYSTEM-PRO will proceed with the collection."

"This device complies with the 2009/142 (Declaration of conformity to type) directive"



Gas-powered single unit

G3FN/PL-B-G3FN/PL- G3PL/FN-B-G3PL/FN

INTRODUCTION:

- A) Our appliances are intended for professional use and should be used by qualified personnel.
- B) They must be installed in accordance with the regulations and standards in force in the country of installation, in a sufficiently ventilated room with an extractor hood.
- C) The appliance may be attached to others or placed against fire-proof walls, but must not, under any circumstances, be located within 10 cm of any combustible element.
- D) Any modifications to existing equipment or any new installations must be carried out by a qualified installer.
- E) **WARRANTY:** *The warranty is part of the sale contract. For any work to be carried out under the warranty, please contact an authorised dealer. This warranty does not cover any damages due to faulty installation, misuse or inadequate maintenance.*

1. STARTING UP FOR THE FIRST TIME:

- a) Prior to starting up for the first time, it is advisable to clean the appliance in order to eliminate all dust or impurities that have accumulated during storage.
- b) Remove all protective plastic wrapping from the stainless steel parts.
- c) Make sure that all the control components are functional, then open the gas block valve.

☞ Screen print legend:

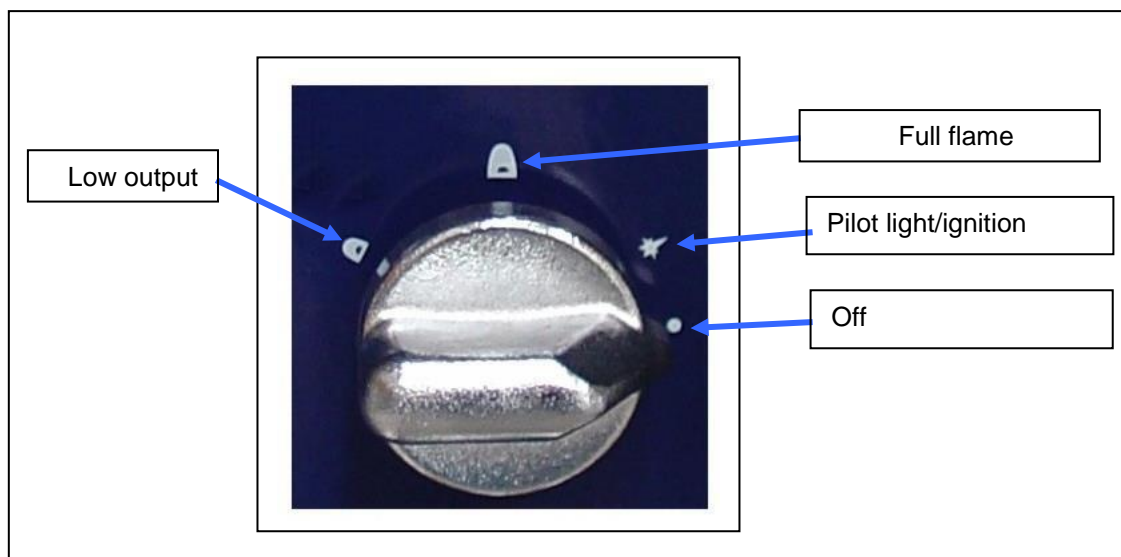

Warnings:

Gas-powered single unit

G3FN/PL-B-G3FN/PL- G3PL/FN-B-G3PL/FN



Before each use, check that the burner cap is fully seated in the recess.
(See procedure)

Caution: Do not drop the burner cap as it can become damaged and its operation will be faulty.

- **Procedure:**

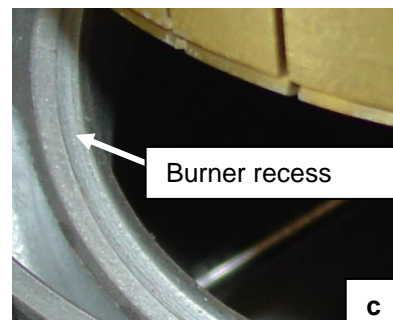

- **Open burners**

Remove the cast iron pan support (10.6kg) (Fig.a)

Position the burner cap (Figs.b,c) in its housing. (see diagrams d,e)

Then check if it is correctly in place, by pushing it from left to right, (Fig.f). It must not come out of the recess.

If the burner cap is incorrectly positioned in its housing it will become damaged and its operation will be faulty.

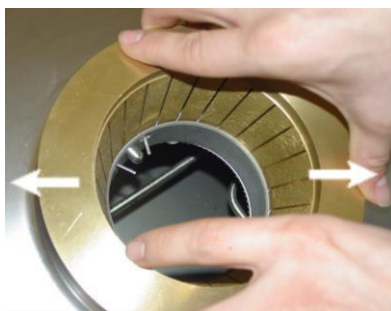
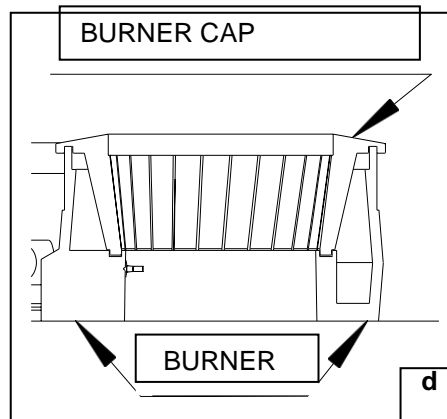

Burner recess or housing

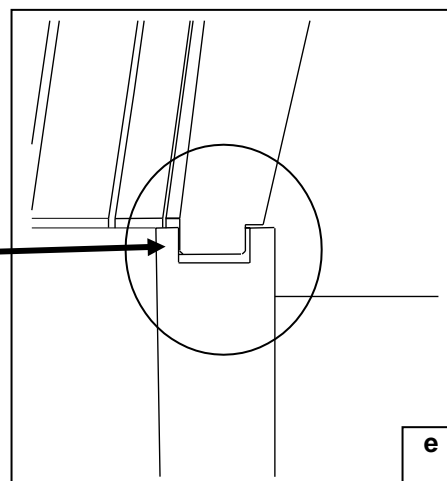

Gas-powered single unit

G3FN/PL-B-G3FN/PL- G3PL/FN-B-G3PL/FN

2. STARTING UP

General: Each burner is equipped with a thermocouple safety system and a permanent pilot light.

2.1. Open burners/Solid top

Remove the cover from the solid top. (Simmer plate). Push and turn the burner control knob anti-clockwise until it is at the pilot light position.

Press the knob down fully and at the same time present a flame to the pilot light holes or use the ignition push-button for appliances equipped with **the electric ignition option.**

Keep the control knob pressed down for a few seconds (approximately 5 to 20 seconds) before releasing it.

The pilot light should remain lit. If this does not work, repeat the operation.

With the pilot light on, turn the control knob anti-clockwise until it is at the 'full flame' position (see screen print legend), the burner operates at its nominal power.

Turning the knob to the next position (pointing to the small flame) gives a lower output for simmering.

Refit the solid top (Simmering plate) cover.

2.2. Oven

Check that the ignition hole for the oven bottom (oblong hole) is located at the front left of the oven, i.e. above the pilot light.

Push and turn the control knob corresponding to the burner (Figure 3, Item G) anti-clockwise until the knob is pointing to the spark.

Press the knob down fully and at the same time introduce a flame through the hole in the oven bottom near the pilot light holes or use the ignition push-button for appliances equipped with **the electric ignition option.**

Keep the control knob pressed down for a few seconds (approximately 5 to 20 seconds) before releasing it.

The pilot light must remain lit. If this does not work, repeat the operation.

With the pilot light on, turn the control knob anti-clockwise to the 'full output' position (see screen print legend). Turn the thermostat control knob (Figure 3, Item H) to the desired temperature, the oven burner comes on at full power.

Close the oven door.

Caution:

When opening the oven door during 'wet' cooking, beware of escaping steam, there is a risk of burning.

The oven's walls and door may be very hot after intensive or prolonged use, always use the handle only when opening and closing the door and stand well back.

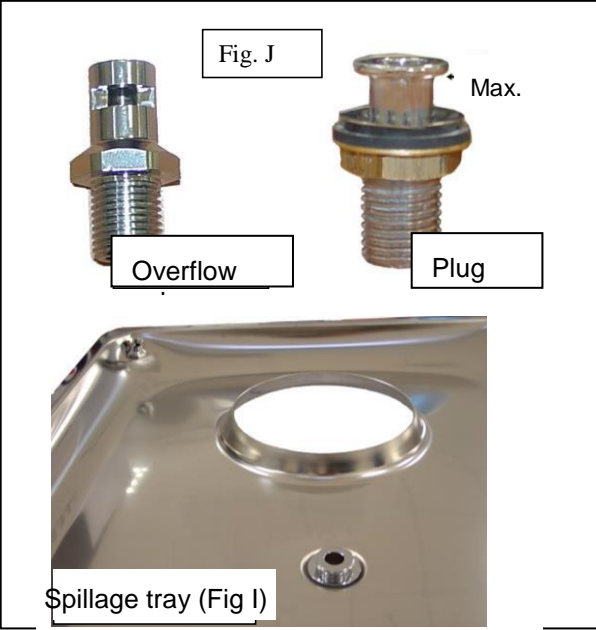

Figure 3

Gas-powered single unit

G3FN/PL-B-G3FN/PL- G3PL/FN-B-G3PL/FN

2.3. Using the water tank



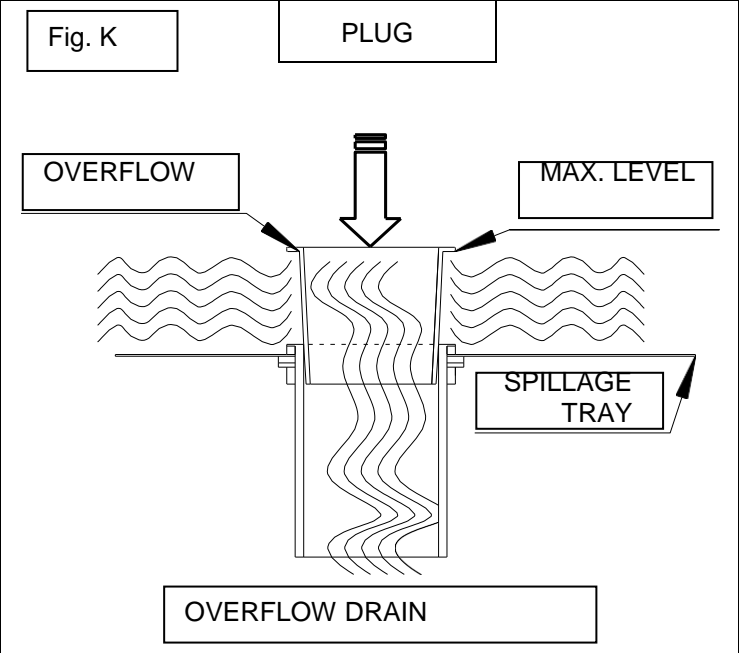

Water tank only or with Electric ignition only	Ignition + water tank
--	--------------------------

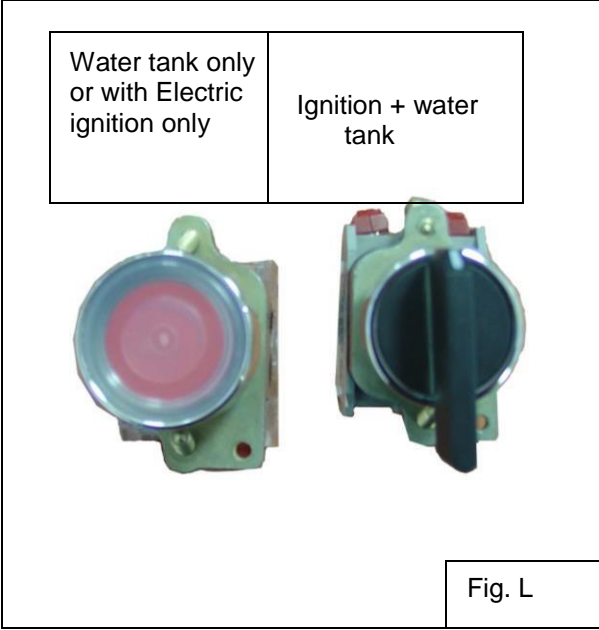

- Checks before using the water tank

Check that the plug is correctly in position in the middle of the spillage tray. (Fig.I) and (Fig.J).

- Procedure for use

Operate the push button or switch (Fig.L) then fill up to the maximum level of the plug. (Fig.K)

Note 1: To drain remove the overflow.

Note 2: After switching on the water tank, visually check the watertightness of the water connection circuit.

3. SWITCHING OFF

Return the control knobs of the various taps to the position ● = Off. At the end of the day, turn off the gas valve and the electricity supply.

4. MAINTENANCE

Wait until the elements near the burners have cooled down.

Gas-powered single unit

G3FN/PL-B-G3FN/PL- G3PL/FN-B-G3PL/FN

4.1. Cleaning the stainless steel surfaces:

- a) Switch off the appliance. After each service and before each cleaning operation, we advise you to disconnect the appliance from the mains (gas and electric supplies).
- b) Wash with a sponge in soapy water (or any other neutral cleaning product). *Do not use bleach or any acid if heavily diluted.*

If necessary, use a scouring sponge for the tops, taking care to always rub **in the direction of polishing**.
Note: Do not lose the plug, after each cleaning, put it back into position.

Caution: Dry the open burner pan supports thoroughly after cleaning to avoid any risk of rust forming and then wipe with an oily cloth after drying.

Caution: The solid top is cleaned with a Tampico brush or a wooden spatula. Never clean a cast iron solid top by deglazing.

Dry the solid top well, then wipe with an oily cloth to prevent rust forming.

4.2. Cleaning the oven

In order to avoid the release of fumes due to stains and residues of fats and food, frequent cleaning of all the oven walls is recommended.

The base can be removed so that it and the burner housing can be cleaned. (See § 4.2.1). The shelf runners can also be taken out for hand washing. (See § 4.2.1)

The oven is cleaned with a moist sponge and a neutral detergent. Rinse after cleaning, dry all the parts. Refit the parts in the reverse order from when they were removed.

This appliance must not be cleaned by means of water spray or water jets under pressure. Check that the appliance is disconnected at the mains.

Table provided as a guide only:

Description	Part weight in kg
<u>Solid top*</u>	45 kg
<u>Oven base*</u>	23 kg
<u>Cast iron pan support*</u>	10.6 kg
<u>Oven shelf</u>	3.2 kg
<u>Spillage tray</u>	3 kg
<u>Shelf runner</u>	2.6 kg

*Note: Handle the parts carefully, for your own safety.

Gas-powered single unit

G3FN/PL-B-G3FN/PL- G3PL/FN-B-G3PL/FN

Cleaning the volcano burner caps:

Periodically clean the caps to prevent their corrosion.

You can clean the caps with a cloth dampened with water and soda detergent (1/2 glass of detergent per litre).

You can also clean the caps with white vinegar. Leave it to work for 2 hours.
(Never add salt to the white vinegar).

Do not forget to rinse thoroughly, even between the slots in the burner cap.
Failure to completely rinse will result in a green flame and damage to the burner cap.

Warning:

"When the cooking water of seafood or sauerkraut overflows, this increases wear of the brass burner cap. We recommend that, after each intensive use and as soon as the burner has cooled down, it should be rinsed with plenty of fresh water. These parts that are in contact with the flame are considered to be wearing parts and do not fall within the scope of the warranty." Rinsing will not stop them from wearing but may delay it."



Gas-powered single unit

G3FN/PL-B-G3FN/PL- G3PL/FN-B-G3PL/FN

4.2.1. Maintenance of the base, shelves and shelf runners



- Procedure for removing and refitting the base and the shelf runners

- A) Pull the shelf towards you.
- B) Use the oblong hole to pull out the base.

The base is a heavy component, please handle it with care. Base weight = 23 kg

- C) 1 and 2: Lift the shelf runner and then pull it to the left (3): Pull the shelf runner towards you.

Gas-powered single unit

G3FN/PL-B-G3FN/PL- G3PL/FN-B-G3PL/FN

For best results, have your equipment serviced and cleaned regularly, according to the intensity of its use, by a qualified installer.

Caution: Caution: Some parts of this appliance are factory-sealed by the manufacturer. In case of a fault, call a qualified installer.

<u>Problem</u>	<u>Probable causes</u>
No heat	Burner outlets, injectors, etc., clogged.
	Gas supply pressure incorrect.
	Incorrectly calibrated injectors.
	Flue gas outlets clogged (oven, solid top)
Oven temperature incorrect	Faulty thermostat.
Faulty ignition	Pilot light holes clogged.
	Thermocouple clogged (sensitive part).
	Difficulty activating the thermocouples, output from the pilot lights.
	Positioning of the pilot lights.
Faulty electric ignition (Optional).	Control knob not pushed in sufficiently.
	Position of the spark plug.

5. Table of possible problems.

Contact the installer to replace any faulty electric control components before further use.



Only a qualified electrician may replace the ignition transformers.



The manufacturer and the installer CANNOT BE HELD LIABLE if the user does not make a request for repairs due to these malfunctions.

Please RECORD the information on the DATA PLATE of your appliance below.



Gas-powered single unit

G3FN/PL-B-G3FN/PL- G3PL/FN-B-G3PL/FN

	CHARVET S.A. 38850 CHARAVINES
Réf.	<input style="width: 100%;" type="text"/>
Code:	<input style="width: 50%;" type="text"/> Type: <input style="width: 50%;" type="text"/>
N°FC:	<input style="width: 50%;" type="text"/> <input style="width: 50%;" type="text"/>
N°OF:	<input style="width: 50%;" type="text"/> Rep. <input style="width: 50%;" type="text"/>
Cat.	<input style="width: 100%;" type="text"/>
Gaz	<input style="width: 100%;" type="text"/>
P (mbar)	<input style="width: 100%;" type="text"/>
ΣQ_n (kW)	<input style="width: 100%;" type="text"/>
ΣV_n (m ³ /h)	<input style="width: 100%;" type="text"/>
ΣM_n (kg/h)	<input style="width: 100%;" type="text"/>
U	<input style="width: 20%;" type="text"/> V <input style="width: 20%;" type="text"/> Hz Ip <input style="width: 20%;" type="text"/>
P	<input style="width: 20%;" type="text"/> kW <input style="width: 20%;" type="text"/>
	<input style="width: 100%;" type="text"/>
MADE IN FRANCE	

This information will facilitate communication with your installer for maintenance and the supply of spare parts.

