

# Installation and Set Up Instructions For Electric Fryers

Description	PRO 800 series	PRO 900 series
E2FR1412	V02210	V02212
E2FR1618HR	V02211	V02213
½ E1FR1412	V01706	V01512
½ E1FR1618HR	V01708	V01513
½ R-E1FR1412	V01707	V01744
½ R-E1FR1618HR	V02426	V02428



**ELECTRIC FRYER ON CUPBOARD**  
*(not contractual photograph)*





## S U M M A R Y

<b>1. INSTALLATION .....</b>	<b>2</b>
<b>1.1. GENERAL POINTS.....</b>	<b>2</b>
<b>1.2. HANDLING.....</b>	<b>2</b>
<b>1.3. INSTALLATION .....</b>	<b>2</b>
<b>1.4. DATA PLATE.....</b>	<b>3</b>
<b>2. POWER CONNECTIONS .....</b>	<b>3</b>
<b>2.1. CHECKS BEFORE CONNECTION .....</b>	<b>4</b>
<b>2.2. CONNECTION .....</b>	<b>4</b>
<b>2.3. WIRING DIAGRAMS.....</b>	<b>4</b>
<b>2.4. HAND OVER.....</b>	<b>8</b>
<b>2.5. REACTIVATION OF THE HIGH LIMIT SAFETY THERMOSTAT .....</b>	<b>8</b>
<b>2.6. CHECKS AFTER CONNECTION .....</b>	<b>8</b>
<b>3. BASIC SPARE PARTS LIST .....</b>	<b>9</b>



## 1. INSTALLATION

### 1.1. General points

Installation must be undertaken in compliance with the following instructions and with local codes and bylaws. Ensure you have a suitable and sufficient risk assessment in place.

The user manual must be given to the user after installation.

### 1.2. Handling

It is imperative to leave the appliance on its wooden pallet for handling on site until the final installation.

Unpack and check the apparatus for damage upon receipt.

In case of damage, mark delivery note accordingly and immediately (within 48 hours) notify the carrier by registered mail with acknowledgement of receipt. Notify your installer.

### 1.3. Installation



**DO NOT INSTALL A FRYER TOO CLOSE TO AN APPLIANCE WITH OPEN BURNERS OR INSERT A WORKING TOP OF A LEAST 10 CM BETWEEN THE TWO APPLIANCES TO AVOID ALL RISK OF OIL SPLASHES ON OPEN BURNERS.**

This appliance must be installed under a suitable mechanical extraction hood, close to the electric supply.

If the apparatus is to be installed against a wall or partition, near a piece of furniture or decorative borders, it is recommended that these are made of fireproof material.

If this is not the case, they must be protected by an approved fireproof, insulating material. All local fire regulations must be adhered to. If in doubt fireproof construction of adjacent walls, distance to combustible material shall be no less than 10 cm.

Remove all plastic protection.

#### NOTICE





- **Fixed appliance:**  
Install the feet or the levelling studs (they are delivered in a box kept inside the appliance).  
Adjust height to level the unit to an horizontal working plan of 900 mm.  
Fix all independent half module against the wall.
  - **Mobile appliance :**  
Install the castors (they are delivered in a box kept inside the appliance).  
The castors with brakes must be locked when the appliance is being connected and during cooking times. Fix all independent half module against the wall.
- Any technical action on an apparatus must be undertaken by a qualified technician.  
The apparatus will have to be isolated from the electrical supply for the duration of the work.
- When the apparatus is ready for use ensure the users know how to use it properly (see users guide). Formerly give the person in charge all documentation needed.
- WARRANTY:** The warranty is specified on the conditions of sale and does not cover damage due to incorrect installation, misuse or inadequate maintenance.



### 1.4. Data plate

Each apparatus has its own data plate. Transfer all the information on the data plate to the part of the user instructions booklet reserved for it (see the last page). The data plate will ease the communication between you and your client for better service. See locations below:

		
<b>Appliances with open base</b>	<b>Bridge units</b>	<b>Appliances with gas oven</b>

## 2. POWER CONNECTIONS

Material, assembly and welding tools must be in compliance with the standard EN 45 204.

### NOTICE



**The apparatus must be earth wired.  
It is dangerous to connect the apparatus unless it is earthed.**

Use a standardized cable (245 IEC 57 or 245 IEC 66) or other approved cable with the same characteristics.  
Check that the electrical voltage of the supply is compatible with the voltage of the apparatus (see data plate).

**. Fixed appliance**  
The apparatus being connected to a cable fitted with an electrical plug, the socket should be equipped with an omnipolar circuit breaker with a cross section of 3.5 mm at least. All electrical equipment must be in compliance with the standard EN 60335.

**. Mobile appliance**  
The apparatus being connected to a cable fitted with an electrical plug, the socket should be accessible at all times.

**We cannot be held responsible for accidents due to non existent or incorrect earth link connection.**

## 2.1. Checks before connection



**All this operations are carried out when the apparatus is switched off and cold. Never use with empty tank. For trials without oil fill up the tank with water at the appropriate levels.**

Before connection, ensure that:

- The supply voltage is compatible with the voltage of the apparatus (see § 2.3),
- The cable is fixed properly,
- The connections are tight enough,
- The section of the cable is suitable for the power,
- The electrical equipment is properly insulated.

The apparatus is wired at the factory according to requirements notified at the time of order. For any change of voltage required during the lifetime of the apparatus consult the manufacturer.

Install a transformer between the electrical supply and the apparatus in case this latest is fitted with an electronic regulation and a melt cycle in single phase 230V + N or in 230V between the phases. This will create an artificial neutral point connected to earth ground.

## 2.2. Connection

- Dismantle the front control panel to reach the terminal box (fixed with clips),
- Thread cable through right hand side panel of the frame, enter terminal box through back opening,
- Connect supply cable to terminal by following diagrams below, making sure to follow instructions on the box,
- Before reassembling inspect all cables for damage.

TERMINAL BOX EFR 14/12

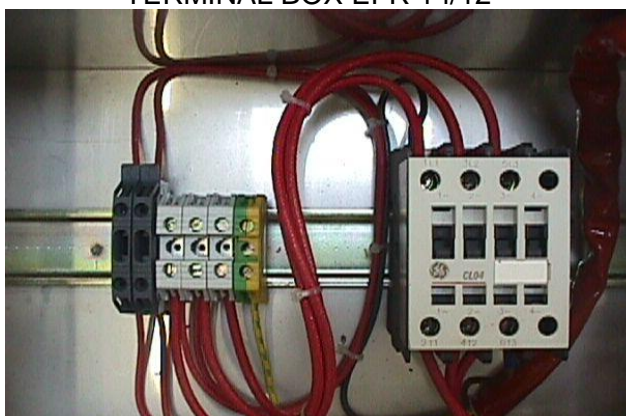

TERMINAL BOX EFR 16/18HR

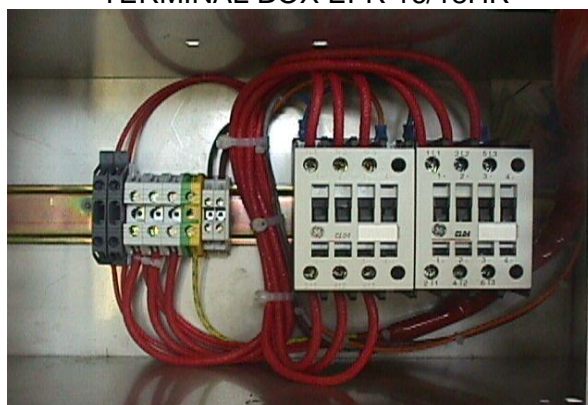

## 2.3. Wiring diagrams

Apparatus	Voltage	N° electrical diagram
EFR 14/12	3 ~ 400 V + PE	SE0009 / 00
EFR 16/18HR	3 ~ 400 V + PE	SE0010 / 00
EFR 16/18HR	3 ~ 400 V + PE	SE0026 / 00

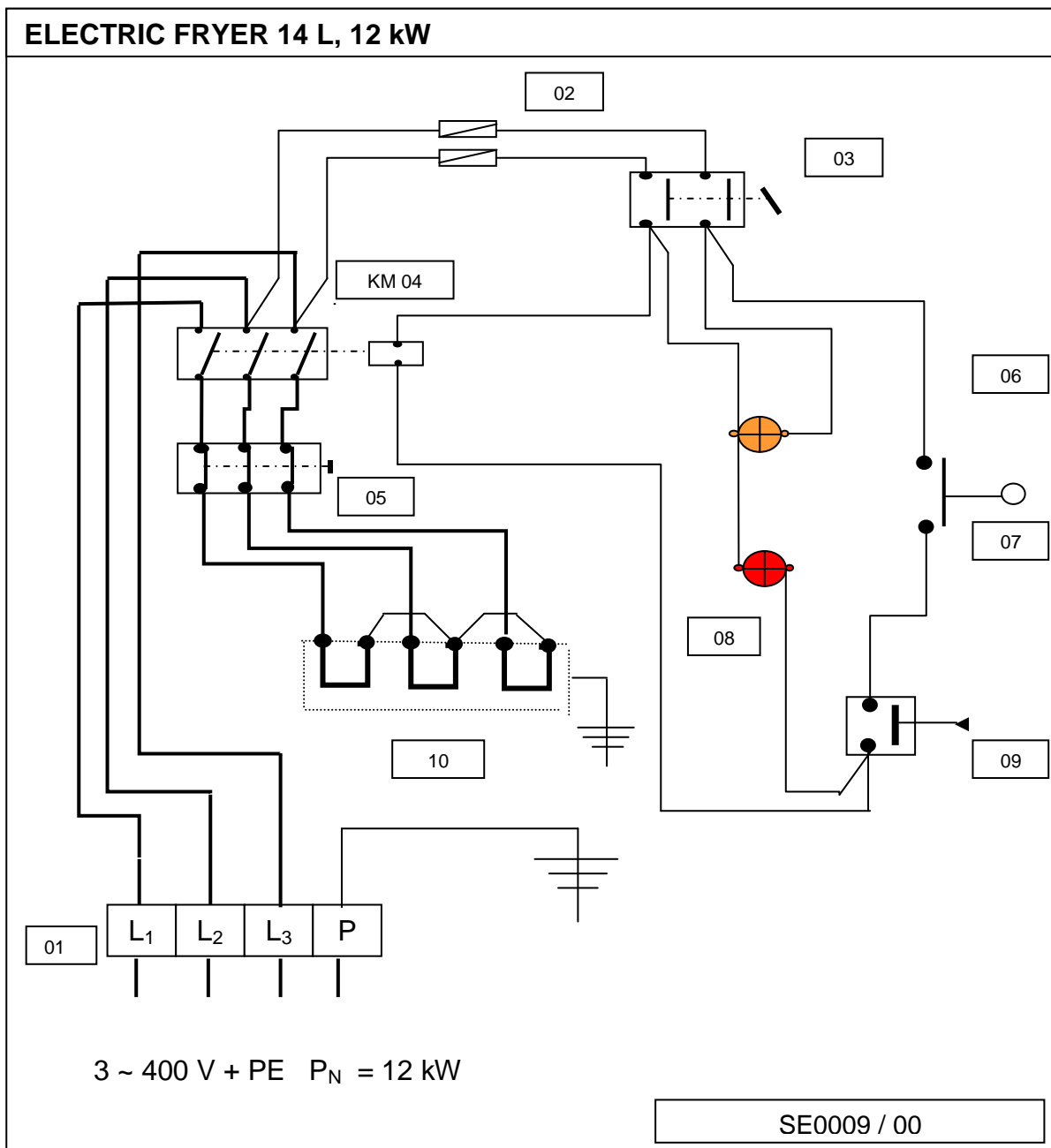

**NOMENCLATURE: ELECTRIC FRYER 14 L/12 kW (diagram: SE0009 / 00)**

Mark	Code No	Description	Quantity
01	02468A	10 A terminal box (brand: Viking)	3
01	03575A	10 A terminal box (brand: Viking)	1
02	02726A	5 mm x 20 mm fuse support	2
02	03413A	5 mm x 20 mm - 5 A fuse	2
03	02104A	Switch with handle	1
04	02200A	Contacteur 55 A 400 V	1
05	05996A	Safety thermostat	1
06	05075A	Yellow high temperature indicator	1
06/08	02142A	400 V bulb for indicator	2
07	05091A	Micro switch for element	1
08	02131A	Red high temperature indicator	1
09	01996A	Thermostat	1
10	04975A	12 kW 230/400 V element	1

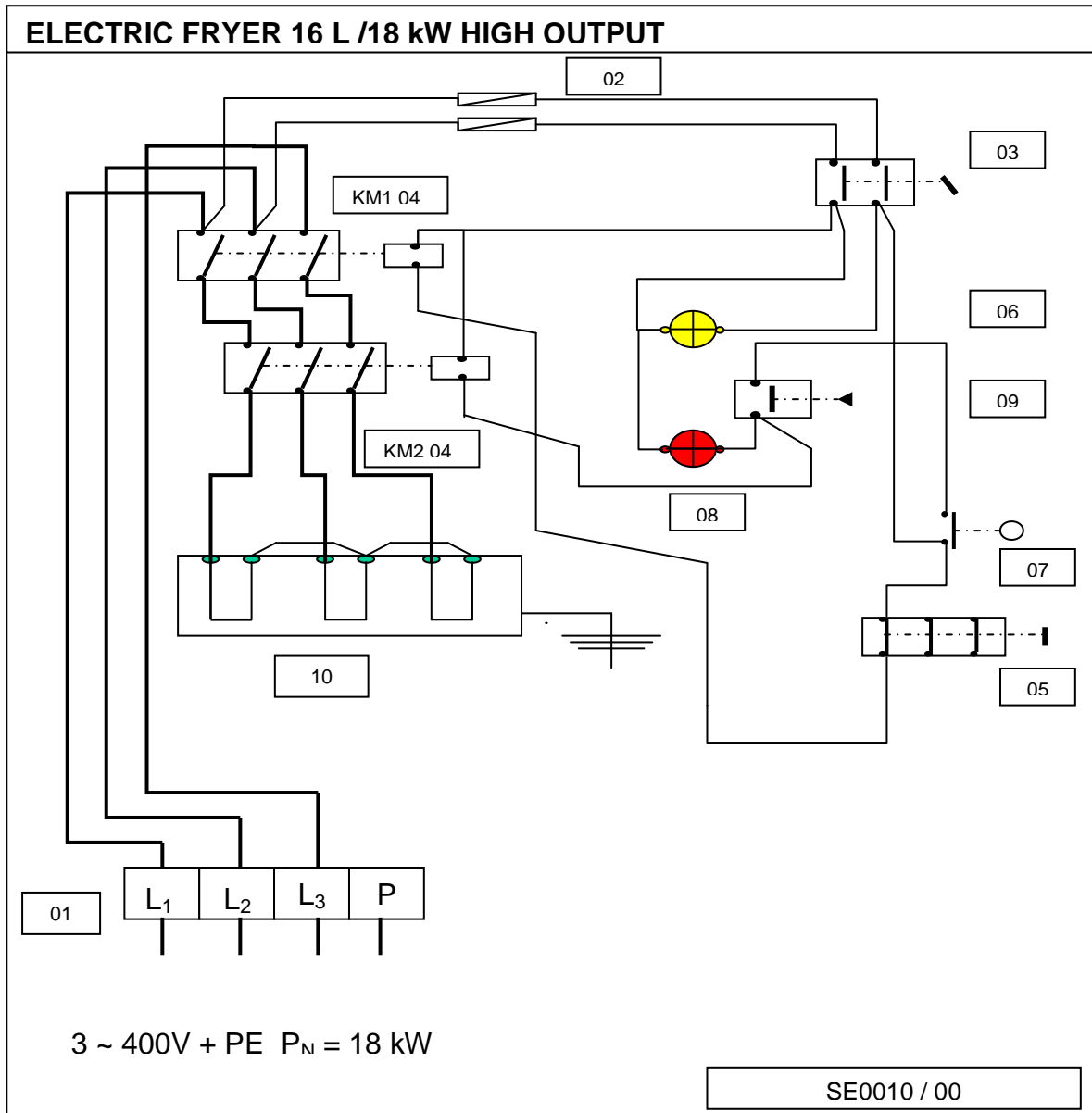

**NOMENCLATURE: ELECTRIC FRYER 16 L/18 kW (diagram: SE0010 / 00)**

Mark	Code No	Description	Quantity
01	02468A	10 A terminal box (brand : Viking)	3
01	03575A	10 A terminal box (brand : Viking)	1
01	02466A	4 A terminal box (brand : Viking)	1
02	02726A	5 mm x 20 mm fuse support	2
02	03413A	5 mm x 20 mm - 5 A fuse	2
03	02104A	Switch with handle	1
04	02200A	55 A 400 V contactor	2
05	05996A	Safety thermostat	1
06	07139A	Yellow high temperature indicator	1
07	05091A	Endless micro switch for element	1
08	07136A	Red high temperature indicator	1
09	01996A	Thermostat	1
10	07038A	12 kW 230 400 V element	1

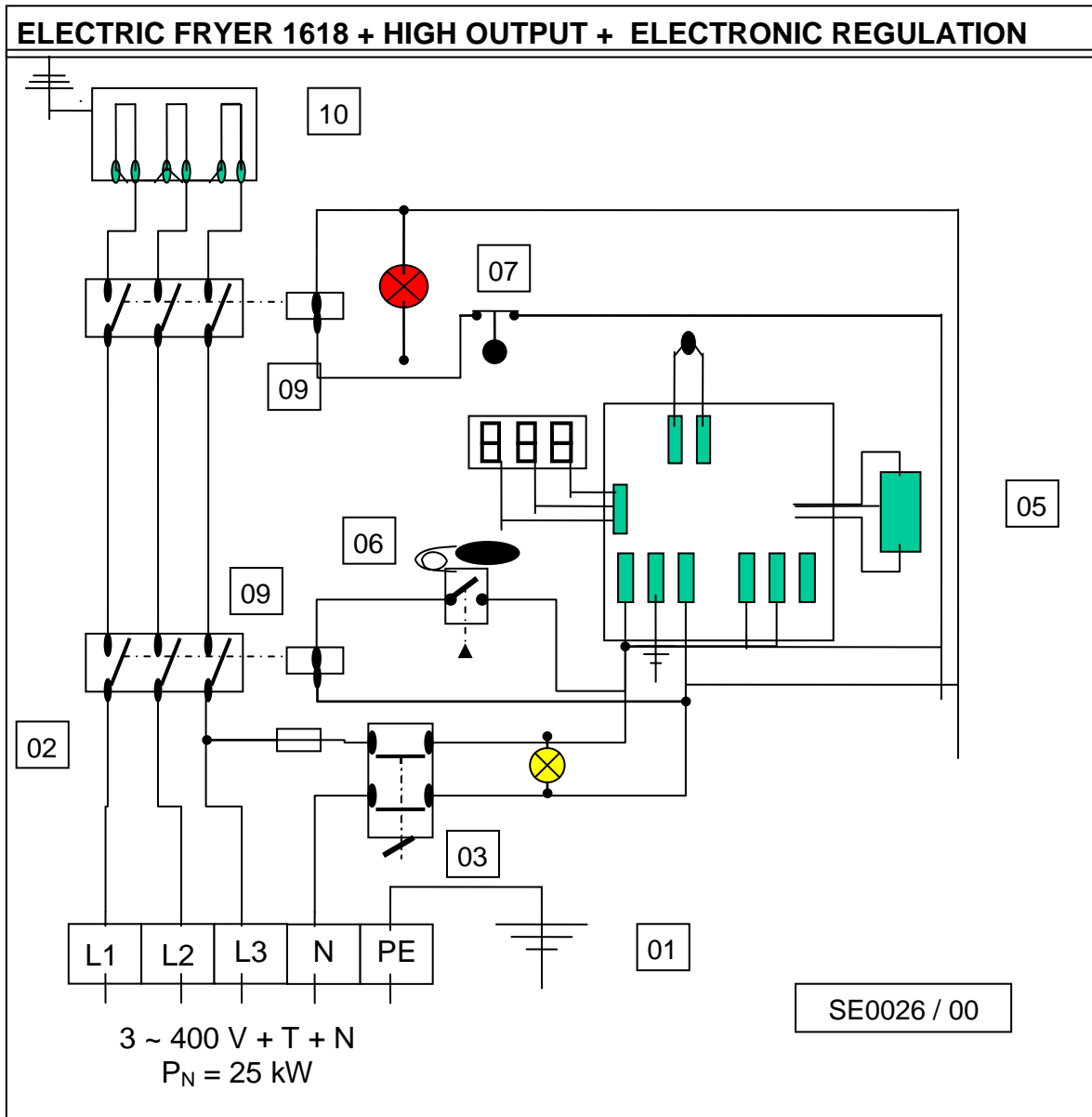

**NOMENCLATURE: ELECTRIC FRYER 1618 + high output + electronic regulation**  
(Diagram: SE0026 / 00)

Mark	Code	Description	Quantity
01	02468A	10 A terminal box (brand: Viking)	3
01	03567A	Green/Yellow 10 A terminal box (brand: Viking)	1
01	07069A	Blue terminal box (brand : Viking)	1
02	03413A	5 mm x 20 mm - 5 A fuse	1
03	02104A	Switch with handle	1
04	07139A	Yellow high temperature indicator	1
05	05771A	Electronic regulation card	1
06	05996A	Safety thermostat	1
07	05091A	Endless micro switch for element	1
08	07136A	Red high temperature indicator	1
09	02200A	400 V contactor	2
10	05598A	25 kW 400 V element	1



## 2.4. Hand over

When the apparatus is ready for use, ensure the users know how to use it properly (see users information). Formerly give the person in charge all documentation needed.

## 2.5. Reactivation of the high limit safety thermostat

Attention! The operation of the safety thermostat must be analysed before reactivation.

The fryers are equipped with a high limit safety thermostat to protect the apparatus against overheating caused by :

- A fault with the regulating thermostat,
- A fault with the contactor,
- An inadequate filling of the tank.

-> The reactivation is done by pushing the red button of the safety thermostat which is accessible by opening the cover of the element.

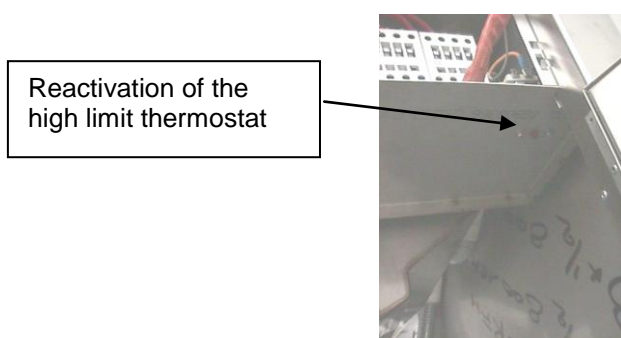









## 2.6. Checks after connection

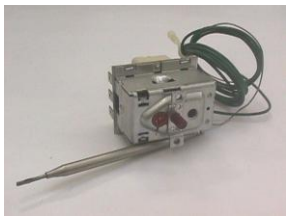

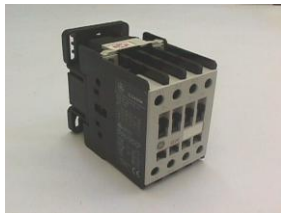

After connection, ensure that:

- The appliance is earth wired,
- The electrical equipment is properly insulated,
- The appliance is in good working conditions (see User Operation and Maintenance Instructions).

### 3. BASIC SPARE PARTS LIST

Description	Code	Part	Description	Code	Part
Element 12 kW for EFR 14/12	04975A		Element 18 kW for EFR 16/18	02055A	
Three phase high limit thermostat	05996A		Fuse 5 mmx20 mm 5 A	03413A	
Switch	02104A		Regulating thermostat	01996A	
Automatic lift (option):  - Endless microswitch	05091A		Contactor 400 V	02200A	
Electronique regulation set 09020A  Card display 09021A  Potentiometre 09023A			Indicators:  - red  - yellow	07136A  07139A	

**Option relevage automatique :**

Description Code	Part	Description Code	Part
Electronic lift 08027A		Jack 08559A	
Potentiomètre 00566A		Transformer 05917A	

# User Operation and Maintenance Instructions For Electric Fryers

Description	PRO 800 series	PRO 900 series
E2FR1412	V02210	V02212
E2FR1618HR	V02211	V02213
½ E1FR1412	V01706	V01512
½ E1FR1618HR	V01708	V01513
½ R-E1FR1412	V01707	V01744
½ R-E1FR1618HR	V02426	V02428



**ELECTRIC FRYER ON CUPBOARD**  
*(not contractual photograph)*





## S U M M A R Y

<b>1. INTRODUCTION .....</b>	<b>2</b>
<b>2. PRIOR TO STARTING UP .....</b>	<b>2</b>
<b>3. STARTING UP.....</b>	<b>2</b>
<b>3.1. OPEN THE LID .....</b>	<b>2</b>
<b>3.2. TEMPERATURE, HEATING UP TIME, COOKING TIME.....</b>	<b>3</b>
<b>3.3. PRACTICAL ADVICE.....</b>	<b>3</b>
<b>4. SWITCHING OFF.....</b>	<b>4</b>
<b>5. MAINTENANCE .....</b>	<b>4</b>
<b>5.1. CLEANING OF THE STAINLESS STEEL SURFACES .....</b>	<b>4</b>
<b>5.2. CLEANING OF THE TANK .....</b>	<b>4</b>
<b>6. POSSIBLE CAUSES OF BREAKDOWN .....</b>	<b>4</b>
<b>7. DATA PLATE .....</b>	<b>5</b>



## 1. INTRODUCTION

1. Our equipment is for professional use only and must be used by qualified staff.
2. The equipment must be installed in compliance with local codes and bylaws. It must be installed in a kitchen equipped with an adequately sized mechanical extraction system.
3. Units may be installed side by side or against walls of non combustible material. Distance to combustible material shall be no less than 10 cm.
4. It is imperative to use a qualified engineer for all new installations or modifications of existing equipment.
5. This instruction manual must be given to the user after installation.
6. WARRANTY: The warranty is mentioned in our conditions of sale. It does not cover damage due to faulty installation, misuse or inadequate maintenance.

## 2. PRIOR TO STARTING UP

- Before filling the tank with oil, clean it by boiling soapy water in the tank in order to eliminate all impurities that have accumulated during storage,
- Drain,
- Make sure that the tank is thoroughly dried before filling with oil,
- Before connecting the elements, make sure the oil level in the frying tank is correct :
  - EFR 14/12 : between marks situated on the basket holder (max. ●●●, min. ●),
  - EFR 16/18 : between the ends (top and bottom) of the graduation situated on the side of the tank,
  - Under minimum level, there is a risk of overheating,
  - Above maximum level, there is a risk of overflowing when the basket is lowered in the tank.



**Remember to turn off the elements and allow cooling before each drainage prior to cleaning.**

## 3. STARTING UP

### 3.1. Open the lid

- Turn the switch to the 'ON' position, the yellow light comes on (sign that it is connected).
- Select desired temperature by using the thermostat knob (see table on the fryer door), the red light comes on.
- The red light will go off when the desired temperature is reached. The frying basket can then be placed in the oil.



### 3.2. Temperatures, heating up time, cooking time

PRODUCTS	HEATING UP TIME*	FRYING TEMPERATURE IN DEGRE CENTIGRADE*	COOKING TIME IN MINUTE*
BLANCHED POTATOES 1 <sup>ST</sup> IMMERSION	5 – 5'30	150° - 170°	3 – 5
GOLDEN POTATOES 2 <sup>ND</sup> IMMERSION	5'30 – 6'30	170° - 190°	2 - 3
FRIES	6'30	190°	2 - 4
FISH	5'30 – 6'30	170° - 190°	2 - 5
MEAT	5'30 – 6'30	170° - 190°	2 - 3
DESERTS	6'	180°	2 - 5

\* These figures are only indicative; they vary depending on the oil quality, the quantity, and the temperature of the products put into the baskets.



**Do not preheat the bath with solid fat bars.  
Never melt solid fat bars on the elements (melt these beforehand).**

Pre-heating of solid fat is done with the thermostat on low setting (60 degrees Centigrade) during the whole melting process (this is to eliminate the risk of the fat catching fire around the element and the activation of the high limit thermostat).

### 3.3. Practical advice

The fryer allows a great variety of frying. Avoid overloading the baskets:

FRYER MODEL	LOAD IN KG FRESH FRIES	LOAD IN KG		NUMBER OF BASKET(S)
		6x6 PRE-COOKED FROZEN FRIES		
EFR 14/12	3	2.5		1
EFR 16/18HR	4	2.5		1

Your fryer is equipped with:

- A mechanical timer to help you to plan cooking time by programming the desired time. At the end of it a sound will inform you when to remove the basket.
- A hook to hang the basket to facilitate drainage; during cooking the basket rests on the element.
- A cold zone to allow the impurities to settle and not burn in the tank, resulting in a need to change the cooking oils less frequently.
- A drain tap over drip tray fitted with a filter allowing drainage of the tank as well as primary oil filtration.

The tap is fitted to the underside of the oil tank and accessible via the lower cupboard. Allow oil to cool before draining.

**Attention! The sides of the tank can be very hot after prolonged and intensive use. The handles of the draining tank will also be very hot if hot oil is being drained.**



## 4. SWITCHING OFF

Bring thermostat back to the “0” position. At the end of the day switch the electricity off.

## 5. MAINTENANCE



**This apparatus must not be cleaned with mechanical water jets or be subjected to a deluge of water splashes. Your fryer is equipped with a removable element; do not immerse the block above the filling level. Before undertaking any cleaning operations make sure the apparatus is disconnected from the supply mains.**

Wait until the apparatus has cooled down before doing anything on it. The mains must be cut off.

### 5.1. Cleaning of the stainless steel surfaces

- Wash with a sponge in soapy water (or any other neutral cleaning product).
- Do not use bleach or any other acidic product – even well diluted.
- For the tops, use a nylon scouring pad if necessary. Always go with the grain. After each cleaning rub with a greased cloth or kitchen paper.
- Finger marks can be removed with a cloth dabbed with alcohol.

### 5.1. Cleaning of the tank

- Switch off the fryer, allow the oil to cool and drain the tank. Then fill up the tank with water and a neutral cleaning agent or a product specially designed for fryers.
- Heat up at low temperature (60 deg C.).
- Switch off the apparatus again, drain, and rinse the tank.



**For best results, have your equipment serviced and cleaned on a regular basis by a qualified installer.  
Factory-sealed components must be serviced by neither installer nor user.**

## 6. POSSIBLE CAUSES OF BREAKDOWN

In case of breakdown of the regulating thermostat, a limiting thermostat will control the temperature, cut the power to the elements in plenty of time, and ensure the fryer is secure.

**Contact the supplier to replace the thermostat or the element.**



**The manufacturer and the fitter cannot be held responsible if the user neglects to ask for assistance in case of breakdown.  
Only a qualified electrician should replace the parts.**





### 7. DATA PLATE

Transfer below information written on the data plate of your apparatus. This will help you with maintenance problems and spare parts.

		<b>CHARVET S.A.</b> <b>38850 CHARAVINES</b>	
<b>Réf.</b>		<input style="width: 100%;" type="text"/>	
<b>Code:</b>	<input style="width: 150px;" type="text"/>	<b>Type:</b>	<input style="width: 100px;" type="text"/>
<b>N°FC:</b>	<input style="width: 150px;" type="text"/>	<b>Rep.</b>	<input style="width: 100px;" type="text"/>
<b>Cat.</b>	<input style="width: 100px;" type="text"/>	<input style="width: 100px;" type="text"/>	<input style="width: 100px;" type="text"/>
<b>Gaz</b>	<input style="width: 100px;" type="text"/>	<input style="width: 100px;" type="text"/>	<input style="width: 100px;" type="text"/>
<b>P (mbar)</b>	<input style="width: 100px;" type="text"/>	<input style="width: 100px;" type="text"/>	<input style="width: 100px;" type="text"/>
<b><math>\Sigma Q_n</math> (kW)</b>	<input style="width: 100px;" type="text"/>	<input style="width: 100px;" type="text"/>	<input style="width: 100px;" type="text"/>
<b><math>\Sigma V_n</math> (m<sup>3</sup>/h)</b>	<input style="width: 100px;" type="text"/>	<input style="width: 100px;" type="text"/>	<input style="width: 100px;" type="text"/>
<b><math>\Sigma M_n</math> (kg/h)</b>	<input style="width: 100px;" type="text"/>	<input style="width: 100px;" type="text"/>	<input style="width: 100px;" type="text"/>
<b>U</b>	<input style="width: 100px;" type="text"/>	<b>V</b>	<input style="width: 100px;" type="text"/>
<b>f</b>	<input style="width: 50px;" type="text"/>	<b>Hz</b>	<b>P</b>
			<input style="width: 100px;" type="text"/>
			<b>kW</b>
			<input style="width: 100px;" type="text"/>
			<input style="width: 100px;" type="text"/>
		<input style="width: 100px;" type="text"/>	
<b>MADE IN FRANCE</b>			