

Installation and Set Up Instructions For Gas Cooking Ranges

Description	MOD 1000 / PRO 1000 Series
G2GRN	V00670
G2GRL	V02344
B-G2GRN	V00702
B-G2GRL	V02346
½ B-G1GRN	V02011
½ B-G1GRL	V02347



2 GAS CAST IRON RIBBED GRIDDLES ON GAS OVEN
(not contractual photograph)





SUMMARY

1.	INSTALLATION.....	2
1.1.	GENERAL POINTS	2
1.2.	HANDLING.....	2
1.3.	INSTALLATION	2
1.4.	DATA PLATE.....	3
1.5.	FIXING THE FLUE	3
2.	CONNECTING THE APPLIANCE TO THE GAS MAIN.....	4
2.1.	CHECKS BEFORE CONNECTION	4
2.2.	CONNECTING THE APPLIANCE	4
2.3.	CHECKS AFTER CONNECTION	5
3.	CONVERSION TO OTHER TYPES OF GAS.....	5
3.1.	REPLACING BURNER NOZZLES	5
3.2.	ADJUSTING THE AIR RING.....	6
4.	POWER CONNECTIONS.....	7
4.1.	CHECKS BEFORE CONNECTION	7
4.2.	CONNECTION	7
4.3.	CHECKS AFTER CONNECTION	8
4.4.	WIRING DIAGRAMS	8
5.	BASIC SPARE PARTS LIST.....	12



1. INSTALLATION

1.1. General points

Installation must be undertaken in compliance with the following instructions and with local codes and bylaws. Ensure you have a suitable and sufficient risk assessment in place.

The user manual must be given to the user after installation.

1.2. Handling

It is imperative to leave the appliance on its wooden pallet for handling on site until the final installation.

Unpack and check the apparatus for damage upon receipt.

In case of damage, mark delivery note accordingly and immediately (within 48 hours) notify the carrier by registered mail with acknowledgement of receipt. Notify your installer.

1.3. Installation

This appliance must be installed under a suitable mechanical extraction hood, close to the gas supply.

If the apparatus is to be installed against a wall or partition, near a piece of furniture or decorative borders, it is recommended that these are made of fireproof material.

If this is not the case, they must be protected by an approved fireproof, insulating material.

All local fire regulations must be adhered to.

If in doubt fireproof construction of adjacent walls, distance to combustible material shall be no less than 10 cm.

Remove all plastic protection.

NOTICE



- **Fixed appliance:**

Install the feet or the levelling studs (they are delivered in a box kept inside the appliance). Adjust height to level the unit to an horizontal working plan of 900 mm. Fix all independent half module against the wall.

- **Mobile appliance :**

Install the castors (they are delivered in a box kept inside the appliance). The castors with brakes must be locked when the appliance is being connected and during cooking times. Fix all independent half module against the wall.

Any technical action on an apparatus must be undertaken by a qualified technician. The apparatus will have to be isolated from the electrical or gas supply for the duration of the work.

When the apparatus is ready for use ensure the users know how to use it properly (see users guide). Formerly give the person in charge all documentation needed.

WARRANTY : The warranty is specified on the conditions of sale and does not cover damage due to incorrect installation, misuse or inadequate maintenance.

Installation and Set Up Instructions For Gas Cooking Ranges

1.4. Data plate

Each apparatus has its own data plate. Transfer all the information on the data plate to the part of the user instructions booklet reserved for it (see the last page). The data plate will ease the communication between you and your client for better service. See location below:

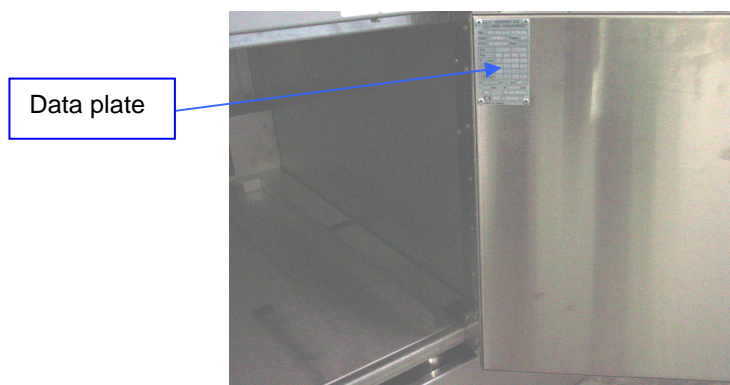

1.5. Fixing the flue

Install the flue on top of the appliance and ensure the flue is free of obstruction. To fix a short flue (300 mm > 377 mm high max.), see below:

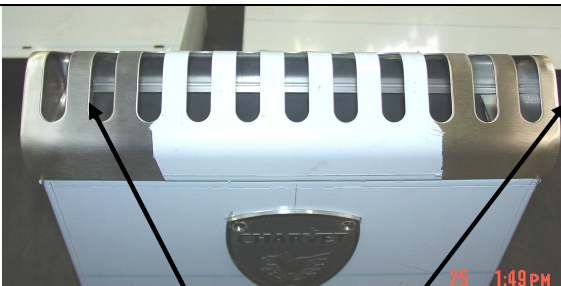
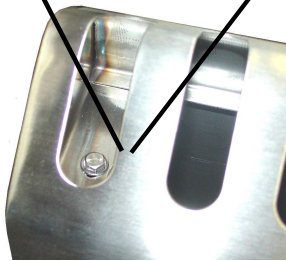
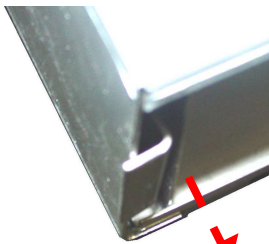
<p>Unscrew the two fixing screws located at the right and left hand sides (see Fig.1 & 2) to release the fixing fasteners (see Fig. 3).</p>	 <p>Fig. 1</p>
	 <p>Fig. 2</p>
<p>Install the flue above the space reserved for it and slide the fixing fasteners underneath the top of the appliance. Screw the two screws to fix the flue (see Fig. 1 & 2).</p>	 <p>Fig. 3</p>



2. CONNECTING THE APPLIANCE TO THE GAS MAIN

Material, assembly and welding tools must be in compliance with the standard EN 45 204.

NOTICE



- **Fixed appliance:**
Connect the burner strip to the gas mains using 1/2" NPT pipe and connections. Install a shutoff valve in the supply line allowing the unit to be isolated from the rest of the system.
- **Mobile appliance :**
Connect a 1/2" approved armoured flexible gas hose equipped with a quick disconnect fitting including automatic gas shut off to the gas connection located on the rear of the appliance. Remember to use the security chain.

2.1. Checks before connection

Ensure that:

- The supply pressure and the supply gas should match that shown on the data plate for the gas used.
- The gas supply pipe is of the correct size for minimum pressure drop as a function of length, elbows and total unit capacity.
- The gas main is free of obstruction.
- The air adjustment output is of 2 m³/h/kW. See chart A below:

CHART A			
Code of the appliance	Description of the appliance	Gas power (kW)	Air adjustment output required (m ³ /h/kW)
V00670 V02344	G2GRN G2GRL	30	60
V00702 V02346	B-G2GRN B-G2GRL	16	32
V02011 V02347	1/2B-G1GRN 1/2 B-G1GRL	8	16

2.2. Connecting the appliance

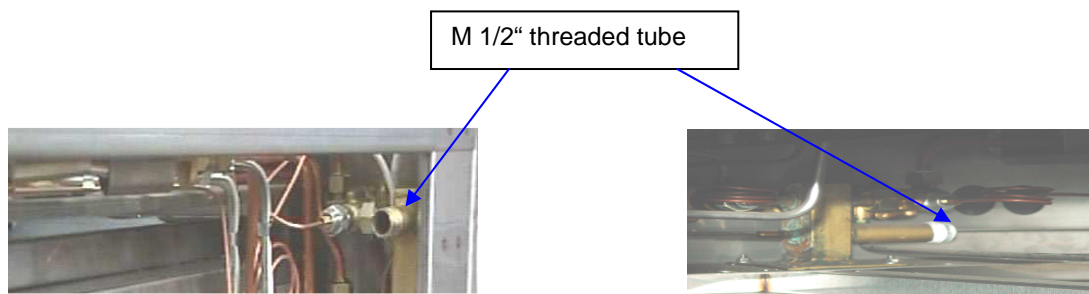

* Appliances with gas oven

- Remove control knobs
- Remove control panel (fixed with screws)
- Connect on M 1/2" threaded tube located on the burner ramp.



Installation and Set Up Instructions For Gas Cooking Ranges

2.3. Checks after connection

Ensure of:

- The watertightness of the gas pipe and connection.
- The supply pressure of the appliance. To take the pressure, do as follow:
 - Remove the control knobs,
 - Remove the control panel,
 - Connect the pressure gauge located on the ramp,
 - Put the appliance in working conditions (or all the appliances if they are connected to the same gas supply), maximum output,
 - Then check your figures with charts B-C.
- The colour of the flame (blue),
- The slow down position (see User Operation and Maintenance Instructions)
- The good working conditions of the appliance and of its safety controls.

3. CONVERSION TO OTHER TYPES OF GAS

In case there is a different type of gas from the one used normally. When done, ensure of the watertightness of the connection between the injector and its support.

3.1. Replacing burner nozzles

See charts below according to the griddle appliances:

- To choose the correct diameter depending on the nature of the gas,
- To get the right air adjustment for the air ring on the burner.

Cast iron ribbed griddles		CHART B		
Adjustment	Gas type & operating pressure	Mark engraved on the injector	Air adjustment d (mm) ²	Calorific output in kW ¹
1	G 20 : Pn = 20 mbar	210	4	8
2	G 25 : Pn = 20 mbar			
3	G 25 : Pn = 25 mbar			
4	G 30 : Pn = 29 mbar	140	5	
5	G 30 : Pn = 50 mbar			
6	G 31 : Pn = 37 mbar			
7	G 31 : Pn = 50 mbar			

Gas oven		CHART C		
Adjustment	Gas type & operating pressure	Mark engraved on the injector	Air adjustment d (mm) ²	Calorific output in kW ¹
1	G 20 : Pn = 20 mbar	280	2	14
2	G 25 : Pn = 20 mbar			
3	G 25 : Pn = 25 mbar			
4	G 30 : Pn = 29 mbar	190	3	
5	G 30 : Pn = 50 mbar			
6	G 31 : Pn = 37 mbar			
7	G 31 : Pn = 50 mbar			

- ¹ Measured power over lower calorific power of the gas (HI)
- ² Regulation of air according to diagram 1

PILOT LIGHT		CHART D	
Adjustment	Gas type & operating pressure	Mark engraved on the injector	Air adjustment d (mm) ²
1	G20 : Pn = 20 mbar	40	50%
2	G 25 : Pn = 20 mbar		
3	G 25 : Pn = 25 mbar		
4	G 30 : Pn = 29 mbar	20	Maxi
5	G 30 : Pn = 50 mbar		
6	G 31 : Pn = 37 mbar		
7	G 31 : Pn = 50 mbar		

3.2. Adjusting the air ring

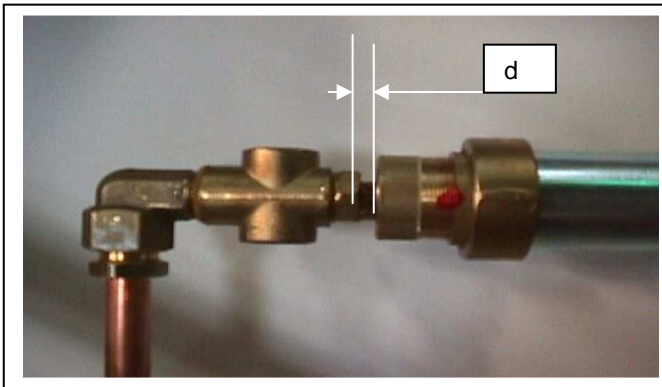

Figure 1

. Appliances on open base:

- Remove the griddle plates.
- Remove the control panel (fixed by 4 screws): you have access to the air ring and the injector.
- Release the air ring and set it back to reach the injector,
- Change the injector (use a 17 mm ring spanner). See chart B, § 3.1.
- Adjust the distance « d », tighten again and seal.

• Appliances with gas oven:

- Remove the mild steel base to reach the air ring and injector,
- Release the air ring and move it back to reach the injector,
- Change the injector (use a 17 mm ring spanner). See chart C, § 3.1.
- Adjust the distance « d », tighten again and seal.

4. POWER CONNECTIONS

Electric ignition and electric hot cupboard are considered as options.

NOTICE



**The apparatus must be earth wired.
It is dangerous to connect the apparatus unless it is earthed.**

Use a standardized cable (245 IEC 57 or 245 IEC 66) or other approved cable with the same characteristics.
Check that the electrical voltage of the supply is compatible with the voltage of the apparatus (see data plate).

. Fixed appliance

The apparatus being connected to a cable fitted with an electrical plug, the socket should be equipped with an omnipolar circuit breaker with a cross section of 3.5 mm at least. All electrical equipment must be in compliance with the European norm EN 60335.

. Mobile appliance

The apparatus being connected to a cable fitted with an electrical plug, the socket should be accessible at all times.

We cannot be held responsible for accidents due to non existent or incorrect earth link connection.

4.1. Checks before connection



All this operations are carried out when the apparatus is switched off and cold.

Before connection, ensure that:

- The supply voltage is compatible with the voltage of the apparatus,
- The cable is fixed properly,
- The connections are tight enough,
- The section of the cable is suitable for the power,
- The electrical equipment is properly insulated.

4.2. Connection

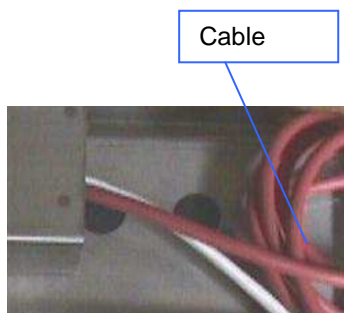

- The griddle is delivered with a high temperature flexible cable that should be connected to a standardized plug SINGLE PHASE 230V+E.

Before reassembling inspect all cables for damage.



Installation and Set Up Instructions For Gas Cooking Ranges

4.3. Checks after connection

After connection, ensure that:

- The appliance is earth wired,
- The electrical equipment is properly insulated,
- The appliance is in good working conditions: sequential regulation, electric ignition... (see User Operation and Maintenance Instructions).

4.4. Wiring diagrams

Appliance	Voltage	Wiring Diagram No
Electric ignition	1 ~ 230 V + E	SE0001/ 00
Electric hot cupboard GN1/1	1 ~ 230 V + E	SE0005 / 00
Electric hot cupboard GN2/1	3 ~ 400 V + E	SE0006 / 00

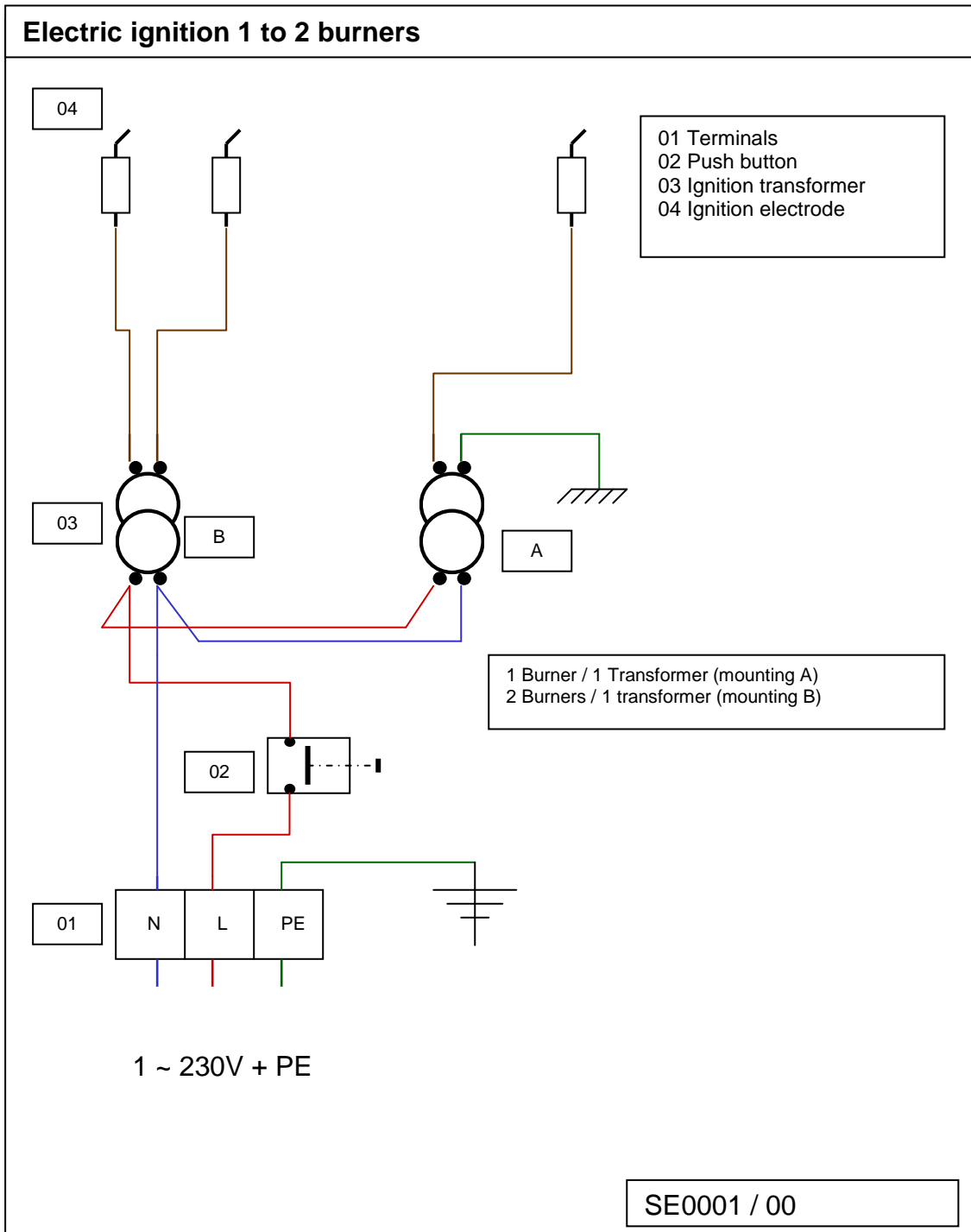

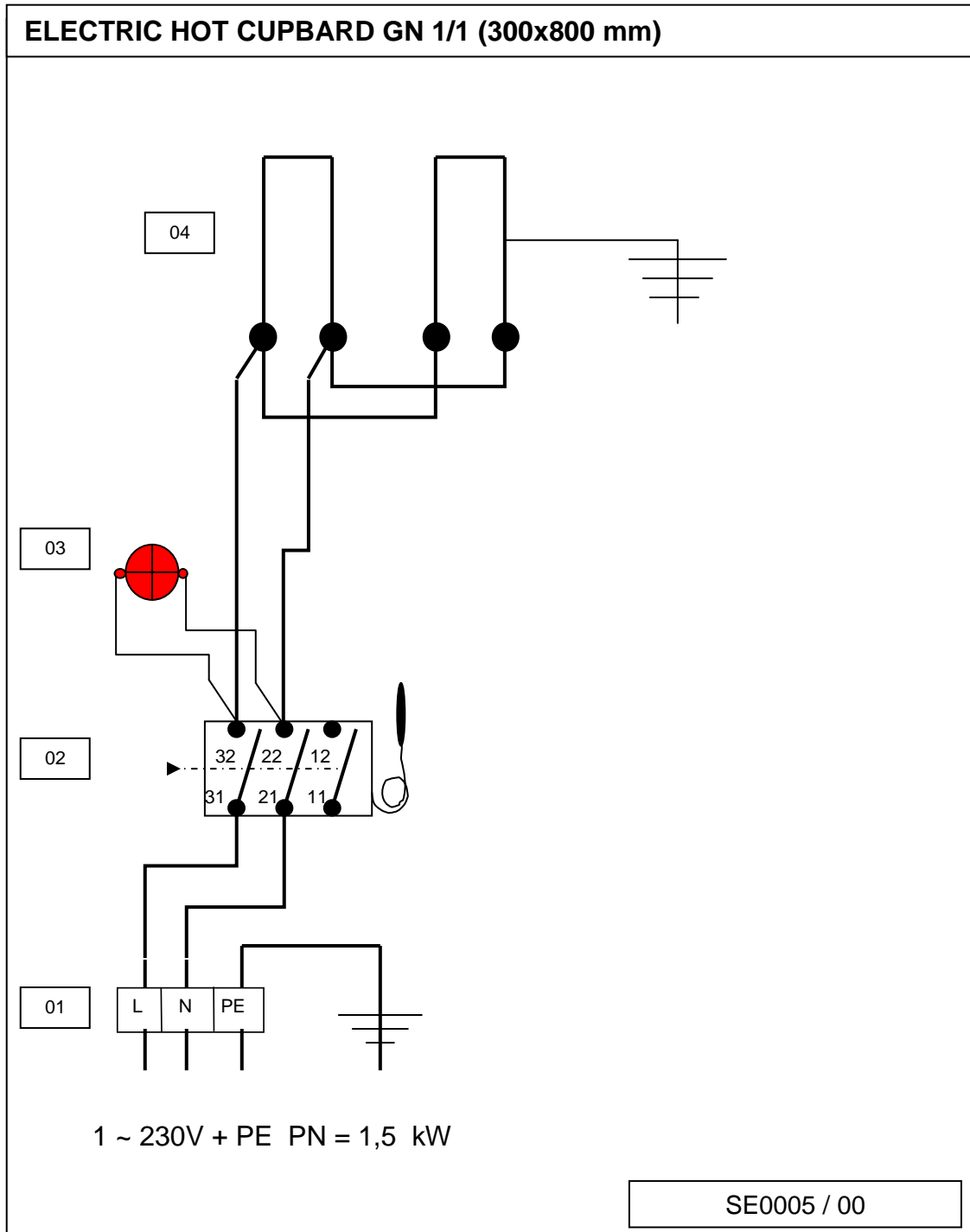

NOMENCLATURE: ELECTRIC HOT CUPBOARD GN1/1 (SE0005 / 00)



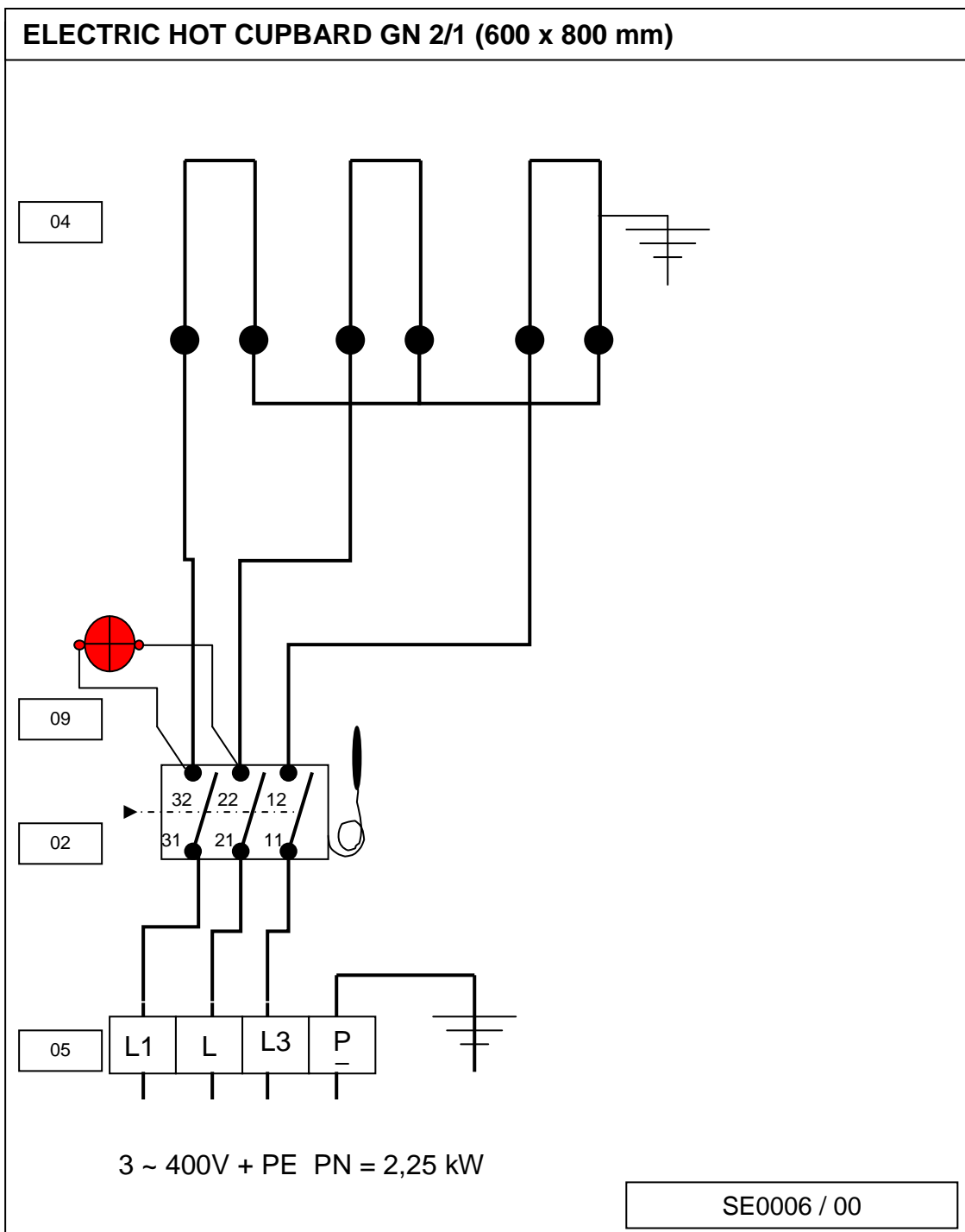







Mark	Code	Description	Quantity
01	02468A	10 mm ² terminal (brand: Vicking)	1
01	07069A	Blue terminal (brand: Vicking)	1
01	03575A	Earth terminal (brand: Vicking)	1
02	01995A	Thermostat	1
03	02141A	230 V bulb	1
03	02131A	Red indicator	1
04	02060A	750 W, 230 V stick element	2

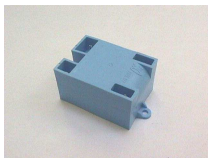
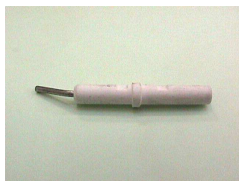

NOMENCLATURE: ELECTRIC HOT CUPBOARD GN2/1 (600x800 mm) (SE0006 / 00)

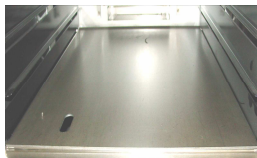



Mark	Code	Description	Quantity
01	02468A	10 mm ² terminal (brand: Vicking)	3
01	03575A	Earth terminal (brand: Vicking)	1
02	01995A	Thermostat	1
03	02142A	400 V bulb	1
03	02131A	Red indicator	1
04	02060A	750 W, 230 V stick element	3

5. BASIC SPARE PARTS LIST

Description	Code	Photograph	Description	Code	Photograph
Pilot light injectors: Ø 0.20 propane gas Ø 0.40 natural gas	01157A 06430A		Griddle injectors: Ø 1.40: propane gas Ø 2.10: natural gas	00198A 00205A	
Thermocouple	00291A		Coil thermocouple valve	00325A	
Gas tap: - Oven - Griddle plate - Open base	00503A 05226A 00502A		Ignition transformer	02161A	
Electrode	03415A		Electric ignition push button	07095A	
Mild steel base	F00162		Ribbed griddle plate 420 x 520 mm Smooth griddle plate 420 x 520 mm	F02604 05130A	
Oven injectors: φ 1.90 Propane gas φ 2,80 Natural gas	00203A 00212A		Oven thermostatic tap Thermostatic valve ST 35 (to replace the BJWA one).	00295A 08425A	 

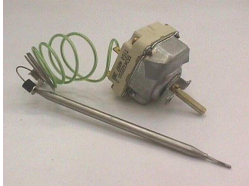

Installation and Set Up Instructions For Gas Cooking Ranges

Description	Code	Photograph	Description	Code	Photograph
Regulation thermostat 30-110 deg. Cent.	01995A		Bulb: - 230 V - 400V	02141A 02142A	
Stick elements: 750 W, 230 V	02060A		Red indicator	02131A	

User Operation and Maintenance Instructions For Gas Cooking Ranges

Description	MOD 1000 / PRO 1000 Series
G2GRN	V00670
G2GRL	V02344
B-G2GRN	V00702
B-G2GRL	V02346
1/2 B-G1GRN	V02011
1/2 B-G1GRL	V02347



**2 GAS CAST IRON RIBBED GRIDDLES ON GAS OVEN
(not contractual photograph)**





S U M M A R Y

1. INTRODUCTION	2
2. PRIOR TO STARTING UP.....	2
3. STARTING UP.....	2
3.1. BURNER.....	2
3.2. GAS OVEN.....	3
3.3. PRACTICAL ADVICE.....	3
4. SWITCHING OFF.....	3
5. MAINTENANCE	4
5.1. CLEANING OF THE STAINLESS STEEL SURFACES	4
5.2. CLEANING OF THE GRIDDLES PLATES.....	4
5.3. CLEANING OF THE OVEN.....	4
6. POSSIBLE CAUSES OF BREAKDOWN	6
6.1. UNSATISFACTORY HEATING	6
6.2. UNSATISFACTORY IGNITION	6
7. DATA PLATE	7



User Operation and Maintenance Instructions For Gas Cooking Ranges

1. INTRODUCTION

- A) Our equipment is for professional use only and must be used by qualified staff.
- B) The equipment must be installed in compliance with local codes and bylaws. It must be installed in a kitchen equipped with an adequately sized mechanical extraction system.
- C) Units may be installed side by side or against walls of non combustible material. Distance to combustible material shall be no less than 10 cm.
- D) It is imperative to use a qualified engineer for all new installations or modifications of existing equipment.
- E) This instruction manual must be given to the user after installation.
- F) **WARRANTY:** The warranty is mentioned in our conditions of sale. It does not cover damage due to faulty installation, misuse or inadequate maintenance.

2. PRIOR TO STARTING UP

Remove all plastic protection on stainless steel surfaces.

Before starting up it is advisable to clean the apparatus in order to remove all dust and impurities that have accumulated during storage.

Make sure all the control knobs are in working order before opening the gas tap.

Make sure the spillage trays and juice collector are in place.

3. STARTING UP

Each burner is equipped with a flame failure safety cut out thermocouple and a pilot light.

3.1. Burner

- Push and turn control knob counter-clockwise of desired burner (griddle plates) to the spark symbol (pilot light).
- Push the knob while igniting the desired burner or push the electric ignition button if the appliance has one (fitted as an option).
- Keep the knob pressed for about 5 to 15 seconds before releasing it.
- The pilot light must stay ignited. Try again if it did not work the first time.
- When the pilot light is on, turn the knob to the left up to the larger flame mark, the burner is now working at its full power.
- The power is slowed down by turning the knob to the next position (on the smaller flame mark).
- As the unit is heating up, wait a few minutes for full power before starting to cook.
- The heat is spread evenly to ensure cooking over the entire area.

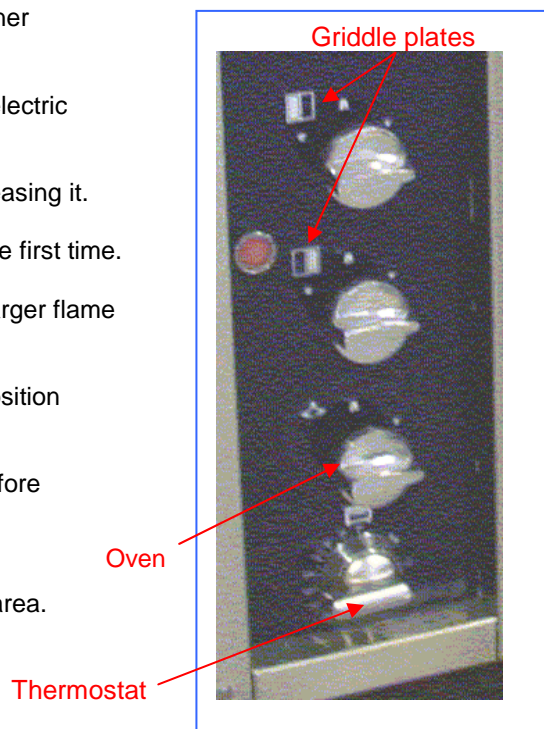



3.2. Gas oven

- Open the oven door.
- Check that you can reach the pilot light through a hole located at the front left hand side of the mild base.
- Push and turn the control knob counter-clockwise of desired burner (oven) until the arrow on the knob is opposite the spark symbol.
- Push the control knob while igniting the burner through the hole or push the electric ignition button if the appliance has one (fitted as an option).
- Keep the knob pressed for about 5 to 15 seconds before releasing it.
- The pilot light must stay ignited. Try again if it did not work the first time.
- When the pilot light is on, turn the knob to the left up to the larger flame mark, the burner is now working at its full power.
- Turn the thermostat knob to the desired temperature; the oven burner is at its full power.
- Close the oven door.

Attention!

- **Side panels and oven door may be extremely hot after a prolonged or intensive use. Be careful to open the door only with the handle.**
- **The juice collector and the spillage tray may be extremely hot; wait until they cool down or take all the necessary precautions to remove them.**

3.3. Practical advice

This GN2/1 oven (650 mm X 530 mm) accepts 50 mm high dishes, GN2/1 shelves and trays. Do not forget to place a drip tray when cooking directly on the oven shelf.

The runners allow the dishes to be levelled and centred.

Warm the oven before putting the food into it.

Any kind of food can be cooked on griddle plates. Cooking marks are printed on the food, and you can create the traditional criss-cross pattern marked on grilled meats.

The grease is flowing out more easily with the inclined grid.

4. SWITCHING OFF

Bring the control knobs back to the "●" position as well as the oven thermostat.

Wait until the apparatus has cooled down before doing anything on it.

Clean carefully the apparatus after each use (do not let the remaining food dry and empty the juice collector and spillage drawer).

At the end of the day, cut off gas supply or switch off electricity at the mains.



5. MAINTENANCE

Wait until the apparatus has cooled down before doing anything on it. The mains must be cut off.

5.1. Cleaning of the stainless steel surfaces

- Wash with a sponge in soapy water (or any other neutral cleaning product).
- Do not use bleach or any other acidic product – even well diluted.
- For the tops, use a nylon scouring pad if necessary. Always go with the grain.
- Clean with a greasy cloth to avoid rusting.
- Finger marks can be removed with a cloth dabbed with alcohol.

5.2. Cleaning of the griddle plates

- Use a griddle scraper, a wire brush or an abrasive pad to remove burnt on particles.
- Wipe a little cooking oil over the tray and griddle plates.

5.3. Cleaning of the oven

- Clean daily the internal sides of the oven to avoid smoke due to grease deposits or spottings.
- The mild base can be removed for easy cleaning and for access to the burner housing (see p. 5).
- The enamelled steel removable shelf supports can be plunged in soapy water (see p. 5).

All the above cleaning operations are handled with a sponge in soapy water (or any other neutral cleaning product).

- Rinse and dry all the parts.
- Put back all the parts in correct position.

Please find here under the weight of some parts*:

Description	Weight (kg)
Mild base*	23 kg
Cast iron pan support*	10.6 kg
Oven shelf	3.2 kg
Water tank	3 kg
Shelf supports	2.6 kg

* *heavy parts*



- **Removing procedure of the oven parts**

- Pull the oven shelf towards oneself (A).
- Put the fingers in the hole of the oven mild base and pull it towards oneself (B).

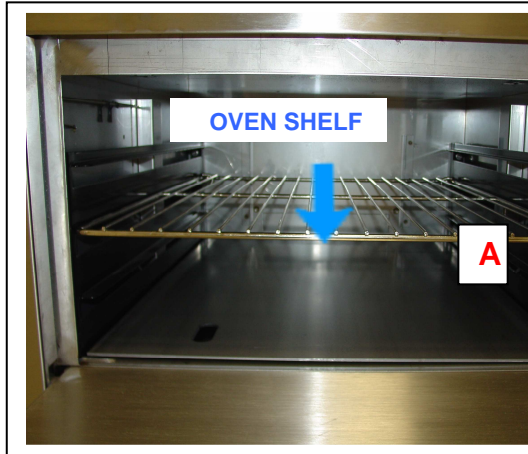

- Lift the removable shelf supports and pull to disengage them from the oven sides (1 & 2).
- Pull the removable shelf supports towards oneself (3).

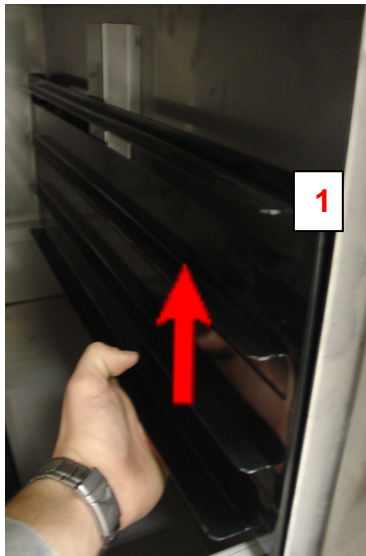



This apparatus must not be cleaned with water under pressure or too much water splashed onto the burners as this might obstruct the gas supply.

For the electric ignition option, ensure that it is switched off at the mains.

For best results, have your equipment serviced and cleaned on a regular basis by a qualified installer (for the list of spare parts, see attached installation and set-up instructions).

CAUTION: Factory-sealed components must be serviced by neither installer nor user.

6. POSSIBLE CAUSE OF BREAK DOWN

6.1. Unsatisfactory heating

- Clogging of the burners, injectors...
- Incorrect gas pressure.
- Incorrect grading of the injectors.
- Faulty thermostat.
- Clogging of the rear internal flue box.

6.2. Unsatisfactory ignition

- Clogging of the pilot light or of the thermocouple.
- Difficult ignition of the thermocouple or pilot light flow: control knob are not positioned correctly or not pushed far enough.
- Incorrect position of the spark plug.



Contact the supplier to replace faulty parts.

Only a qualified electrician should replace the switch or the cooking surface.

The manufacturer and the installer cannot be held responsible if the user neglects to ask for assistance in case of breakdown.



7. DATA PLATE

Transfer below information written on the data plate of your apparatus. This will help you with maintenance problems and spare parts.



CHARVET S.A.
38850 CHARAVINES

Réf.

Code: Type:

N°FC: Rep.

Cat.			
Gaz			
P (mbar)			
ΣQ_n (kW)			
ΣV_n (m ³ /h)			
ΣM_n (kg/h)			

U V Ip

f Hz P kW

CE

MADE IN FRANCE