

Electric hot cupboards

PRO800 Series

Electric hot cupboard GN 1/1



- ✓ **V01709: 1/2PRO800 E1ETUV6-1/1**
- ✓ **V01710: PRO800 E1ETUV6-2/1**

Installation instructions

Electric hot cupboards

1. INSTALLATION

1.1. General points

Installation must be undertaken in compliance with the following instructions and with local codes and bylaws.

The instruction manual must be given to the user after installation.

1.2. Handling and installation

It is imperative to leave the appliance on its wooden pallet for handling on site until the final installation.

Unpack and check the apparatus for damage upon receipt.

In case of damage, mark delivery note accordingly and confirm this within 48 hours by registered letter with acknowledgement of receipt, with the haulage contractor.

1.3. Installation

(See technical notes)

This appliance must be installed under a suitable mechanical extraction hood.

If the apparatus is to be installed against a wall or partition, near a piece of furniture or decorative borders, it is recommended that these are made of fireproof material.

If this is not the case, they must be protected by an approved fireproof, insulating material.

All local fire regulations must be adhered to.

If in doubt about fireproof construction of adjacent walls, distance to combustible material shall be no less than 10 cm.

- Remove all plastic protections
- Install the feet (they are delivered in a box kept inside the appliance)
- Adjust height of feet to level the unit to an horizontal working plan of 900 mm.

1.4. Electrical connections

The equipment must be connected in compliance with the rules and regulations listed in this notice and with local bylaws.

Use a standardized cable (245 IEC 57 or 245 IEC 66) or any other cable with the same characteristics.

If the apparatus is permanently connected to a fixed electrical conduit, the supply should be equipped with an Earth Leakage Circuit Braker.

If the apparatus is connected to a cable fitted with an electrical plug, the socket should be accessible at all time.

- **Before connection :**



Electric hot cupboards

- Check that the electrical voltage of the supply is compatible with the voltage of the apparatus (see data plate).
- It is recommended that the supply is fitted with an earth leakage circuit breaker.

The apparatus is wired at the factory according to requirements notified at the time of order. For any change of voltage required during the lifetime of the apparatus, consult the manufacturer :

- single phase 230 V~ +E GN 1/1 hot cupboard
- three phase 400 V~ +E GN 2/1 hot cupboard

Change of voltage :

- for each power the elements are coupled together
- please refer to the wiring diagram for any change of voltage



Electric hot cupboards

1.5. Connection to voltage

- Monitoring and checks :

Before proceeding ensure that :

- The supply voltage is compatible,
- The cable is fixed properly,
- The connections are tight enough,
- It is earth wired,
- The section of the cable is suitable for the power,
- The electrical equipment is properly insulated,
- The electrical phasing of the supply is correct for the appliance.

- Adjustments :

There is normally no adjustment to do.

2. STARTING UP

(See part relating to service operation for users)

- Connection :

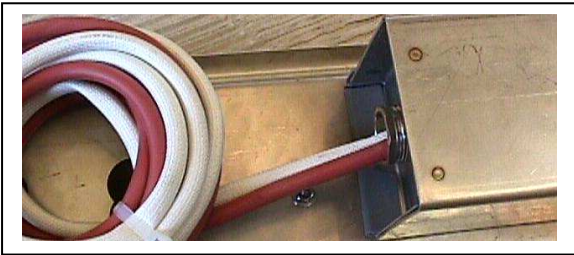

The apparatus is delivered with a high temperature cable. Install a standardized single phase 230V+E plug. Connect the apparatus to a standardized socket. Make sure that socket is correctly protected in the electrical box.



Before starting up the appliance :

- ensure that all the plastic protections are removed,
- inspect all cables for damage.

The appliance must be earth wired.

It is dangerous to connect the apparatus without an earth connection.

We cannot be held responsible for accidents due to non existent or incorrect earth link connection.

WIRING DIAGRAMS :

Apparatus	Power	No electric diagram
GN1/1 hot cupboard	1 ~ 230 V + PE	SE0005/00
GN2/1 hot cupboard	3 ~ 400 V + PE	SE0006/00

3. INTERVENTIONS

Any breakdown action on an apparatus must be undertaken by a qualified technician.

The apparatus will have to be isolated from the electrical supply for the duration of this work.



Electric hot cupboards



When the apparatus is ready for use, ensure the users know how to use it properly (see users information). Formerly, give the person in charge all documentation needed.



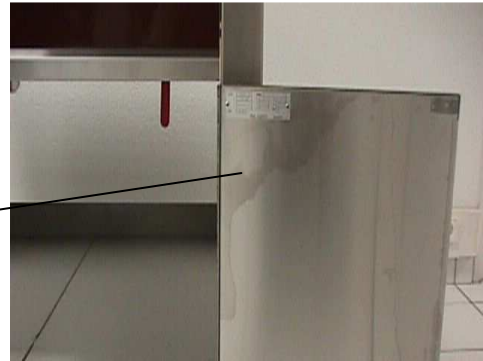

Each apparatus has an identification data plate. Transfer the information on the data plate to the part of the instruction manual reserved for it.

Data plate

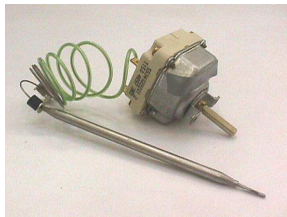

WARRANTY : The warranty is specified on our conditions of sale.
This warranty does not cover damage due to incorrect installation, misuse or inadequate maintenance.

4. BASIC SPARE PARTS LIST

Description	Code	Parts	Description	Code	Parts
Element 750 W 230 V	02060 A		Bulb 230 V (GN 1/1 hot cupboard)	02141 A	
			400 V (GN 2/1 hot cupboard)	02142 A	
Regulation thermostat 30-110 °C	01995 A		Red high temperature light	02131 A	

Electric hot cupboards

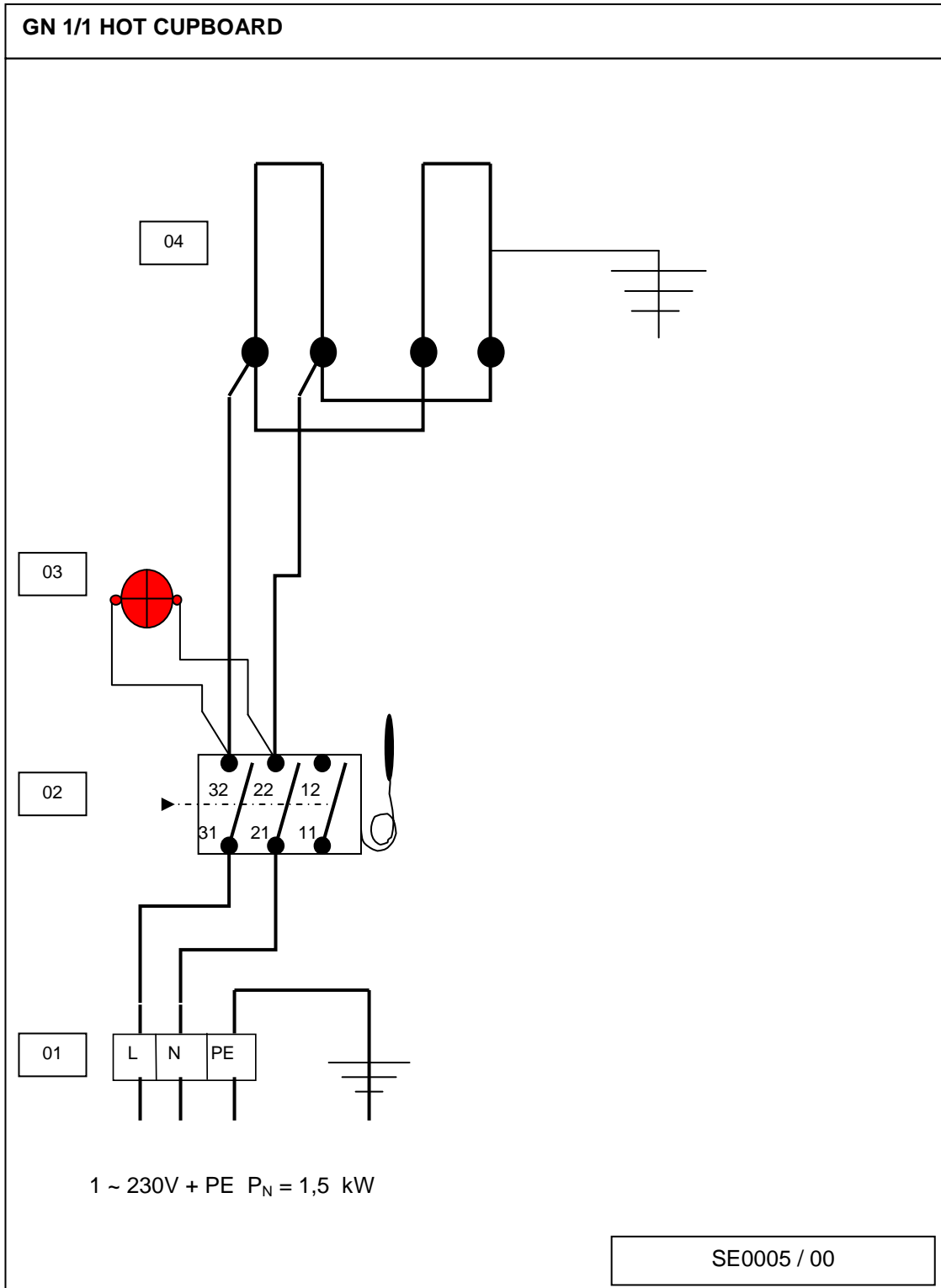

GN 2/1 HOT CUPBOARD

Paul CHARVET S.A.
1170 rue Principale
F-38850 CHARAVINES
Tel. (33) 4 760 664 22
Fax (33) 4 765 578 75
E-mail : info@charvet.fr



Instruction Sheet: 800 EN ETUV
ind. A - Edited on: 23/07/2002

page: 6/14

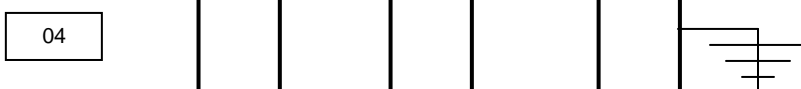

Electric hot cupboards



Electric hot cupboards

NOMENCLATURE : GN 1/1 hot cupboard (electric diagram : SE0005 / 00)

Marks	Code	Description	Quantity
01	02468A	10 A terminal box (brand : Viking)	3
01	03575A	10 A terminal box (brand : Viking)	1
02	01995A	30-110°C thermostat	1
03	02131A	Red light	1
03	02141A	230 V bulb	1
04	02060A	750 W 230 V element	2

NOMENCLATURE : GN 2/1 hot cupboard (electric diagram : SE0006 / 00)

Marks	Code	Description	Quantity
01	02468 A	10 A terminal box (brand : Viking)	3
01	03575 A	10 A terminal box (brand : Viking)	1
02	01995 A	30-110°C thermostat	1
03	02131 A	Red light	1
03	02142 A	400 V bulb	1
04	02060 A	750 W 230 V element	3



Electric hot cupboards

PRO800 series

Electric hot cupboard GN 1/1



- ✓ **V01709 : ½PRO800 E1ETUV6-1/1**
- ✓ **V01710 : PRO800 E1ETUV6-2/1**

USERS' INSTRUCTIONS

Electric hot cupboards

1. INTRODUCTION

- A) Our equipment is for professional use only and must be used by qualified staff.
- B) The equipment must be installed in compliance with local codes and bylaws. It must be installed in a kitchen equipped with an adequately sized mechanical extraction system.
- C) Units may be installed side by side or against walls of non-combustible material. Distance to combustible material shall be no less than 10 cm.
- D) It is imperative to use a qualified engineer for all new installations or modifications of existing equipment.
- E) This instruction manual must be given to the user after installation.
- F) **WARRANTY:** *The warranty is mentioned in our conditions of sale. It does not cover damage due to faulty installation, misuse or inadequate maintenance.*

Dimensions:

GN2/1 hot cupboard: L: 850 mm x D: 800 mm x H: 900 mm

GN1/1 hot cupboard: L: 425 mm x D: 800 mm x H: 900 mm

Construction:

One-piece seam welded 18-10 stainless steel chassis, 1 to 3 mm thick,
18-10 stainless steel top frame, with a 55mm high edge having an 18mm radius and return to underside (note : F17 stainless steel top frame on electric boiling plate appliances),
18-10 stainless steel side panels, 1 mm thick; assembly with no visible screws,
Anodised aluminium joining-strips fitted between appliances when ordered as a cooking suite,
Recessed gas and electric controls on enamelled steel panels with control symbol markings,
200 mm high stainless steel legs with adjustable PVC feet (+10/-20), Ø 60.3 mm.

Top:

18-10 stainless steel top, 2 mm thick.

Base:

18-10 stainless steel hot cupboard with 6 fixed shelf runners (space between runners: 60 mm),
Insulated from 10 to 25 mm thick (top, back and sides),
18-10 stainless steel door and inner door with stainless steel handle and magnetic hasp.

Heat:

Thermostatic regulation 30 to 110 degrees Centigrade with stop position and "on" light,
GN 1/1 hot cupboard: 2 elements for a total power of 1.5 kW – single phase 230V+E,
GN 2/1 hot cupboard: 3 elements for a total power of 2.25 kW – three phase 400V+E.



Electric hot cupboards

2. PRIOR TO INITIAL START UP

- a) Remove all plastic protection to clean the tank in order to eliminate all impurities that might have accumulated during storage.
- b) Clean the apparatus with a wet sponge.



Stop heating elements before cleaning and wait until the apparatus has cool down to avoid risk of burns.

3. START UP

The apparatus being connected:

- Turn the regulation thermostat knob to the desired temperature (90/95 degrees Centigrade).
- > the light comes on.



Electric hot cupboards

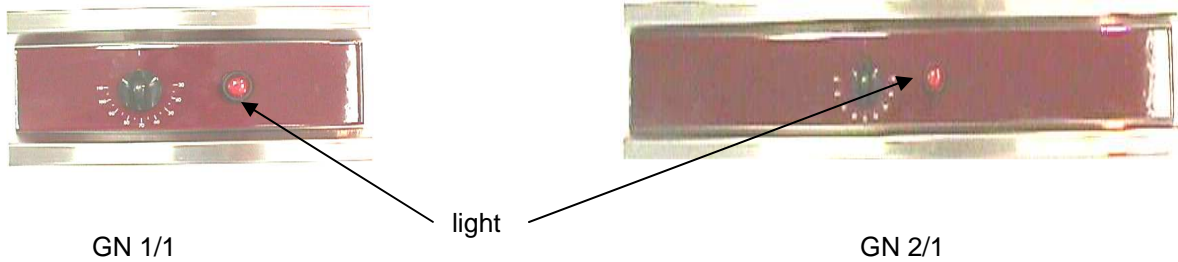

Use of the hot cupboard as a plate warmer:

- Insert the plates 2 hours before the first sitting starts,
- Despatch the plates at the rear of the hot cupboard and on the shelf to allow a better heat,
- Turn the thermostat to 50/60 degrees Centigrade.

Use of the hot cupboard to keep the food warm:

- Preheat the hot cupboard for about 30 minutes before loading the dishes (see the local bylaws about keeping the food warm),
- Turn the thermostat to 75/85 degrees Centigrade (note: take into account the type of food and the quantity).

Practical advice

- There are many storage possibilities with GN 1/1 or GN 2/1 containers (not supplied) and with the cooking containers,
- The food containers are inevitably covered with a heatproof lid.

ATTENTION

Do not use the hot cupboards to reheat the food which must be at a minimum of 63 degrees Centigrade when loaded. Side panels may be very hot after an intensive or prolonged use. Take the appropriate utensils to unload the hot dishes.

4. SWITCHING OFF

- Bring back the thermostat to 0 position,
- Switch off electricity at the end of the day.

5. MAINTENANCE

- Clean with a sponge and soapy water or any other neutral cleaning agent. *Do not use bleach or any other acidic product even well diluted.*
- For the tops if necessary use a nylon scouring pad making sure to follow the grain of the polish.
- After each cleaning rub with a greased cloth or kitchen paper.
- Finger marks can be removed with a cloth dabbed with alcohol.

Electric hot cupboards

ATTENTION

This apparatus must not be cleaned with power jets or be subjected to a deluge of water. Make sure the apparatus is not connected.

For better service, regular maintenance by qualified staff is recommended depending on the intensity of use.

Some parts of the apparatus, specifically the thermostats, guaranteed by the manufacturer, must not be adjusted either by the fitter or user.

6. POSSIBLE CAUSE OF BREAK DOWN

- The light comes on when the thermostat is engaged:
 - damaged element(s)
 - cable defect
- The light doesn't come on when the thermostat is engaged:
 - thermostat defect
 - no electricity supply
- The apparatus heats but the light is not on:
 - bulb defect



Contact your supplier to replace the elements or thermostat. Only a qualified electrician should replace the electrical components.

The manufacturer and the fitter cannot be held responsible if the user neglects to ask for assistance in case of breakdown.

Electric hot cupboards

Transfer below information written on the data plate of your apparatus.

 **CHARVET S.A.**
38850 CHARAVINES

Réf.

Code: Type:

N°FC: Rep.

Cat.				
Gaz				
P (mbar)				
ΣQ_n (kW)				
ΣV_n (m ³ /h)				
ΣM_n (kg/h)				

U V Ip

f Hz P kW



MADE IN FRANCE

This will help you with maintenance problems and spare parts.

