

Electric deep fat fryer

PRO900 Series

**Oil capacity 9 litres
E1FR0909, R-E1FR0909**



**V02209 . V02215 : ½ PRO900 E1FR0909, R-E1FR0909
V01704 . V01705 : ½ PRO800 E1FR0909, R-E1FR0909**

Installation and setup instructions

Electric deep fat fryer

1. INSTALLATION

.1. General points

Installation must be undertaken in compliance with the following instructions and with local codes and bylaws.

The instruction manual must be given to the user after installation.

.2. Handling

It is imperative to leave the appliance on its wooden pallet for handling on site until the final installation.

Unpack and check the apparatus for damage upon receipt.

In case of damage, mark delivery note accordingly and confirm this within 48 hours by registered letter with acknowledgement of receipt, with the haulage contractor.

.3. Installation

(See technical notes)

This appliance must be installed under a suitable mechanical extraction hood.

If the apparatus is to be installed against a wall or partition, near a piece of furniture or decorative borders, it is recommended that these are made of fireproof material.

If this is not the case, they must be protected by an approved fireproof, insulating material.

All local fire regulations must be adhered to.

If in doubt about fireproof construction of adjacent walls, distance to combustible material shall be no less than 10 cm.

- Remove all plastic protection,
- Install the feet (they are delivered in a box kept inside the appliance),
- Adjust height of feet to level the unit to an horizontal working plan of 900 mm.

The equipment must be connected in compliance with the rules and regulations listed in this notice and with local bylaws.

Attention

Use a standardized cable (245 IEC 57 or 245 IEC 66) or any other cable with the same characteristics.

If the apparatus is permanently connected to a fixed electrical conduit, the supply should be equipped with an earth leakage circuit breaker.

If the apparatus is connected to a cable fitted with an electrical plug, the socket should be accessible at all times.



Electric deep fat fryer

- Before connection :
 - Check that the electrical voltage of the supply is compatible with the voltage of the apparatus (see data plate).
 - It is recommended that the supply is fitted with an earth leakage circuit breaker.

The apparatus is wired at the factory according to requirements notified at the time of order. For any change of voltage required during the lifetime of the apparatus consult the manufacturer.

.4. Connection to voltage

- Monitoring and checks

Before proceeding ensure that:

- The supply voltage is compatible
- The cable is fixed properly
- The connections are tight enough
- It is earth wired
- The cable is suitable for the power requirements
- The electrical equipment is properly insulated
- The electrical phasing of the supply is correct for the appliance.

Operation:

(See part relating to service operation for users)



**Never put the apparatus into operation with an empty tank.
For trials without oil fill up the tank with water at the appropriate levels.**

- Settings

None.

- Starting up

(SEE the user's manual)

2. CONNECTION

- Dismantle front control panel to reach the terminal box (fixed with clips),
- Thread cable through right hand side panel of the frame, enter terminal box through back opening,
- Connect supply cable to terminal by following diagrams below, making sure to follow instructions on the box,
- Before reassembling, inspect all cables for damage.

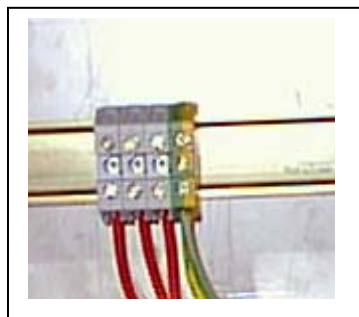

Electric deep fat fryer

- **Fixed and mobile appliances:**

- ✓ The apparatus being connected to a cable fitted with an electrical plug, the socket should be equipped with an omnipolar circuit breaker with a cross section of 3.5 mm at least. All electrical equipment must be in compliance with the European norm EN 60335.
- ✓ The apparatus being connected to a cable fitted with an electrical plug, the socket should be accessible at all times.



The apparatus must be earth wired. It is dangerous to connect the apparatus without earth connection.
We cannot be held responsible for accidents due to non existent or incorrect earth link connection.

WIRING DIAGRAM:

Apparatus	Voltage	N° electrical diagram
EFR 09/09	3 ~ 400 V + E	SE0012 / 00

3. SERVICING



Any breakdown action on an apparatus must be undertaken by a qualified technician.
The apparatus will have to be isolated from the electrical supply for the duration of this work.

.1. Hand over

When the apparatus is ready for use, ensure the users know how to use it properly (see users' information). Formerly give the person in charge all documentation needed.

.2. Reactivation of the high limit security thermostat

The fryers are equipped with a high limit security thermostat to protect the apparatus against overheating caused by:

- A fault with the regulating thermostat,
- A fault with the contactor,
- An inadequate filling of the tank.

-> The reactivation is done by pushing the red button of the security thermostat which is accessible by opening the cover of the element.



Electric deep fat fryer

Reactivation of the high limit thermostat



Attention! The operation of the security thermostat must be analysed before reactivation.

.3. Identification of the apparatus:

Each apparatus has its own identification data plate. Transfer the information on the data plate to the part of the instruction manual reserved for it.

Data plate

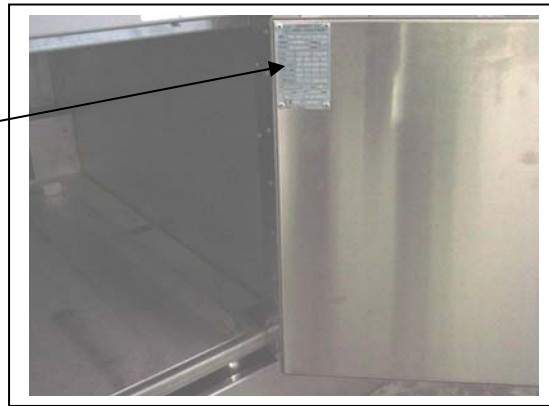

Warranty:

The warranty is specified on our conditions of sale.

This warranty does not cover damages due to incorrect installation, misuse or inadequate maintenance.

Electric deep fat fryer

4. BASIC SPARE PARTS LIST

Description	Code	Part	Description	Code	Part
Mechanical timer	02167A		Element 9 kW	02822A	
Lamp 400 V	02142A		Switch ON/OFF	01073A	
Thermostat Regulation	02824A		Limiting thermostat	02823A	
Socket	00371A		Male index card	02827A	
Indicators 400 V . red . yellow	07139A 07136A		Contactor 400 V	06738A	

Electric deep fat fryer

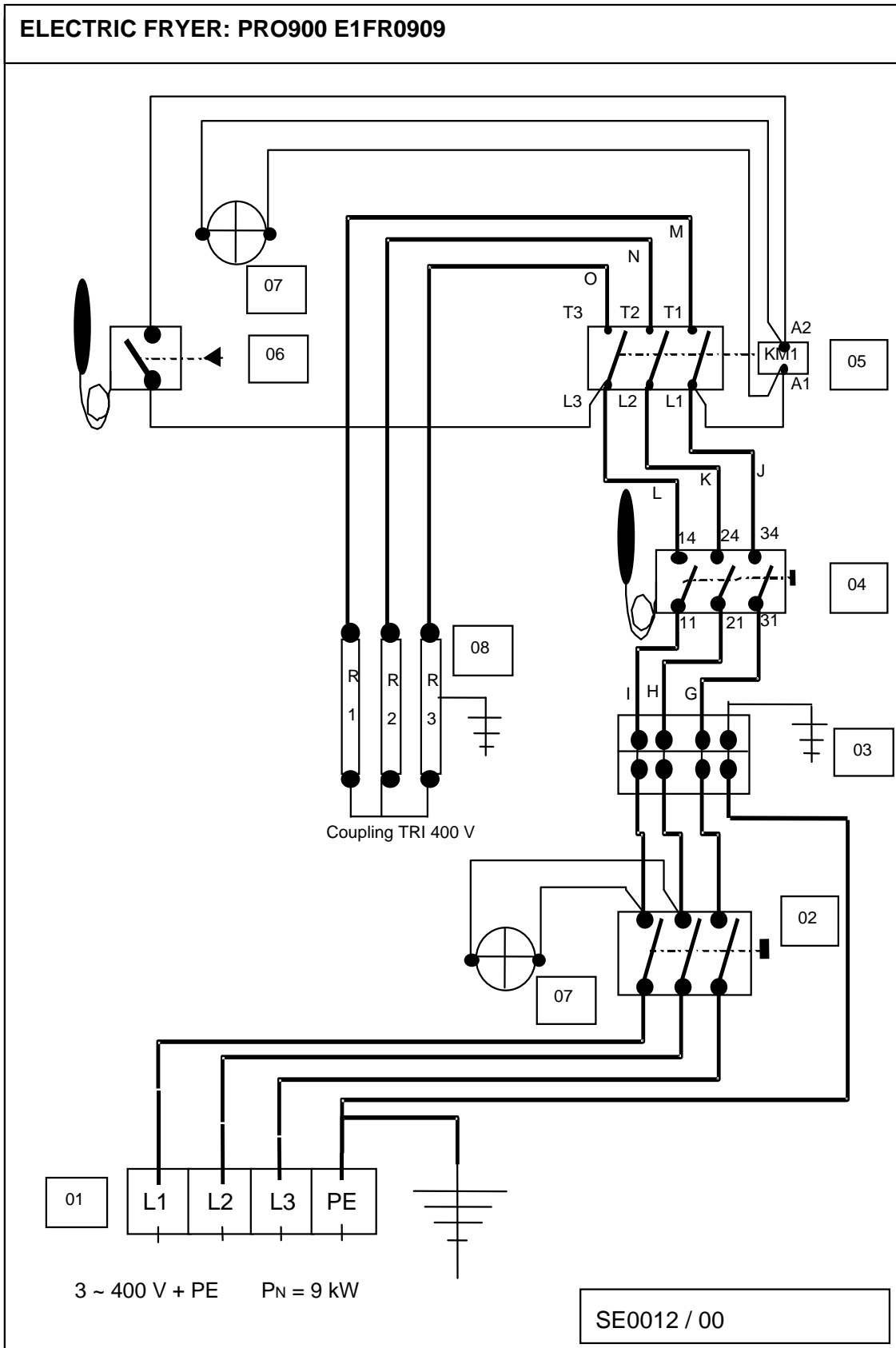

Electric deep fat fryer

NOMENCLATURE: EFR 09/09 (Wiring diagram: SE0012 / 00)

Mark	Reference	Description	Quantity
01	02468A	10 A Viking terminal box	3
01	03575A	10 A Viking terminal box	1
02	01073A	Switch with handle	1
03	02827A	Male plug	1
03	00371A	Female plug	1
04	02823A	Safety thermostat	1
05	06738A	Contacteur for solenoid 400 V	1
06	02824A	Regulation thermostat	1
07	07136A	Yellow indicator 400 V	1
07	07139A	Red indicator 400 V	1
08	02822A	Electric element 9 kW, 230 / 400 V	1



Electric deep fat fryer

PRO900 Series

**Oil capacity 9 litres
E1FR0909, R-E1FR0909**



**V02209 . V02215 : ½ PRO900 E1FR0909, R-E1FR0909
V01704 . V01705 : ½ PRO800 E1FR0909, R-E1FR0909**

Operating and maintenance instructions

Electric deep fat fryer

3. INTRODUCTION

- A) Our equipment is for professional use only and must be used by qualified staff.
- B) The equipment must be installed in compliance with local codes and bylaws. It must be installed in a kitchen equipped with an adequately sized mechanical extraction system.
- C) Units may be installed side by side or against walls of non combustible material. Distance to combustible material shall be no less than 10 cm.
- D) It is imperative to use a qualified engineer for all new installations or modifications of existing equipment.
- E) This instruction manual must be given to the user after installation.
- F) **WARRANTY:** The warranty is mentioned in our conditions of sale. It does not cover damage due to faulty installation, misuse or inadequate maintenance.

2. PRIOR TO INITIAL START UP

- Before filling the tank with oil, clean it by boiling soapy water in the tank in order to eliminate all impurities that have accumulated during storage,
- Drain,
- Make sure that the tank is thoroughly dried before filling with oil,
- Before connecting the elements, make sure the oil level in the frying tank is correct:
 - EFR 09L: between marks situated on the basket holder (fig. A),
 - Under minimum level, there is a risk of overheating,
 - Above maximum level, there is a risk of overflowing when the basket is lowered in the tank.

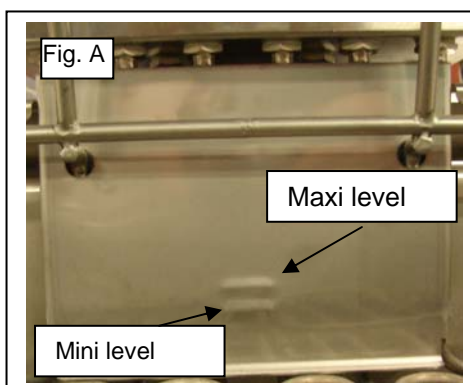

Remember to turn off the elements and allow cooling before each drainage and prior to cleaning.

Electric deep fat fryer

2. START UP

.1. Open the lid:

- Turn the switch to the 'ON' position, the yellow light comes on (sign that it is connected).
- Select desired temperature by using the thermostat knob (see table on the fryer door), the red light comes on. The apparatus is connected.
- The red light will go off when the desired temperature is reached. The frying basket can then be placed in the oil.

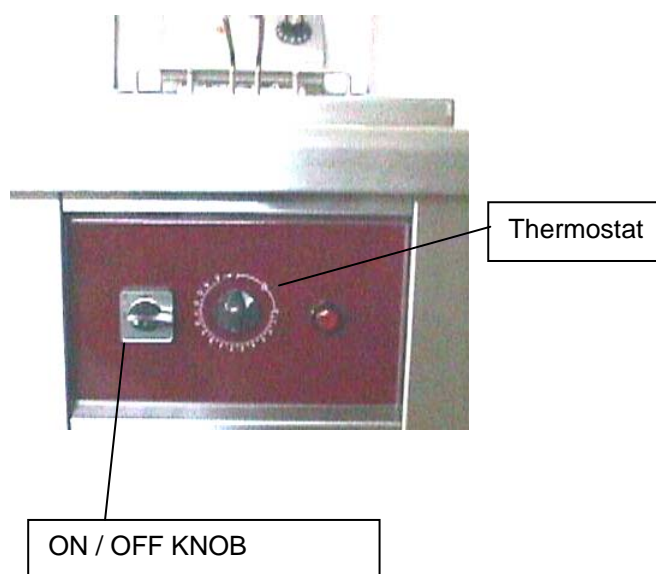

.2. Temperatures, heating up time, cooking time:

PRODUCTS	HEATING UP TIME	FRYING TEMP. IN DEG.C	COOKING TIME IN MIN.
BLANCHED POTATOES 1ST IMMERSION	5 – 5'30	150° - 170°	3 – 5
GOLDEN POTATOES 2 ND IMMERSION	5'30 – 6'30	170° - 190°	2 - 3
FRIES	6'30	190°	2 - 4
FISH	5'30 – 6'30	170° - 190°	2 - 5
MEAT	5'30 – 6'30	170° - 190°	2 - 3
DESERTS	6'	180°	2 - 5

These times are only indicative; they vary depending on the oil quality, the quantity, and the temperature of the products put into the baskets.



**Preheat the bath with solid fat bars.
Never melt solid fat bars on the elements (melt these beforehand).**

Electric deep fat fryer

Pre-heating of solid fat is done with the thermostat on low setting (60 degrees Centigrade) during the whole melting process (this is to eliminate the risk of the fat catching fire around the element and activation of the high limit thermostat).

Practical advice:

The fryer allows a great variety of frying; avoid overloading the baskets.

MODEL	LOAD IN KG FRESH FRIES	LOAD IN KG 6x6 PRE-COOKED FROZEN FRIES	NUMBER OF BASKET(S)
EFR 09	3	2.5	1

Your fryer is equipped with:

- A mechanical timer will help you to plan cooking time by programming the desired time. At the end of it a sound will inform you when to remove the basket.
- A hook to hang the basket to facilitate drainage, during cooking the basket rests on the electric element.
- A cold zone to allow the impurities to settle and not burn in the tank, resulting in a need to change the cooking oils less frequently.
- A drain tap over drip tray fitted with a filter allowing drainage of the tank as well as primary oil filtration.

The tap is fitted to the underside of the oil tank and accessible via the lower cupboard. Allow oil to cool before draining.

Attention! The sides of the tank can be very hot after prolonged and intensive use. The handles of the draining tank will also be very hot if hot oil is being drained.

.3. Switching off:

- Bring thermostat back to "0" position,
- At the end of the day switch the electricity off.

3. MAINTENANCE

.1. Cleaning the stainless steel covers:

- Use a sponge with soapy water or any other neutral cleaning agent. *Do not use bleach or any other acidic product even well diluted.*
- For the tops use if necessary a scouring pad making sure you follow the grain of the polish.
- After each cleaning rub with a greased cloth or kitchen paper.
- Finger marks be removed with a cloth dabbed in alcohol.

.2. Cleaning the tank:

- Switch off the fryer, allow the oil to cool and drain the tank. Then fill up the tank with water and a neutral cleaning agent or a product specially designed for fryers.
- Heat up at low temperature (60 deg C.).
- Switch off the apparatus again, drain and rinse the tank.



Electric deep fat fryer

ATTENTION

This apparatus must not be cleaned with mechanical water jets or be subjected to a deluge of water splashes. Your fryer is equipped with a removable element, do not immerse the block above the filling level. Before undertaking any cleaning operations make sure the apparatus is not connected.

For better service regular maintenance by qualified staff is recommended depending on the intensity of use.

6. POSSIBLE CAUSE OF BREAKDOWN

- In case of breakdown of the regulating thermostat, a limiting thermostat will control the temperature, cut the power to the elements in plenty of time, and ensure the fryer is secure.
- Contact the supplier to replace the thermostats or the elements.



Only a qualified electrician should replace the thermostats or elements.

The manufacturer and the fitter cannot be held responsible if the user neglects to ask for assistance in case of break down.

Transfer below information written on the data plate of your apparatus.

Electric deep fat fryer

CHARVET S.A.
38850 CHARAVINES

Réf.
 Code: Type:
 N°FC: Rep.

Cat.			
Gaz			
P (mbar)			
ΣQ_n (kW)			
ΣV_n (m ³ /h)			
ΣM_n (kg/h)			

U V Ip
 f Hz P kW



MADE IN FRANCE

This will help you with maintenance problems and spare parts

