



Direct Heat Electric Boiling Pan



Specification	PRO 800	PRO 900
1/2 E1MF60CD	V01694	V02521
E1MF100CD	V01695	V02063
E1MF150CD	V01696	V02003



Installation manual

CHARVET

F-38850 – CHARAVINES
Tel.: (33)-4-76-06-64-22
Fax: +33 (0) 4 76 55 78 75
Email: info@charvet.fr
Email: sav@charvet-sa-fr

NOTICE: 800-900 EN E1MF60-100 CD
ind.: A; Created on: 03/11/2011
Updated on: 10/01/2014
Code: E800N



Direct Heat Electric Boiling Pan



SUMMARY

Installation manual	1
1. INSTALLATION	3
1.1. General points	3
1.2. Handling - Installation	3
1.3. Installation	3
1.4. Data plate	4
2. POWER CONNECTION.....	4
2.1. Checks before proceeding.....	4
2.2. Power connection	4
2.3. Checks after connection	5
3. WATER CONNECTION	5
3.1. Water connection to mixer tap	5
4. BASIC SPARE PARTS LIST	6
Direct Heat Electric Boiling Pan wiring diag. 60L & 100L.....	7
Direct Heat Electric Boiling Pan wiring diag. 150L	8

1. INSTALLATION

1.1. General points

The appliance must be installed in an adequately aerated room, equipped with an air extraction system, in compliance with regulations and standards of the country of installation, and the instructions contained in this manual.

Warranty: The warranty is discussed in our sale contract.
This warranty does not cover damage due to faulty installation, misuse or inadequate maintenance.

The user's manual must be given to the user after installation.

1.2. Handling - Installation

- It is imperative to leave the appliance on its wooden pallet during the handling process until the final installation.
- Unpack and check the appliance for damage upon receipt.
- In case of damage, mark delivery note immediately and accordingly (within 48 hours); notify the carrier by registered mail with acknowledgement of receipt. Notify your installer.

1.3. Installation

Special attention must be paid to the local fire prevention regulations of the organization concerned (see [Public Access Premises]).

- The appliance must be installed under a suitable aspiration hood.
- If the appliance is to be installed against a wall or partition, near a piece of furniture or decorative borders, it is advised that these are of a fireproof material.
- If this is not the case, they must be protected by an approved fireproof, insulating material.
- If in doubt of the material, install your appliance at least 10 cm away from the surrounding surfaces.
- Remove all plastic protection.
- Install the appliance in its work place in the cooking zone, close to the gas conduit needed for operation.

	<ul style="list-style-type: none"> • Fixed appliance: Install the feet or the levelling studs (they are delivered in a separate box). Adjust height in order to level the appliance to a horizontal working plan of 900 mm. • Mobile appliance: Install the castors (they are delivered in a box kept inside the appliance). Castors with brakes must be locked when the appliance is being connected and during cooking. Fix all independent half modules against the wall.
---	--

Any maintenance or repair on an appliance must be undertaken by a qualified installer. The appliance must be isolated from the electrical supply or must be segregated (written procedures, physically) for the duration of the work.

1.4. Data plate

Each appliance has its own data plate. Transfer all the information written on the data plate to the last page of the user's manual.

This will make communication between you and your client easier and provide better service.

2. POWER

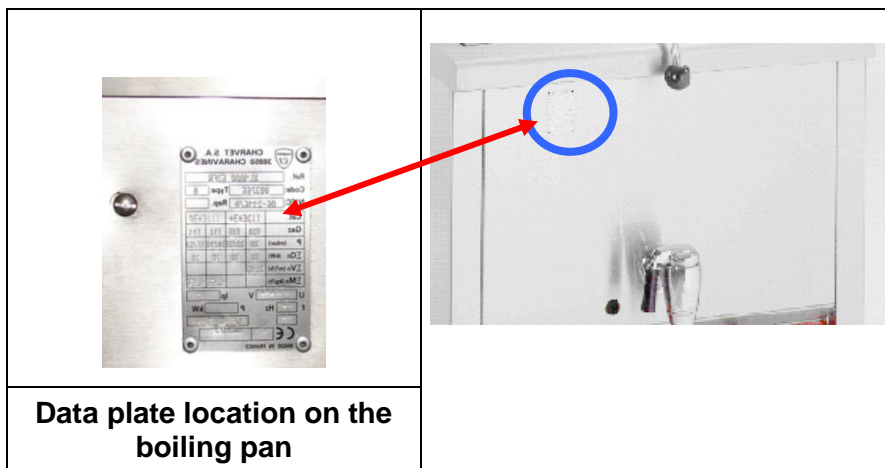

Data plate location on the boiling pan

CONNECTION

	<p>The appliance must be earth wired. It is dangerous to connect the appliance unless it is earthed. We cannot be held responsible for accidents due to non existent or incorrect earth wiring. Check that the electric network is equipped with all-pole circuit breakers having a cross section of 3.5 mm, and that it complies with the European Standard EN 60335-1 dated May 2003. All controls and checks below are done when the appliance is switched off and cold.</p>
---	--

Use a standardized cable (245 IEC 57 or 245 IEC 66) or other approved cable with the same specification.

Mobile appliances are equipped with an electrical plug of the correct wattage. The plug should be accessible at all times.

2.1. Checks before proceeding

Before connecting the appliance, check that:

- The electrical voltage of the supply is compatible with the voltage of the appliance (see data plate).
- The cable is fixed properly.
- The connections are tight enough.
- The gauge of the cable is compatible with the voltage of the appliance.

2.2. Power connection

Connect the appliance to the main electrical supply using the cable provided with the appliance.

2.3. Checks after connection

- The appliance is earth wired (see the warnings).
- The electrical equipment is well insulated.
- The appliance is in good working order (ignition, thermostat, etc.).

STARTING UP: Please see the user's manual, section "Starting up"

3. WATER CONNECTION







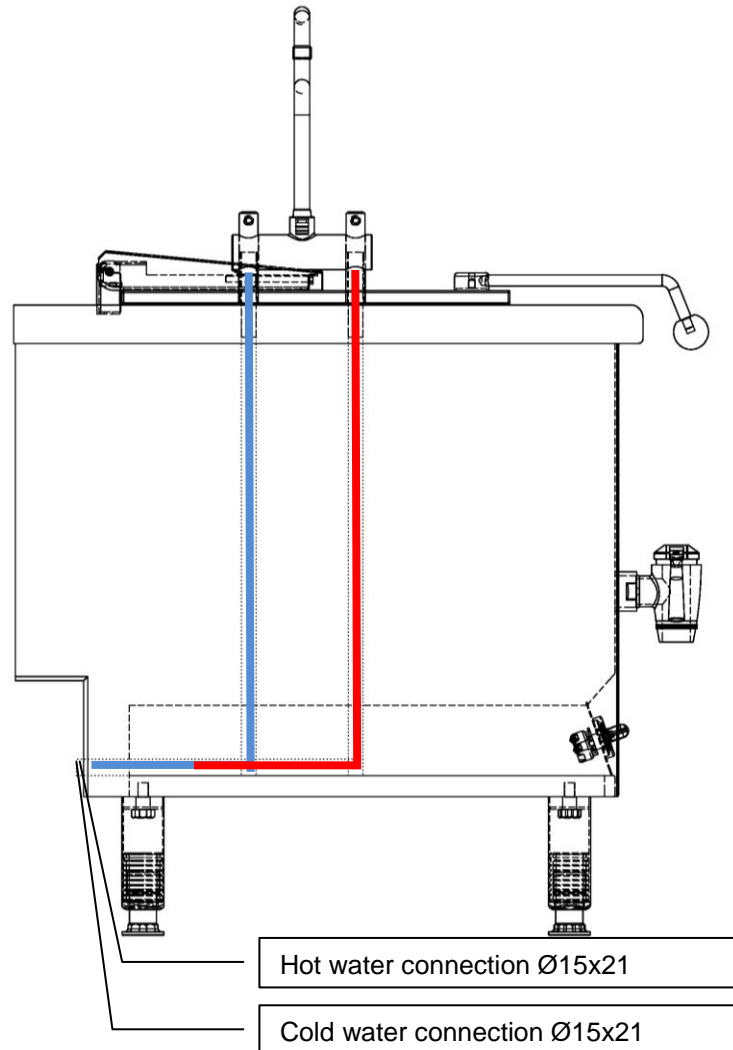

3.1. Water connection to mixer tap

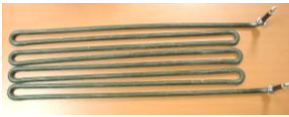
Remove the panel at the side of the mixer tap.

Connect the water supply (both hot and cold water) to the tap (M ½" Ø15 x 21).



4. BASIC SPARE PARTS LIST

Specification	Code	Photograph	Specification	Code	Photograph
Heating element for 100 L boiling pan 3600 W 230 V 05223A			Red indicator 505924 Amber indicator 505925		
Heating element for 60 L and 150 L boiling pan 3000 W 230 V 04448A			505926 White indicator		
5 A fuse 5 mm x 20 mm 03413A			Contactor 400 V 505805		
02726A Fuse-holder			Energy regulator 400V 09088A		

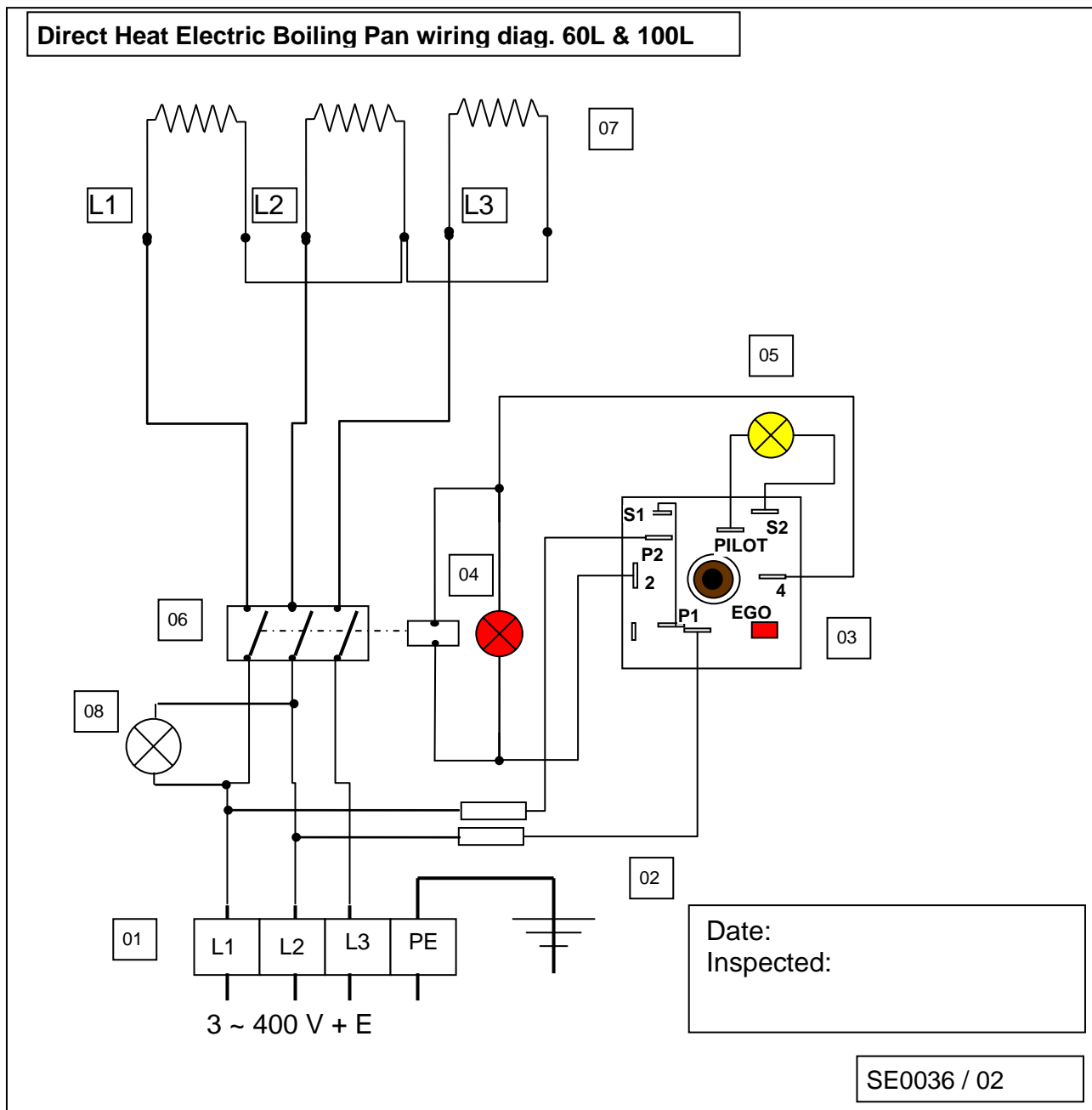

NOMENCLATURE: Boiling Pan E1MF60CD, E1MF100CD (Diagram: SE0036 / 02)

No.	Code	Specification	Quantity
01	02468A	10 m/m ² terminal (brand: Viking)	3
01	03575A	10 m/m ² green/yellow terminal (brand: Viking)	1
02	03413A	Fuse 5 mm x 20 mm, 5 A	2
02	02726A	Fuse support 5 mm x 20 mm	2
03	09088A	Energy regulator 400 V	1
04	505924	Red indicator	1
05	505925	Amber indicator	1
06	505805	Contactor	1
07	04448A	Heating element 3000 W, 230 V (60 L boiling pan)	3
07	05223A	Heating element 3600 W, 230 V (100 L boiling pan)	3
08	505926	White indicator 400V	1

CHARVET

F-38850 – CHARAVINES
 Tel.: (33)-4-76-06-64-22
 Fax: +33 (0) 4 76 55 78 75
 Email: info@charvet.fr
 Email: sav@charvet-sa-fr

NOTICE: 800-900 EN E1MF60-100 CD
 ind.: A; Created on: 03/11/2011
 Updated on: 10/01/2014
 Code: E800N

DIRECT HEAT BOILING PAN

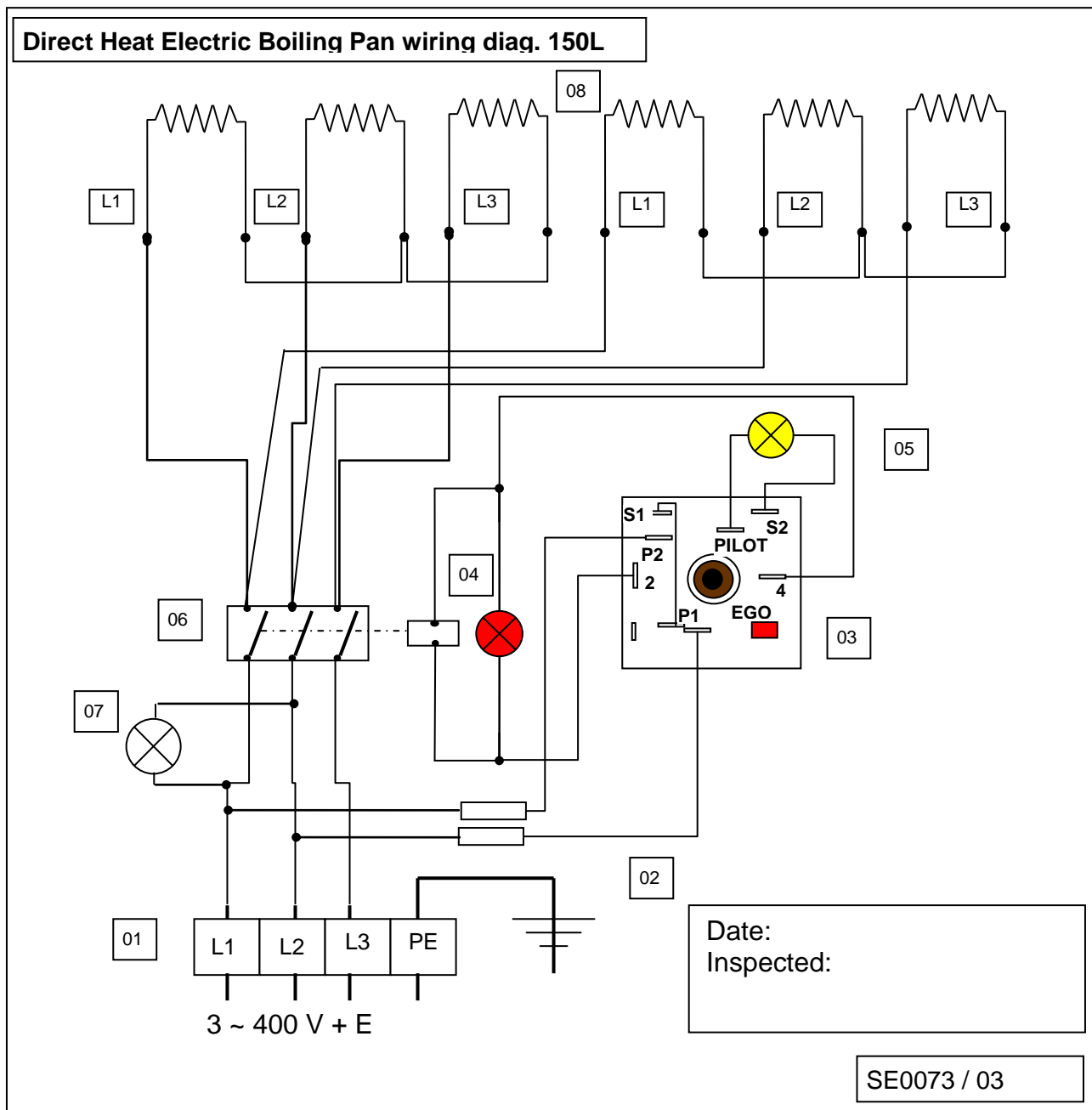

NOMENCLATURE: Boiling Pan E1MF150CD (Diagram: SE0073 / 03)

No.	Code	Specification	Quantity
01	02468A	10 mm ² terminal (brand: Viking)	3
01	03575A	10 mm ² green/yellow terminal (brand: Viking)	1
02	03413A	Fuse 5 mm x 20 mm, 5 A	2
02	02726A	Fuse support 5 mm x 20 mm	2
03	09088A	Energy regulator 400 V	1
04	505924	Red indicator	1
05	505925	Amber indicator	1
06	505805	Contactor	1
07	505926	White indicator 400V	1
08	03345A	Heating element 3000W E1MF150CD	6
08	03346A	Heating element 3500W E1MF200CD	6

CHARVET

F-38850 – CHARAVINES
 Tel.: (33)-4-76-06-64-22
 Fax: +33 (0) 4 76 55 78 75
 Email: info@charvet.fr
 Email: sav@charvet-sa-fr

NOTICE: 800-900 EN E1MF60-100 CD
 ind.: A; Created on: 03/11/2011
 Updated on: 10/01/2014
 Code: E800N



Direct Heat Electric Boiling Pan



Specification	PRO 800	PRO 900
½ E1MF60CD	V01694	V02521
E1MF100CD	V01695	V02063
E1MF150CD	V01696	V02003



User's instructions

CHARVET

F-38850 – CHARAVINES
Tel.: (33)-4-76-06-64-22
Fax: +33 (0) 4 76 55 78 75
Email: info@charvet.fr
Email: sav@charvet-sa-fr

NOTICE : 800-900 FR E1MF60-100 CD
ind. : A; Created on: 03/11/11
Updated on: 10/01/2014
Code :E800N



Direct Heat Electric Boiling Pan



SUMMARY

User's instructions	1
1. INTRODUCTION	3
2. PRIOR TO STARTING UP	3
2.1. The First Use	3
2.2. PRACTICAL ADVICE	3
3. SWITCHING OFF	5
4. MAINTENANCE	5
4.1. Cleaning of the stainless steel surfaces	5
4.2. Cleaning the tank	6
5. TROUBLESHOOTING	6

1. INTRODUCTION

- A) Our equipment is for professional use only and must be used by qualified staff.
- B) The equipment must be installed in compliance with regulations and standards in force in the country of installation, in an adequately aerated room equipped with an air extraction hood.
- C) Appliances may be installed side by side or against walls of non combustible material. Distance to combustible material shall be no less than 10 cm.
- D) It is imperative to call for a qualified engineer for all new installations or modifications of existing equipment.
- E) This instruction manual is contractual and must be given to the user after installation.
- F) **WARRANTY:** *The warranty is discussed in our sale contract. Call a registered dealer for any warranty work. This warranty does not cover damage due to faulty installation, misuse or inadequate maintenance.*

Warning:

**Do not start the appliance when the tank is empty.
Never leave appliance unattended once started.**

2. PRIOR TO STARTING UP

- a) Prior to starting up, it is advisable to clean the appliance in order to eliminate all dust and impurities that have accumulated during storage.
Fill the tank with hot water and cleaning product (1 to 2 cm).
Clean the tank with a sponge to eliminate all remaining impurities.
- b) Drain the tank by opening the front drain tap, then rinse thoroughly.

2.1. The First Use

When the appliance is switched on, the yellow indicator lights up (showing that the appliance is functioning):

- a) Set the energy regulator control knob to the 100 mark, the red indicator lights up (showing that the appliance is heating up).
- b) The appliance is heating up
- c) The appliance has reached the desired temperature when the red indicator goes out.

2.2. PRACTICAL ADVICE

Direct heat boiling pans are suitable for all types of bulk wet cooking methods (vegetables, rice, pasta, etc.).

Bain-marie boiling pans are better for wet cooking methods using sauces (stew, dairy based preparations, etc.).

Bratt pans are better for stir-fries.

CHARVET

F-38850 – CHARAVINES
Tel.: (33)-4-76-06-64-22
Fax: +33 (0) 4 76 55 78 75
Email: info@charvet.fr
Email: sav@charvet-sa-fr

NOTICE : 800-900 FR E1MF60-100 CD
ind. : A; Created on: 03/11/11
Updated on: 10/01/2014
Code :E800N

DIRECT HEAT BOILING PAN

The lid can remain open or closed according to the cooking method.

If coarse salt is used in the cooking water or in the food being cooked in the tank, it must be dissolved to avoid a deposit forming on the base.

Electronic regulation option:



Warning: the electronic regulation probe must always be completely submerged when using the boiling pan. We do not accept any responsibility if this is not adhered to.

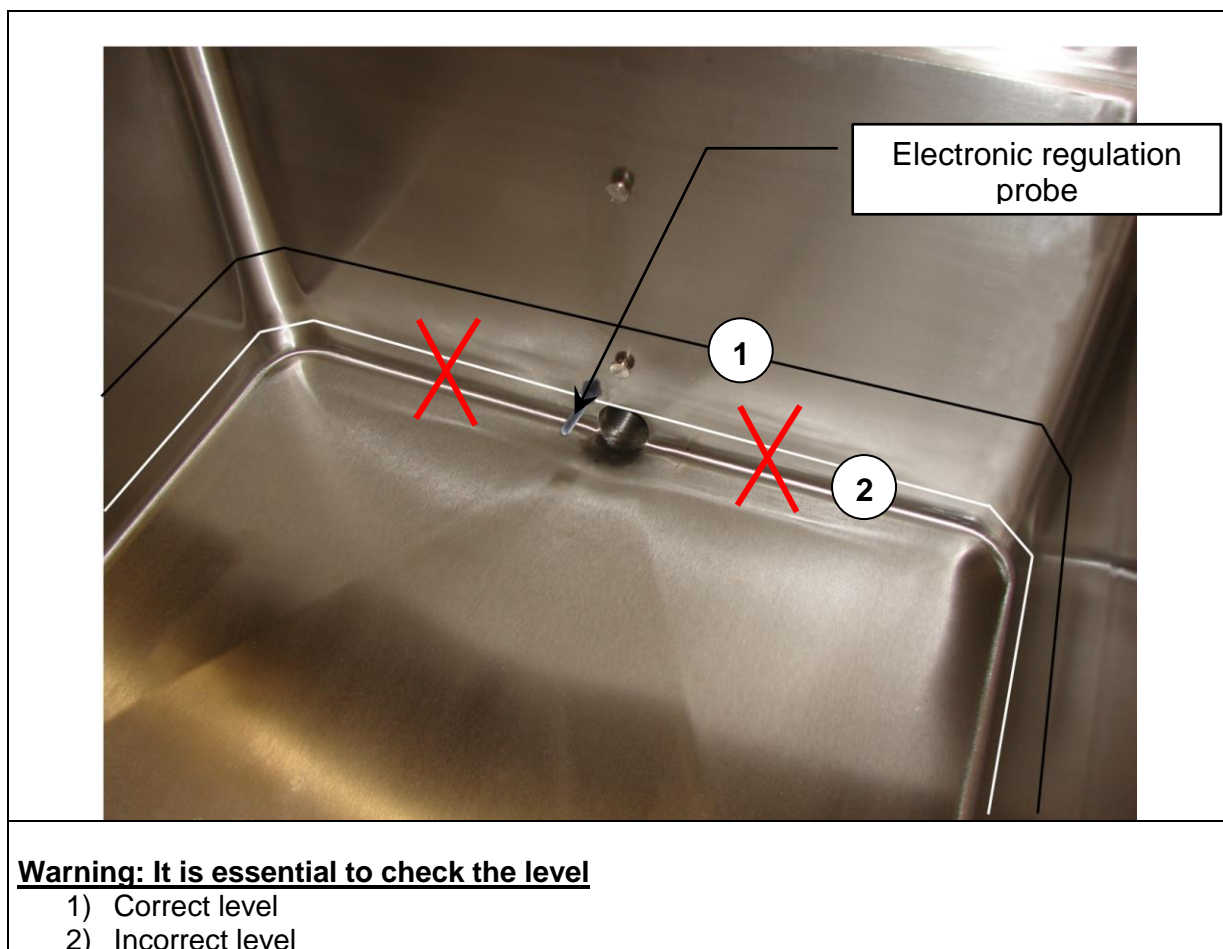

Warning:

When opening the lid during wet cooking operations, be careful of the escaping steam to avoid any risk of burns as the arm passes over the tank.

When emptying:

- ***Stay clear of the cooked product pouring zone: risk of splash burns.***

The sides of the tank, as well as the lid and body of the drain tap may be very hot after intense or prolonged use. Only move the lid or drain tap by the handles.

3. SWITCHING OFF

Empty and clean the tank after each use (to avoid all food or cleaning product residues).

At the end of the day, switch off electricity at the mains (or disconnect from the wall socket).

4. MAINTENANCE

**Our equipment must not be cleaned with water under pressure.
Check that the appliance is disconnected at the main power supply before cleaning.**

4.1. Cleaning of the stainless steel surfaces

Wash with a sponge and soapy water (or any other neutral cleaning product).

Do not use bleach or any other acidic product - even well diluted.

For the tops, use a nylon scouring pad if necessary. **Always go with the grain.**

After each cleaning, rub with an oily rag.

Finger marks can be removed with a cloth dabbed with alcohol.

- a) Switch off the appliance.
- b) Wait until the apparatus has cooled down before doing anything to it.

DIRECT HEAT BOILING PAN

4.2. Cleaning the tank

Cleaning can be done by soaking with water and liquid soap or washing-up liquid. Thoroughly rinse out the bottom of the tank with clear water to remove all salt particles. Otherwise it will corrode the stainless steel tank.

Do not use bleach or any other acidic product - even well diluted.

Rinse the tank with clear water after salty or acidic cooking.

For best results, have your equipment serviced and cleaned on a regular basis by a qualified installer.

WARNING: Certain parts of this appliance are protected by the manufacturer, and must not be handled by the installer or the user.

5. TROUBLESHOOTING

UNSATISFACTORY HEATING: Probable causes

Heating elements are cut
Energy regulator failure.

Contact the supplier to replace the faulty parts for further use.





Only a qualified electrician can replace the ignition transformers.

The manufacturer and the installer CANNOT BE HELD RESPONSIBLE if the user fails to ask for assistance in case of malfunction.

DIRECT HEAT BOILING PAN

TRANSFER the information written on the data plate of your apparatus below.

This information will help you with maintenance problems and spare parts.

		CHARVET S.A.	
		38850 CHARAVINES	
Réf.	<input type="text"/>		
Code:	<input type="text"/>	Type:	<input type="text"/>
N°FC:	<input type="text"/>		<input type="text"/>
N°OF:	<input type="text"/>	Rep.	<input type="text"/>
Cat.	<input type="text"/>	<input type="text"/>	<input type="text"/>
Gaz	<input type="text"/>	<input type="text"/>	<input type="text"/>
P (mbar)	<input type="text"/>	<input type="text"/>	<input type="text"/>
ΣQ_n (kW)	<input type="text"/>	<input type="text"/>	<input type="text"/>
ΣV_n (m ³ /h)	<input type="text"/>	<input type="text"/>	<input type="text"/>
ΣM_n (kg/h)	<input type="text"/>	<input type="text"/>	<input type="text"/>
U	<input type="text"/>	V	<input type="text"/>
		Hz Ip	<input type="text"/>
P	<input type="text"/>	kW	<input type="text"/>
		<input type="text"/>	
MADE IN FRANCE			

CHARVET

F-38850 – CHARAVINES
Tel.: (33)-4-76-06-64-22
Fax: +33 (0) 4 76 55 78 75
Email: info@charvet.fr
Email: sav@charvet-sa-fr

NOTICE : 800-900 FR E1MF60-100 CD
ind. : A; Created on: 03/11/11
Updated on: 10/01/2014
Code :E800N