

GAS SOLID TOP

Description	PRO 800 SERIES		PRO 900 SERIES	
G1PL/G2PL	V01603	V01583	V01535	V01459
B-G1PL/B-G2PL	V01605	V01585	V01538	V01462
R-G1PL/R-G2PL	V01606	V01586	V01731	V01726
1/2B-G1PL	V01928		V01953	
1/2R-G1PL	V01628		V01736	



INSTALLATION MANUAL

SUMMARY

1. INSTALLATION.....	3
1.1. GENERAL POINTS.....	3
1.2. HANDLING	3
1.3. INSTALLATION.....	3
1.4. DATA PLATE	4
1.5. FIXING THE LOW FLUE.....	4
2. GAS CONNECTIONS.....	5
2.1. CHECKS BEFORE CONNECTION	5
2.2. CONNECTING THE APPLIANCE TO THE GAS MAINS.....	6
2.3. CHECKS AFTER CONNECTION.....	7
2.4. CHECKS OF PRESSURE SUPPLY.....	7
3. CONVERSION TO OTHER TYPES OF GAS	7
3.1. CHANGING THE INJECTORS AND ADJUSTING THE AIR	7
3.2. CHANGING THE INJECTORS AND ADJUSTING AIR OF THE OVEN PILOT LIGHT.....	9
3.3. GAS ADJUSTMENT CHARTS	10
3.4. ADJUSTING THE OVEN OUTPUT.....	11
3.5. ADJUSTING THE SLOW DOWN POSITION	12
4. POWER CONNECTION	12
4.1. CHECKS BEFORE CONNECTION	12
4.2. CONNECTING THE APPLIANCE TO THE ELECTRIC NETWORK.....	13
4.3. CHECKS AFTER CONNECTION.....	13
4.4. ADAPTING THE APPLIANCE TO THE VARIOUS ELECTRICAL SUPPLY VOLTAGES	13
5. WIRING DIAGRAMS	14
6. BASIC SPARE PARTS LIST	18
7. MAINTENANCE	19
7.1. CHANGING THE SOLENOID VALVE	19

1. INSTALLATION

1.1. General points

Installation must be undertaken in compliance with the following instructions and with local codes and bylaws. Ensure you have a suitable and sufficient risk assessment in place.

This appliance is of A-type and shall not be connected to a flue gas pipe.

The user's manual must be given to the user after installation.

1.2. Handling

It is imperative to leave the appliance on its wooden pallet for handling on site until the final installation.

Unpack and check the appliance for damage upon receipt.

In case of damage, mark delivery note accordingly and immediately (within 48 hours) notify the carrier by registered mail with acknowledgement of receipt. Notify your seller.

1.3. Installation

All local fire regulations must be adhered to.

The appliance must be installed under a suitable mechanical extraction hood.

If the apparatus is to be installed against a wall or partition, near a piece of furniture or decorative borders, it is recommended that these are made of fireproof material.

If this is not the case, they must be protected by an approved fireproof, insulating material.

If in doubt of fireproof construction of adjacent walls, distance to combustible material shall be no less than 10 cm.

Remove all plastic protection. Install the appliance in the kitchen.

Warning

- **Fixed appliance:**

Check that the masonry plinth is well horizontally leveled.

Adjust height to level the unit to a horizontal working plan of 900 mm.

- **Mobile appliance:**

Install the castors (they are delivered in a box kept inside the appliance).

The castors with brakes must be locked when the appliance is being connected and during cooking times. Fix all independent half module against the wall.

- **WARNING:**

HALF MODULE UNITS: Independent half module units must be fixed to the wall.

**Any technical action on an appliance must be undertaken by a qualified technician.
The appliance will have to be isolated from the electrical supply for the duration of the work.**

When the appliance is ready for use, ensure the users know how to use it properly.
(Please see the user's manual).



Warranty: The warranty is mentioned in our conditions of sale.

This warranty does not cover damage due to faulty installation, misuse or inadequate maintenance.

1.4. **Data plate**



Each appliance has its own data plate. Transfer all the information written on the data plate to the part of the user's manual reserved for it.

This will ease the communication between you and your client for better service.

	
<p>Data plate: In cupboard / open base</p>	<p>Appliance with oven: data plate in front</p>

1.5. **Fixing the low flue**

Install the flue on top of the appliance and ensure the flue is free of obstruction (inside/outside).

<p>You have access to 2 screws located on the right and left sides of the flue (fig.1) and (fig. 2)</p>	<p>Fig.1</p> 
<p>Unscrew the screws to lower the fixing tabs (fig.3)</p>	<p>Fig. 2</p> 
<p>Install the flue above the space reserved for it and slide the fixing fasteners underneath the top of the appliance. Screw the two screws to fix the flue (see fig. 1 and fig. 2).</p>	<p>Fig. 3</p> 

2. GAS CONNECTIONS

Warnings

- **Fixed appliance:**

Connect the appliance to the gas mains using 1/2" NPT pipe and connections. Install a suitable shutoff valve (or valve + pressure regulator) in the supply line, allowing the unit to be isolated from the rest of the cooking range.

- **Mobile appliance:**

Connect a 1/2 NPT approved armoured flexible gas hose equipped with a quick disconnect fitting including automatic gas shutoff valve to the gas connection located on the rear of the appliance. (Remember to use the security chain).

2.1. Checks before connection

Check that:

- The mains should be free of obstructions, and clean.
- Ensure that the gas supply pipe is of the correct size for minimum pressure drop according to length, elbows, and total unit capacity.
- The appliance requires a fresh air input of 2m³/h/kW. (See chart below).
- The type of gas used: Ensure that the appliance is set for the type of gas supplied (nature/pressure); see data plate on the appliance and label on the gas connection.

CHART								
Code				Appliance	Power (kW)		Fresh air input required (m ³ /h/kW)	
V01603	V01583	V01535	V01459	G1PL/G2PL	23	25	46	50
V01605	V01585	V01538	V01462	B-G1PL/B-G2PL	12	14	24	28
V01606	V01586	V01731	V01726	R-G1PL/R-2PL	12	14	24	28
V01928		V01953		1/2B-G1PL	7	7	14	14
V01628		V01736		1/2R-G1PL	7	7	14	14

2.2. **Connecting the appliance to the gas mains**

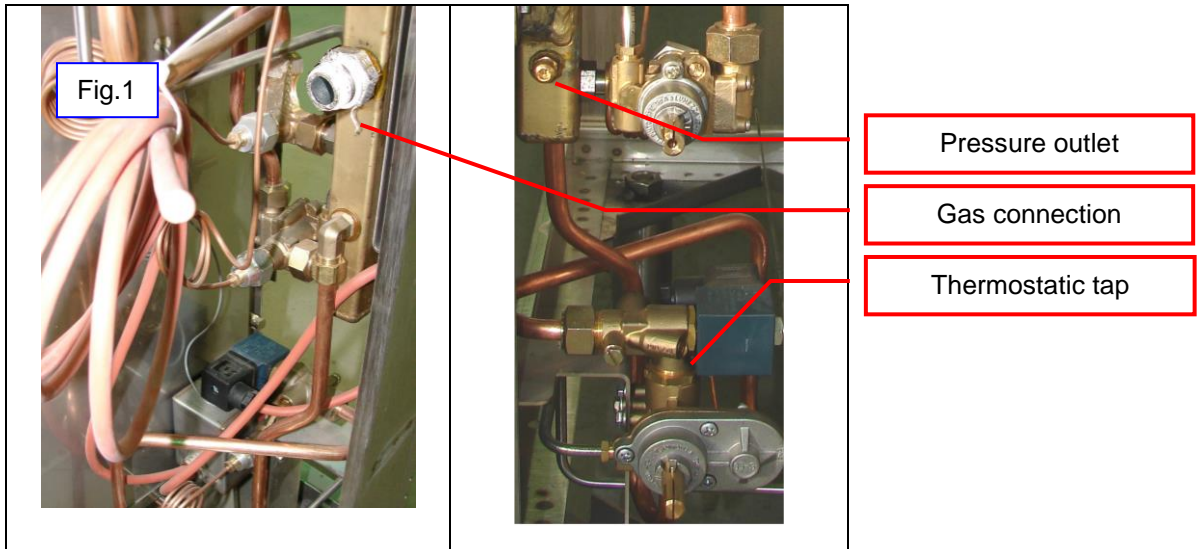

• **Appliances with oven**

- Remove the control knobs,
 - Remove the control panel (fixed with 2 screws),
 - Connect the appliance to the gas mains using 1/2" M tube (fig. 1),
- Note: The pressure tap is accessible (see § 2.4.).

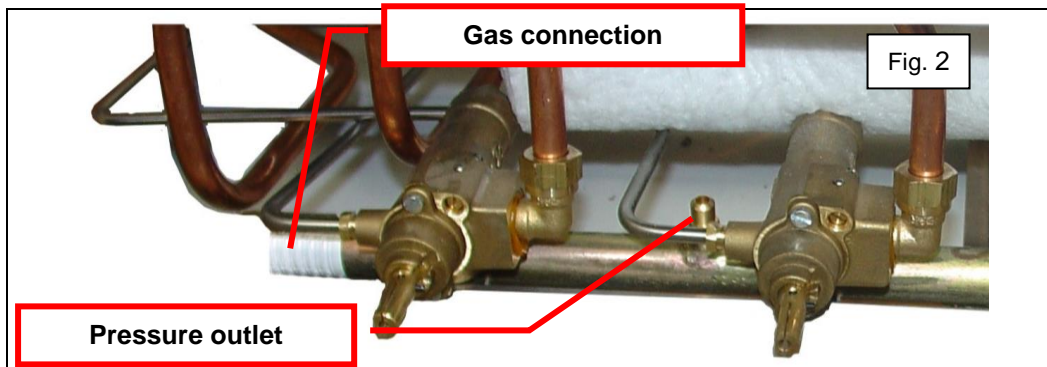

• **Appliances on open base**

- Remove the control knobs,
- Remove the control panel (fixed with 2 screws),
- Connect the appliance to the gas mains using a 1/2" M tube.

2.3. **Checks after connection**

- The water system is well watertight,
- Supply pressure of the appliance in working state,
- The colour of the flame (blue),
- The slow-down position (see § 3.4.),
- The good working state of the appliance and its safety devices.

2.4. **Checks of pressure supply**

Taking the pressure:

- Remove the control knobs,
- Remove the control panel,
- Connect the manometer on the pressure tap located on the burner ramp,
- Switch ON appliance to maximum setting,
- Then check your figures (see § 3 “Gas Adjustments”).

Note: All the appliances connected to the same gas supply should be in working state while taking the pressure supply.

3. CONVERSION TO OTHER TYPES OF GAS

Change of gas upon installation: After having replaced the injectors, ensure of the watertightness of the connection between the injector and its support.

3.1. **Changing the injectors and adjusting the air**

See charts § 3.3. according to the type of burners.

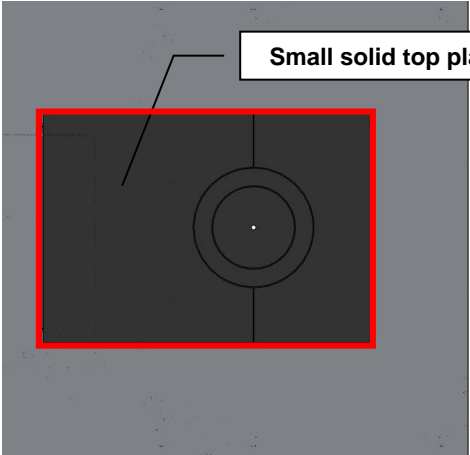
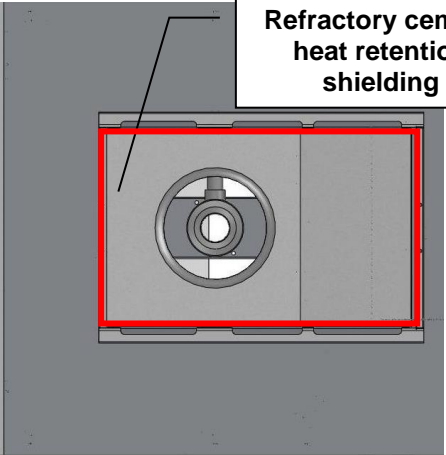
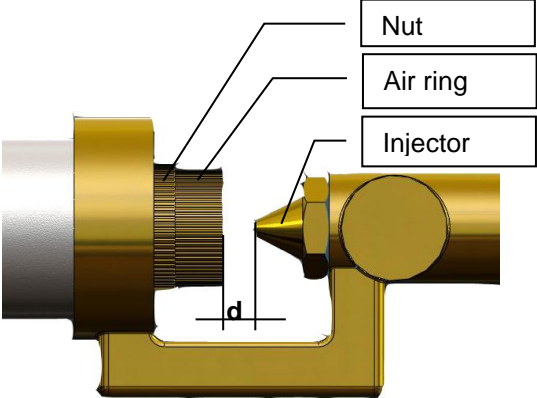
 <p>Small solid top plate</p>	 <p>Refractory cement heat retention shielding</p>
<p>Full module unit G-PL</p> <ul style="list-style-type: none"> - Remove the solid top and refractory cement heat retention shielding to access the venturi, - Unlock the air ring (3), nut (/ring), - Change the injector (1) (ring spanner 17mm) See chart A § 3.3. - Adjust distance "d", and lock. (nut/ring), then adjust and seal. 	 <p>Nut</p> <p>Air ring</p> <p>Injector</p> <p>d</p>

FULL MODULE UNIT Gas oven

- Remove the mild steel base to access the venturi,
- You can reach the air ring and injector
- Unlock the air ring (nut/ring)
- Change the injector (ring spanner 12mm),
See chart § 3.3.
- Adjust distance "d", and lock. (nut/ring), then adjust and seal.

3.2. Changing the injectors and adjusting air of the oven pilot light

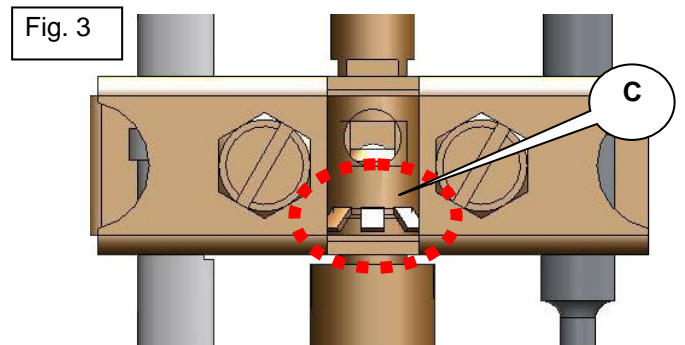
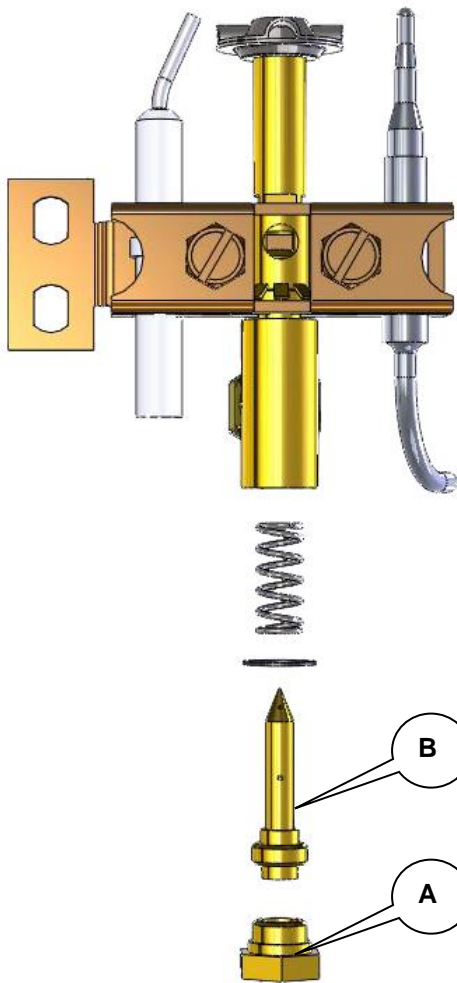

Remove the mild steel base.
 Unscrew the nut (A) with an open-end spanner 11mm,
 Change the injector (B); see chart § 3.3.
 Adjustment of air ring (Fig. 3 (C)); see chart § 3.3.

Check the watertightness of the gas pipe and the good working condition of the pilot light.

3.3. Gas adjustment charts

Large solid top plate

Air	Gas type & operating pressure	Mark engraved on the injector	Air adjustment d (mm)*2	Nominal calorific output (kW)*1
1	G20: Pn = 20 mbar	250	10	12
2	G 25: Pn = 20 mbar			
3	G 25: Pn = 25 mbar			
4	G 30: Pn = 29 mbar	180	10	
5	G 30: Pn = 50 mbar			
6	G 31: Pn = 37 mbar			
7	G 31: Pn = 50 mbar			
8	G 110: Pn = 8 mbar			
9	G 120: Pn = 8 mbar			

Small solid top plate

Air	Gas type & operating pressure	Mark engraved on the injector	Air adjustment d (mm)*2	Nominal calorific output (kW)*1
1	G20: Pn = 20 mbar	190	3	7
2	G 25: Pn = 20 mbar			
3	G 25: Pn = 25 mbar			
4	G 30: Pn = 29 mbar	130	15	
5	G 30: Pn = 50 mbar			
6	G 31: Pn = 37 mbar			
7	G 31: Pn = 50 mbar			
8	G 110: Pn = 8 mbar			
9	G 120: Pn = 8 mbar			

Oven

Air	Gas type & operating pressure	Mark engraved on the injector	Air adjustment d (mm)*2	Nominal calorific output (kW)*1
1	G20: Pn = 20 mbar	250	2	11
2	G 25: Pn = 20 mbar			
3	G 25: Pn = 25 mbar			
4	G 30: Pn = 29 mbar	165	4	
5	G 30: Pn = 50 mbar			
6	G 31: Pn = 37 mbar			
7	G 31: Pn = 50 mbar			
8	G 110: Pn = 8 mbar			
9	G 120: Pn = 8 mbar			

- 1 Measured power over lower calorific power of the gas (HI) for burner.
- 2 Adjustment of measured primary air according to fig. 2

Pilot lights

SOLID TOP / OVEN			
Air	Gas type & operating pressure	Mark engraved on the injector	Air adjustment
1	G20: Pn = 20 mbar	40	Open ring
2	G 25: Pn = 20 mbar		
3	G 25: Pn = 25 mbar		
4	G 30: Pn = 29 mbar	20	Open ring
5	G 30: Pn = 50 mbar		
6	G 31: Pn = 37 mbar		
7	G 31: Pn = 50 mbar		
8	G 110: Pn = 8 mbar		
9	G 120: Pn = 8 mbar		

3.4. **Adjusting the oven output**

Output adjustment is done in factory (Thermostatic control)
 Only qualified staff can do the adjustment.
 It could be necessary to adjust it.

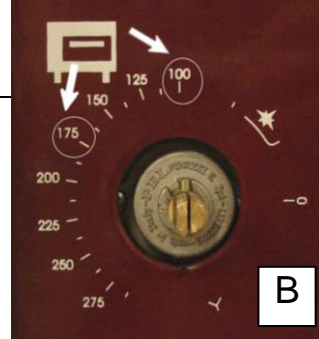
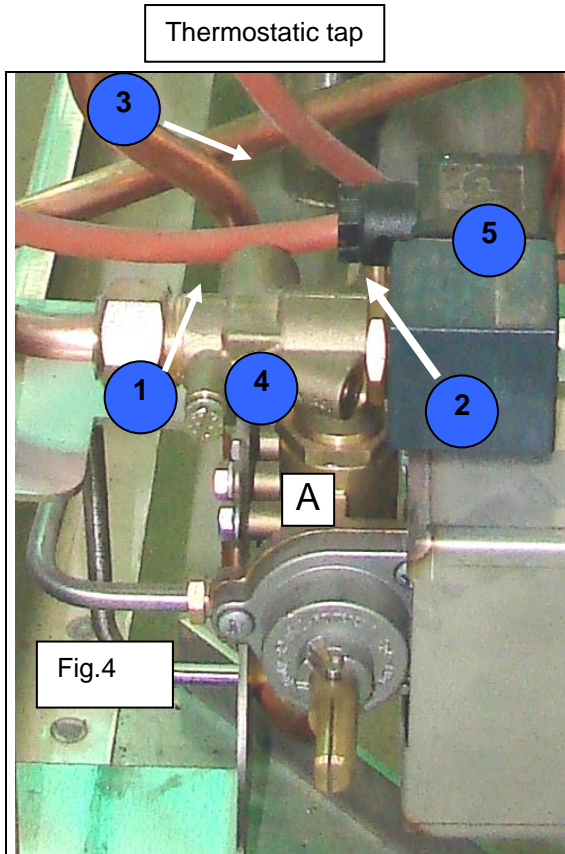

This operation must be carried out very quickly and before the thermostat responds and the burner turns to the maxi output position.
 Note: The maximum output position reduces flames to 1/4 of their size. The burner must remain alight when proceeding from the maximum output position to the minimum output position.

- 1) Pressure tap
- 2) Min. output screw
- 3) Max. output screw
- 4) Thermostatic control

• **Adjusting the oven slow-down position**

Remove the control panel (see "Gas connection" § 2.2.).
 Refit the control knob (A).
 Ignite the burner and preheat for 15mn about with the door closed.
 Thermostatic control in position 3-4 then in position 1 (Fig. B). Screw (3) to reduce output and unscrew to increase it.
 Screw (2) to reduce output and unscrew to increase it.
 Pressure can be measured from the pressure outlet (1) (Fig. 4).

3.5. Adjusting the slow down position

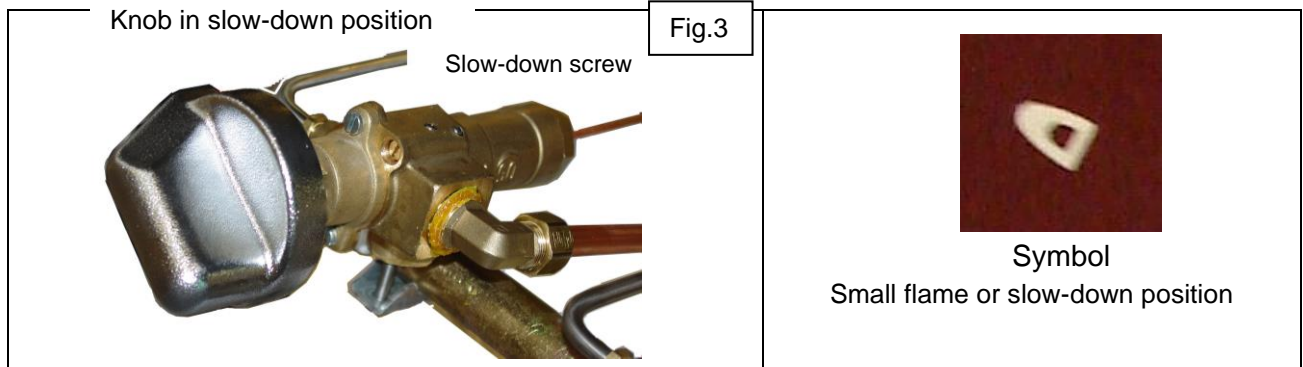

• **Adjusting the slow-down position of the burner**

Remove the control knobs,
 Remove the control panel,
 (see § 2.2. – gas connections)
 Refit in place the control knob
 Switch ON the appliance. (See the user's manual, § 3).
 Set control knob to the slow-down position (fig. 3)
 Adjust the screw.
 To increase the slow-down position, unscrew the screw (fig. 3)
 Note: The burner must remain alight when changing from maximum output to minimum output.

4. POWER CONNECTION



Warnings:

The appliance must be earth wired.
It is dangerous to connect the appliance unless it is earthed.
We cannot be held responsible for accidents due to non existent or incorrect earth link connection.

Fixed appliance:
 Check that the electric network is equipped with all-pole circuit breakers having a cross section of 3.5 mm at least. All electrical equipment must be in compliance with the standard EN 60335-1.

WARNING:
 Use a standardized cable (245 IEC 57 or 245 IEC 66) or other approved cable with the same characteristics.

All controls and checks below are done when the appliance is switched off and cold.

4.1. Checks before connection

Check that:

- The electrical voltage of the supply is compatible with the voltage of the apparatus (see data plate and § 5).
- The cable is fixed properly,
- The connections are tight enough,
- The section of the cable is of correct size according to the voltage of the apparatus.

4.2. **Connecting the appliance to the electric network**

Electric ignition

Unscrew the front control panel to access the connection box, (see § “Gas connection” Fig. A).
 Thread cable through the terminal box (fixed with 2 screws).
 Connect cable to the terminals, and follow the information written on the terminal box.
 Before reassembling the parts, check the electrical equipment is properly insulated (cable).

Note: The ignition push buttons and indicators should remain in place.

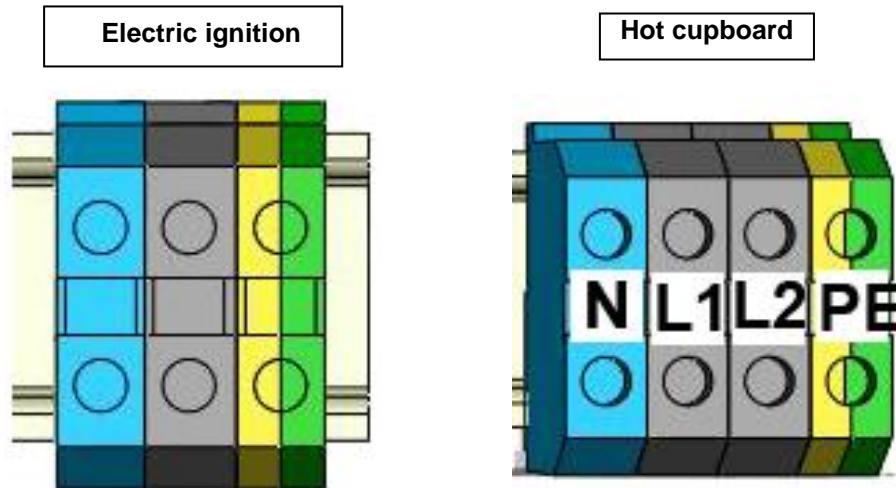

4.3. **Checks after connection**

- The appliance is earth wired (see the warnings)
- The electric equipment is well isolated from the rest of the equipment,
- The appliance is in good working order (ignition, thermostat, etc.).

STARTING UP: Please see the user’s manual, section “Starting up”

4.4. **Adapting the appliance to the various electrical supply voltages**

Voltages available				
Voltage of appliance		1~230V + E	3~230V + E	3~400V + E
	Wiring diagrams #	S = standard coupling		
Electric ignition	SE0001/00	S	A	A
Electric hot cupboard GN1/1	SE0005/00	S	A	A
Electric hot cupboard GN2/1	SE0006/00	A	A	S
Thermostatic Tap	SE0117/00	S	A	A
A → Coupling possible B → Please consult Charvet C → Coupling impossible D → No voltage available				

5. WIRING DIAGRAMS

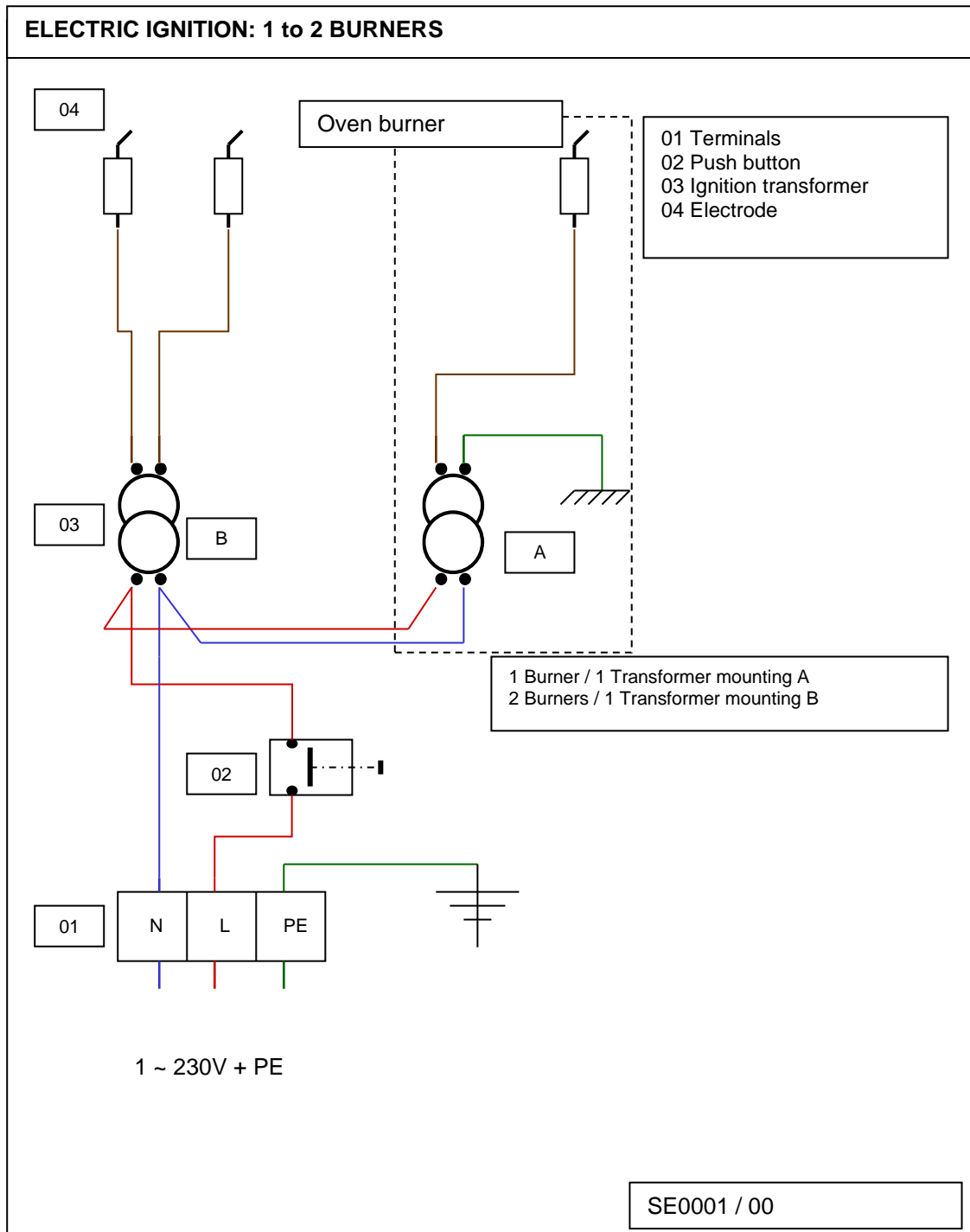

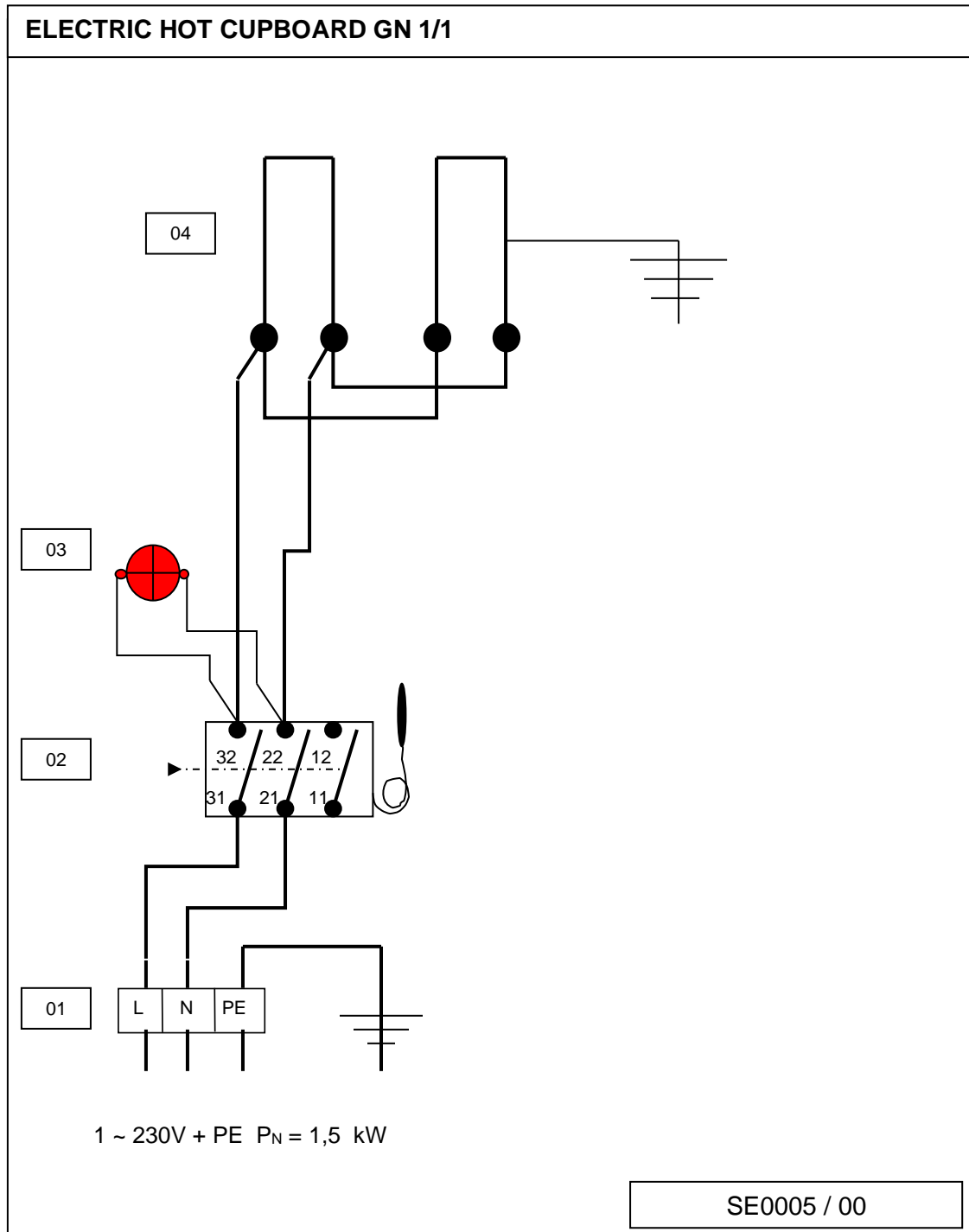

NOMENCLATURE: ELECTRIC HOT CUPBOARD GN1/1 (SE0005 / 00)

Mark	Code	Description	Quantity
01	02468A	10 mm ² terminal (brand: Viking)	1
01	07069A	Blue terminal Vicking	1
01	03575A	Earth terminal (brand: Viking)	1
02	01995A	Thermostat	1
03	173639	Red indicator 230 V	1
04	02060A	Pin heating elements – 750 W, 230 V	2

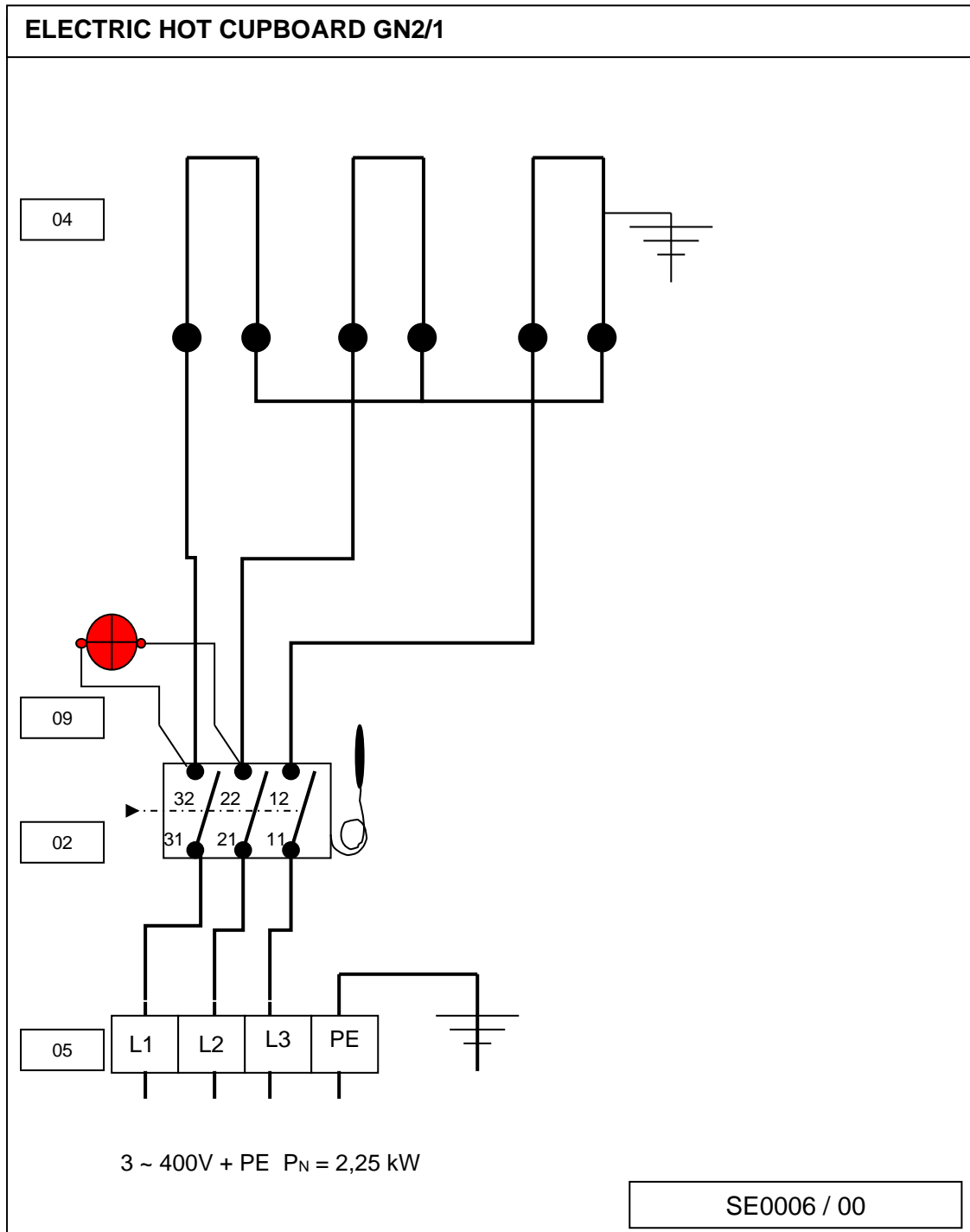

NOMENCLATURE: ELECTRIC HOT CUPBOARD 800 mm x 600 mm (diagram: SE0006 / 00)



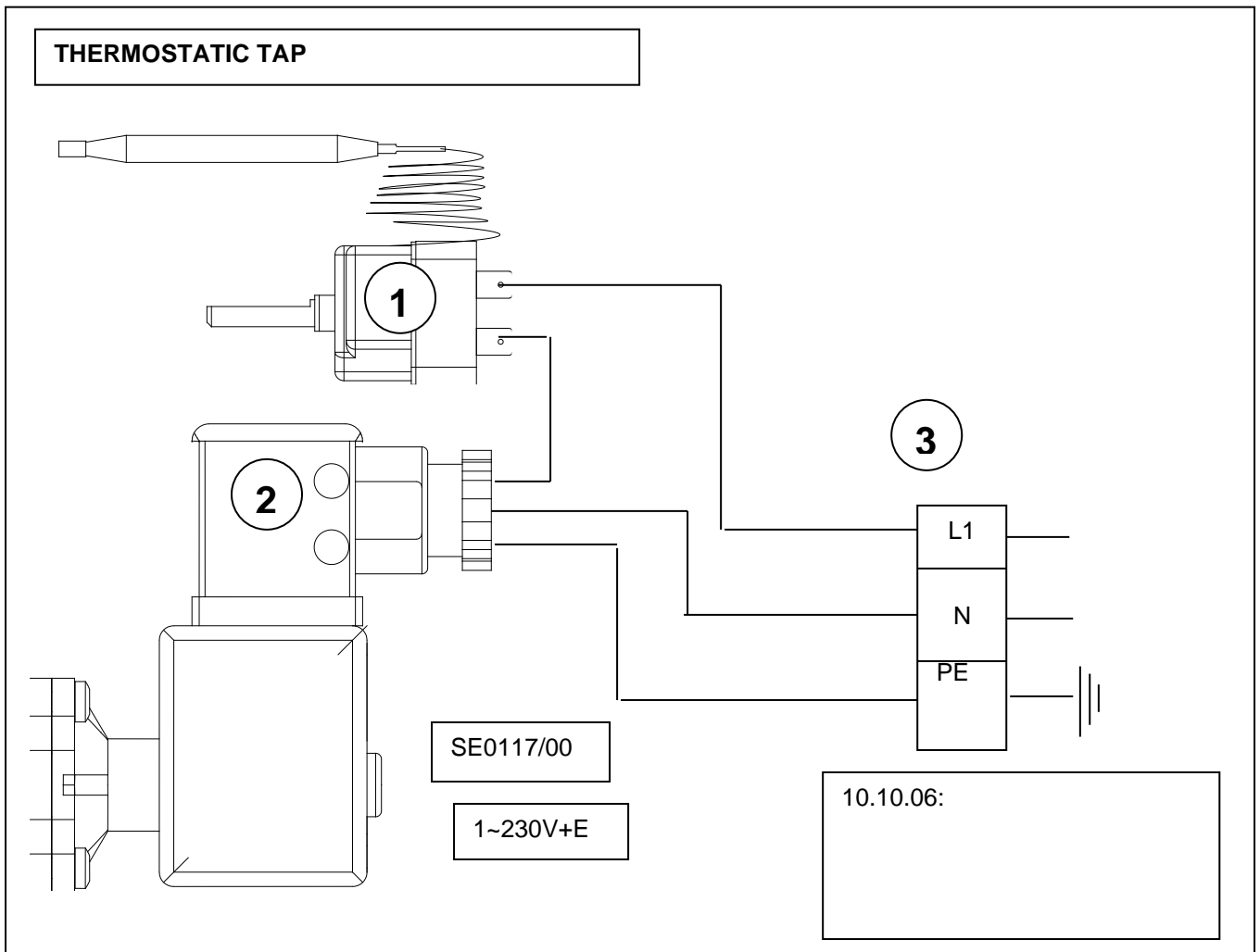







Mark	Code	Description	Quantity
01	02468A	10 mm ² terminal (brand : Viking)	3
01	03575A	Earth terminal (brand: Viking)	1
02	01995A	Thermostat	1
03	173639	Red indicator 400 V	1
04	02060A	Pin heating element – 750 W, 230 V	3









NOMENCLATURE: THERMOSTATIC CONTROL (SE0117/00)

Mark	Code	Description	Quantity
01	502002	Thermostat	1
02	08425A	Solenoid valve	1
03	02468A	Terminal	1

6. BASIC SPARE PARTS LIST

Description / Code	Photograph	Description / Code	Photograph
Gas tap 00311A		Thermostatic control 08425A	
Gas injector Solid top G20/G25 Ø 2.50 Natural 00209A G31 Ø 1.80 Propane 00202A		Gas injector oven G20/G25 Ø 2.50 Natural 00209A G31 Ø 1.65 Propane 00562A	
Thermocouple 00290A		3-flame pilot light 07551A natural 07550A propane	
Thermocouple coil (gas tap) 00325A		Pilot light injector oven G30, G31 Ø 0.20 Propane 07357A G20/G25 06430A Ø 0.40 natural	
Whole burner for cast iron solid top F13087		Enameled oven burner F04506 F10115 (complet)	
Red indicator 400V 173644 230V 173639		Push button for ignition Ele0018	
thermostatic control coil 08936A		Electric ignitor 240V - 02161A	
Hot cupboard pin heating element 230V, 750W 02060A		Electrode 05315A	

<p>Tripolar thermostat Hot cupboard 30-110° 01995A</p>		<p>Oven thermostat 350°C 502002</p>	
<p>Central ring Small solid top plate 05192A</p>		<p>Ring set for the large solid top plate 05213A</p>	
<p>Small solid top plate 600 x 422 mm 05165A</p>		<p>Solid top plate 600 x 841 mm 02926A</p>	

7. MAINTENANCE

7.1. Changing the solenoid valve

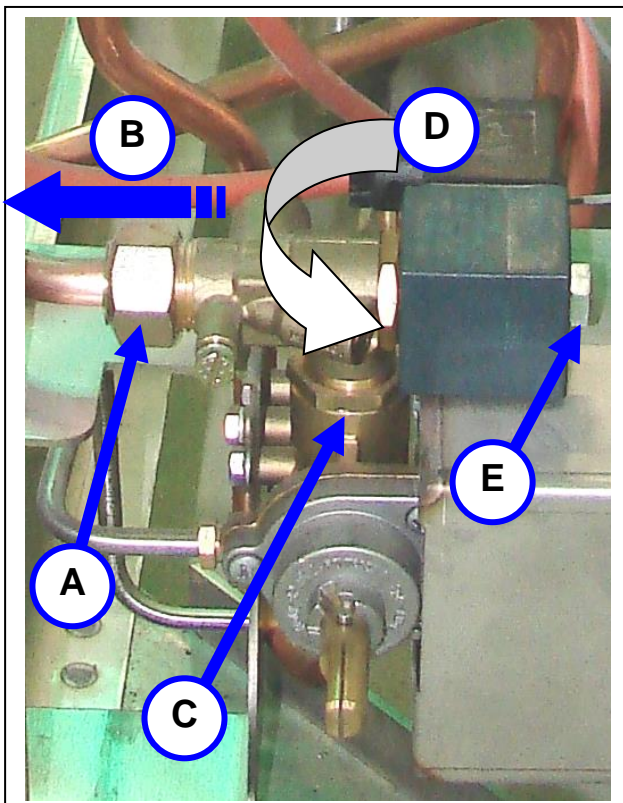

- Changing the solenoid valve
(A) Unscrew the nut and pull the copper pipe (B) to the left very carefully. Unscrew the nut (C), swivel (D) and unscrew the nut (E) to remove the solenoid valve.

GAS SOLID TOP

Description	PRO 800 SERIES		PRO 900 SERIES	
G1PL/G2PL	V01603	V01583	V01535	V01459
B-G1PL/B-G2PL	V01605	V01585	V01538	V01462
R-G1PL/R-G2PL	V01606	V01586	V01731	V01726
1/2B-G1PL	V01928		V01953	
1/2R-G1PL	V01628		V01736	



USER'S INSTRUCTIONS

SUMMARY

1. INSTALLATION	3
1.1. GENERAL POINTS.....	3
1.2. HANDLING	3
1.3. INSTALLATION.....	3
1.4. DATA PLATE.....	4
1.5. FIXING THE LOW FLUE	4
2. GAS CONNECTIONS.....	5
2.1. CHECKS BEFORE CONNECTION	5
2.2. CONNECTING THE APPLIANCE TO THE GAS MAINS.....	6
2.3. CHECKS AFTER CONNECTION	7
2.4. CHECKS OF PRESSURE SUPPLY	7
3. CONVERSION TO OTHER TYPES OF GAS.....	7
3.1. CHANGING THE INJECTORS AND ADJUSTING THE AIR.....	7
3.2. CHANGING THE INJECTORS AND ADJUSTING AIR OF THE OVEN PILOT LIGHT.....	9
3.3. GAS ADJUSTMENT CHARTS.....	10
3.4. ADJUSTING THE OVEN OUTPUT	11
3.5. ADJUSTING THE SLOW DOWN POSITION.....	11
4. POWER CONNECTION	12
4.1. CHECKS BEFORE CONNECTION	12
4.2. CONNECTING THE APPLIANCE TO THE ELECTRIC NETWORK	13
4.3. CHECKS AFTER CONNECTION	13
4.4. ADAPTING THE APPLIANCE TO THE VARIOUS ELECTRICAL SUPPLY VOLTAGES.....	13
5. WIRING DIAGRAMS.....	14
ELECTRIC IGNITION: 1 TO 2 BURNERS.....	14
<i>Quantity.....</i>	<i>15</i>
6. BASIC SPARE PARTS LIST	18
7. MAINTENANCE	19
7.1. CHANGING THE SOLENOID VALVE	19
1. INTRODUCTION.....	4
2. PRIOR TO STARTING UP	4
3. STARTING UP	5
3.1. SOLID TOP PLATE.....	5
3.2. OVEN.....	5
3.3. ELECTRIC HOT CUPBOARD.....	5
4. SWITCHING OFF	6
5. MAINTENANCE	6
5.1. CLEANING THE STAINLESS STEEL SURFACES	6
5.2. CLEANING THE SOLID TOP PLATE	6
5.3. CLEANING THE OVEN	6
5.4. CLEANING OF THE MILD STEEL BASE, OVEN SHELF AND SHELF RUNNER	7
6. IN CASE OF BREAKDOWN	8
6.1. UNSATISFACTORY HEATING	8
6.2. FAULTY IGNITION	8

1. INTRODUCTION

- A) Our equipment is for professional use only and must be used by qualified staff.
- B) The equipment must be installed in compliance with local codes and bylaws. It must be installed in a kitchen equipped with an adequately sized mechanical extraction system.
- C) Appliances may be installed side by side or against walls of non combustible material. Distance to combustible material shall be no less than 10 cm.
- D) It is imperative to call for a qualified engineer for all new installations or modifications of existing equipment.
- E) *WARRANTY: The warranty is mentioned in our conditions of sale. Only a qualified engineer certifies the validity of the warranty. This warranty does not cover damage due to faulty installation, misuse or inadequate maintenance.*

2. PRIOR TO STARTING UP

- a) Prior to starting up, it is advisable to clean the appliance in order to eliminate all dust and impurities that have accumulated during storage.
- b) Remove all plastic protection that wraps the stainless steel panels.
- c) Make sure that all controls are in good working condition before turning the gas on. We recommend ovens are run empty for 1 or hours to avoid an unpleasant taste of new material in food.

3. STARTING UP

General points: Each burner is equipped with a safety thermocouple and a pilot light.

3.1. Solid top plate

Take off the central ring.

Push and turn the control knob counter-clockwise of desired burner (fig. 1, mark "P") until the spark symbol.

Keep pushing thoroughly while presenting a flame or pressing the ignition push button (if fitted).

Keep the control knob pressed for 20 seconds about before releasing it.

The pilot light must remain ignited. Repeat the operation if it fails.

When the pilot light is on, turn the control knob counter-clockwise to the desired position (large flame symbol); the burner is running at full power.

By turning the control knob to the next position (small flame symbol), the burner is on the slow-down position (simmering position).

When done, refit the central ring.

3.2. Oven

Check that you can reach the pilot light through the oblong hole located at the front left hand side of the mild base (above the pilot light).

Push and turn the control knob counter-clockwise of desired burner (fig. 1, mark "F") until the spark symbol.

Keep pushing thoroughly while presenting a flame through the mild steel base hole or pressing the ignition push button (if fitted).

Keep the control knob pressed for 5 to 15 sec. before releasing it.

The pilot light must remain ignited. Repeat the operation if it fails.

When the pilot light is on, turn the control knob counter-clockwise to the desired position (large flame symbol).

Turn the thermostat control knob (Figure 1, mark T) to the desired temperature; the oven burner is working at its full power.

Close the oven door.

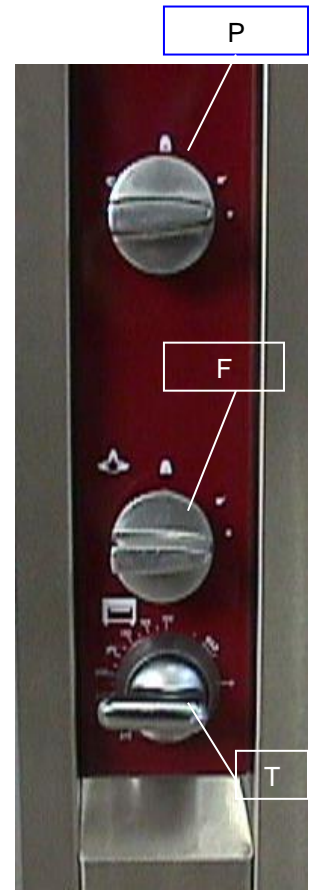

Figure 1

TEMPERATURES, RECOMMENDED PREHEATING TIMES, TYPES OF COOKING*

Thermostat settings	PREHEATING TIMES	PRODUCTS
80°C - 100°C	20"	Holding temperature
120°C - 140°C	30" - 40"	Pastry
150°C - 170°C	1' - 1'30	FISH
190°C - 220°C	2' - 3'	WHITE MEATS
240°C - 260°C	4' - 6'	Gratins
270°C - 310°C	7' - 9'	RED MEATS

This information is purely indicative.

3.3. Electric hot cupboard

The appliance is ON.

Turn the regulation thermostat knob to the desired temperature.

The red indicator remains illuminated until the desired temperature is reached.



WARNING:

When opening the oven door in “wet” cooking mode, stay clear from the oven as vapours can escape and burn your skin very seriously!

Side panels and oven door may be extremely hot after a prolonged or intensive use. Be careful to open the door only with the handle.

4. SWITCHING OFF

Turn control knobs and oven thermostat to the “STOP” position λ.
 Before doing anything on the appliance, wait until cooking areas has cooled down.
 Clean the oven grid and the solid top plate(s) after each use.
 (to remove all residues and liquids, and avoid rusting).

At the end of the day, switch off electricity at the mains.

5. MAINTENANCE**5.1. Cleaning the stainless steel surfaces**

- a) Switch off the appliance,
- b) Wait until the apparatus has cooled down before doing anything on it,
 Wash with a sponge in soapy water (or any other neutral cleaning product).
Do not use bleach or any other acidic product – even well diluted.
 For the tops, use a nylon scouring pad if necessary. Always go with the grain.
 After each cleaning, rub with a greased cloth or kitchen paper.
 Finger marks can be removed with a cloth dabbed with alcohol.

5.2. Cleaning the solid top plate

Clean with an appropriate scouring pad. Grease the cast-iron plate(s) if you don't use the appliance.
 Remove the solid top plate(s) to clean the refractory cement heat retention shielding.
 The drip tray should be cleaned daily.
 Refit in order all the parts.



Warning: Clean the solid top with a Tampico brush or a wood spatula. Never clean the cast iron solid top plate with ice.
 Dry the cast iron solid top plate carefully to avoid rusting. Then clean with a greasy cloth.

5.3. Cleaning the oven

To avoid fumes due to greases, stains and food particles, we recommend you to clean all the oven internal sides every day.
 The mild steel base can be removed to be cleaned. The burner housing can be cleaned as well (See § 4.2.1).
 The shelf runners can also be removed to be cleaned (See § 4.2.1).
 Wash the oven with a sponge in soapy water (or any other neutral cleaning product).
 After cleaning, rinse and dry all the parts carefully.
 Refit in order all the parts.

**This appliance must not be cleaned with mechanical water jets or be subject to a deluge of water under pressure.
 Check that the appliance is well disconnected at the mains.**

5.4. Cleaning of the mild steel base, oven shelf and shelf runner



- Process: disassembly and reassembly of mild steel base and shelf runners

- A) Pull out the grid towards you.
 B) Pull out the mild steel base by using the oblong-shaped hole.
 C) 1 et 2 : Lift the shelf runner, then pull it out to the left
 3: Pull out the shelf runner towards you.

The mild steel base is very heavy. Handle with care.
 Weight: 23 Kg

For best results, have your equipment serviced and cleaned on a regular basis by a qualified installer.

WARNING: Certain parts of this appliance are protected by the manufacturer, and must not be handled by the installer or the user.

6. IN CASE OF BREAKDOWN

6.1. UNSATISFACTORY HEATING

Probable causes

Clogging of the burners, injectors, etc.
Incorrect gas pressure.
Incorrect grading of the injectors.
Clogging of the rear internal flue box (solid top plate(s), oven).
Incorrect oven temperature: Faulty thermostat.

6.2. FAULTY IGNITION

Clogging of the pilot lights,
Clogging of the thermocouples,
Smashed thermocouple, incorrect pilot light output, incorrect pilot light positioning, insufficient pressure on control button.
Faulty electric ignition (option)
Call for your installer to replace the faulty electric components in preparation for a next use.



Only a qualified electrician can replace the ignition transformers.

The manufacturer and the installer cannot be held responsible if the user neglects to ask for assistance in case of breakdown.

TRANSFER below information written on the data plate of your appliance.

This will help you with maintenance problems and spare parts.

Erreur ! Nom de fichier incorrect.