



SOLID TOPS / ELECTRIC OVEN



Description	PRO 800	PRO 900
M1PL	V01604	V01536
M2PL	V01584	V01460



INSTALLATION MANUAL





SOLID TOPS / ELECTRIC OVEN



SUMMARY

INSTALLATION MANUAL	1
1. INSTALLATION	3
1.1. General points	3
1.2. Handling	3
1.3. Installation	3
1.4. Fixing the flue	3
1.5. Gas connections	4
1.6. Power connection	4
2. CONVERSION TO OTHER TYPES OF GAS	5
2.1. Changing the injectors	5
2.1.1. Large solid top plate	5
2.1.2. Small solid top plate	6
2.1.3. Pilot lights	6
2.2. Adjusting the air	6
2.3. Checks before connecting electrically the apparatus	7
2.3.1. Adjustments	7
2.3.2. Starting up	7
3. SERVICING	8
4. BASIC SPARE PARTS LIST	10
5. WIRING DIAGRAMS	12





SOLID TOPS / ELECTRIC OVEN



1. INSTALLATION

1.1. General points

Installation must be undertaken in compliance with the following instructions and with local codes and bylaws. Ensure you have a suitable and sufficient risk assessment in place.

The user's manual must be given to the user after installation.

1.2. Handling

It is imperative to leave the appliance on its wooden pallet for handling on site until the final installation.

Unpack and check the appliance for damage upon receipt.

In case of damage, mark delivery note accordingly and immediately (within 48 hours) notify the carrier by registered mail with acknowledgement of receipt. Notify your installer.

1.3. Installation

SEE technical sheets.

The appliance must be installed under a suitable mechanical extraction hood, close to the electric supply.

If the apparatus is to be installed against a wall or partition, near a piece of furniture or decorative borders, it is recommended that these are made of fireproof material.

If this is not the case, they must be protected by an approved fireproof, insulating material.

All local fire regulations must be adhered to.

If in doubt of fireproof construction of adjacent walls, distance to combustible material shall be no less than 10 cm.

- Remove all plastic protection.

Install the flue on top of the appliance and ensure the flue is free of obstruction.

- **Fixed appliance:**
 - Install the feet (they are delivered in a box kept inside the appliance).
 - Adjust height to level the unit to a horizontal working plan of 900 mm.
- **Mobile appliance:**
 - Install the appliance close to the gas mains.

IMPORTANT: *The castors with brakes must be locked when the appliance is being connected and during cooking times. Fix all independent half module against the wall.*

1.4. Fixing the flue

Unscrew the screws to lower the fixing tabs.

Help yourself with an appropriate tool to push the fixing tabs.

Tighten the screws of the flue cover.



SOLID TOPS / ELECTRIC OVEN



1.5. Gas connections

Installation must be undertaken in compliance with the following instructions and with local codes and bylaws. Ensure you have a suitable and sufficient risk assessment in place.

This appliance is of A-type and shall not be connected to a flue gas pipe.

It requires a fresh air input of 2m³/h per 1 kW.

SEE "Adjusting charts" § 2.

WARNING:

Materials, assembly and welding tools must be in compliance with the standard EN 45 204.

- **Fixed appliance:**

Connect the appliance to the gas mains using 1/2" NPT pipe and connections. Install a suitable shutoff valve (or valve + pressure regulator) in the supply line, allowing the unit to be isolated from the rest of the cooking range.

- **Mobile appliance:**

Connect the appliance to the gas mains using 1/2" NPT pipe and connections. Install a suitable shutoff valve (or valve + pressure regulator) in the supply line, allowing the unit to be isolated from the rest of the cooking range.

- **Before connecting the appliance, make sure that:**

The gas supply pipe is of the correct size for minimum pressure drop as a function of length, elbows, and total unit capacity.

Ensure that the appliance is set for the type of gas supplied (nature/pressure); see data plate on the appliance and label on the gas connection.

1.6. Power connection

Needed for the oven and options (electric ignition, sequential regulation).

Installation must be undertaken in compliance with the following instructions and with local codes and bylaws. Ensure you have a suitable and sufficient risk assessment in place.

WARNING:

Use a standardized cable (245 IEC 57 or 245 IEC 66) or other approved cable with the same characteristics.

- **Fixed appliance:**

The appliance being constantly connected to a fixed electric source, this source will have to be fitted with a suitable leakage currents protective device.

- **Mobile appliance:**

The appliance being connected to a cable fitted with an electrical plug, the socket should be accessible at all times.



SOLID TOPS / ELECTRIC OVEN



• Before connection :

- Check that the supply voltage is compatible with the voltage of the appliance (see data plate).
- Check that the electric network is equipped with all-pole circuit breakers having a cross section of 3.5 mm, and complies with the European Standard EN 60335-1 dated of May 2003.

The appliance is factory-wired in THREE-PHASE 400V V+E (3~400V+E).

2. CONVERSION TO OTHER TYPES OF GAS

In case there is a different type of gas on site:

2.1. Changing the injectors

See charts below according to the type of burners:

- Choose the correct diameter according to the nature of the gas,
- Get the right air adjustment for the air ring ("d").

Change of gas upon installation:

After having replaced the injectors, ensure of the watertightness of the connection between the injector and its support.

2.1.1. Large solid top plate

Air	Gas type & operating pressure	Mark engraved on the injector	Air adjustment d (mm)*2	Nominal calorific output (kW)*1
1	G20: Pn = 20 mbar	250	10	12
2	G 25: Pn = 20 mbar			
3	G 25: Pn = 25 mbar			
4	G 30: Pn = 29 mbar	180	10	
5	G 30: Pn = 50 mbar			
6	G 31: Pn = 37 mbar			
7	G 31: Pn = 50 mbar			
8	G 110: Pn = 8 mbar			
9	G 120 : Pn = 8 mbar			





SOLID TOPS / ELECTRIC OVEN



2.1.2. Small solid top plate

Air	Gas type & operating pressure	Mark engraved on the injector	Air adjustment d (mm)*2	Nominal calorific output (kW)*1
1	G20: Pn = 20 mbar	190	3	7
2	G 25: Pn = 20 mbar			
3	G 25: Pn = 25 mbar			
4	G 30: Pn = 29 mbar	130	15	
5	G 30: Pn = 50 mbar			
6	G 31: Pn = 37 mbar			
7	G 31: Pn = 50 mbar			
8	G 110: Pn = 8 mbar			
9	G 120 : Pn = 8 mbar			

- 1 Measured power over lower calorific power of the gas (HI) for burner.
- 2 Adjustment of measured primary air according to fig. 2

2.1.3. Pilot lights

Air	Gas type & operating pressure	Mark engraved on the injector	Air adjustment
1	G20: Pn = 20 mbar	40	Open ring
2	G 25: Pn = 20 mbar		
3	G 25: Pn = 25 mbar		
4	G 30: Pn = 29 mbar	20	Open ring
5	G 30: Pn = 50 mbar		
6	G 31: Pn = 37 mbar		
7	G 31: Pn = 50 mbar		
8	G 110: Pn = 8 mbar		
9	G 120 : Pn = 8 mbar		

2.2. Adjusting the air

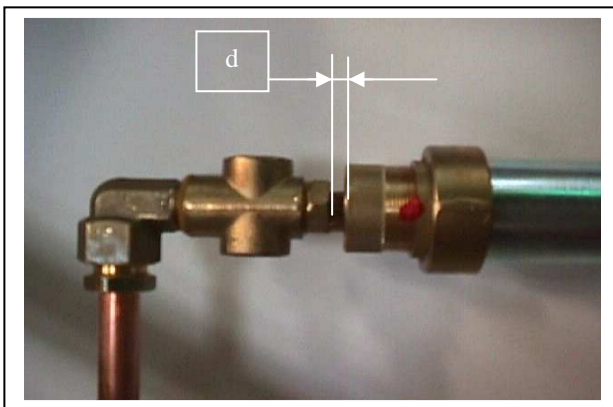

Remove the cast-iron ring plate,
Remove the refractory cement heat retention shielding,

You can reach the air ring and injector

Unlock the air ring (nut/ring),
Change the injector,
(use a 17mm ring spanner)

Adjust distance "d" and lock
(nut/ring), then adjust and seal.



SOLID TOPS / ELECTRIC OVEN



2.3. Checks before connecting electrically the apparatus

Before connecting the apparatus, check that:

- The supply voltage is compatible with the voltage of the apparatus,
- The cable is fixed properly,
- The connections are tight enough,
- The apparatus is well earth wired,
- The section of the cable is of correct size according to the voltage of the apparatus,
- All electric parts are well isolated,

2.3.1. Adjustments

Normally, there is no adjustment to do.

2.3.2. Starting up

Please see the user's manual, section "Starting up"



**Never heat empty pans.
The oven must be free of all objects.
All the above operations are carried out when the appliance is switched off and cold.**

- Connections:

GAS

- Remove the control knobs
(fixed underneath with M 4-mm hexagonal head screws);
- Remove the control panel
(fixed underneath with M 4-mm hexagonal head screws – use a 7-mm hex key);
- Pull the bottom of the panel up and out;
- Connect the appliance to the gas mains using a 1/2" M tube.

Threaded tube M 1/2"





SOLID TOPS / ELECTRIC OVEN



ELECTRICITY

- Unscrew the side control panel to remove it (2 screws).
- Thread connection cable into the chassis, then into the connection box through the rear hole,
- Connect cable to the terminals, and follow the information written on the terminal box.
- Fix the cable along the side of the chassis.

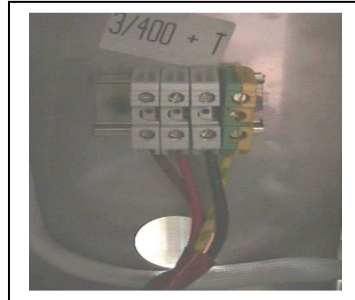

- Before reassembling the parts, check the electrical equipment is properly insulated (cable).



**The appliance must be earth wired.
It is dangerous to connect the appliance unless it is earthed.
We cannot be held responsible for accidents due to non existent or incorrect earth link connection.**

WIRING DIAGRAMS:

Electric appliances	Voltage	Wiring diagrams #
Electric ignition	1 ~ 230 V + E	SE0001 / 00
Oven	3 ~ 400 V + E	SE0011 / 00

3. SERVICING



**Any technical action on an appliance must be undertaken by a qualified technician.
The appliance will have to be isolated from the electrical supply for the duration of the work.
Unplug the appliance.**

When the appliance is ready for use, ensure the users know how to use it properly (See the "User's Manual").

Formerly give the person in charge of the kitchen all documentation needed.

Each appliance has its own data plate.



SOLID TOPS / ELECTRIC OVEN



Transfer all the information written on the data plate to the part of the user's instructions booklet reserved for it.

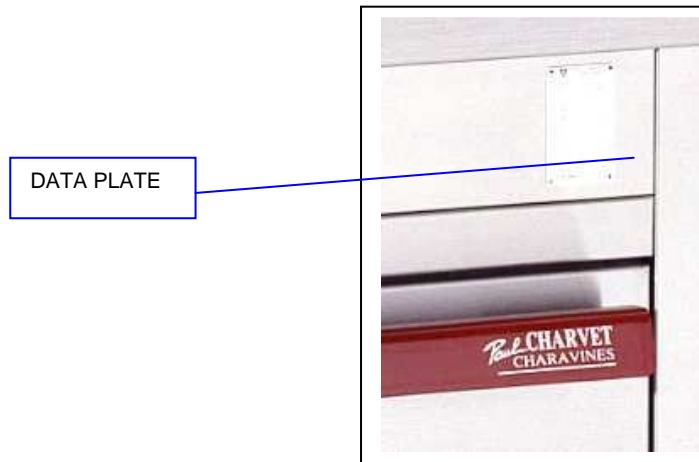

This will ease the communication between you and your client for better service.

WARRANTY: *The warranty is mentioned in our conditions of sale.*



This warranty does not cover damage due to faulty installation, misuse or inadequate maintenance.



SOLID TOPS / ELECTRIC OVEN





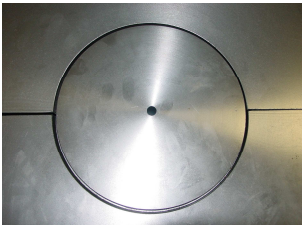
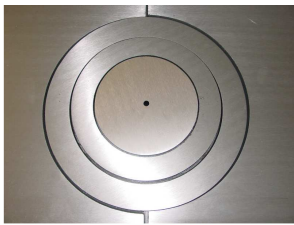

4. BASIC SPARE PARTS LIST

Description	Code	Photograph	Description	Code	Photograph
3-flame pilot light	00177A		Injectors for pilot lights: Natural Propane	01157A 06430A	
Injector (large solid top) φ 1.80 Propane φ 2.50 Natural	00202A 00209A		Injector (small solid top) Φ 1.30 Propane Φ 1.90 Natural	07105A 06985A	
Electrode Solid top plate Oven	03415A		Tap	00311A	
Thermocouple	00291A		Coil Thermocouple valve	00325A	
Connection cable High Voltage electrode / transformer	05317A		Ignition transformer	02161A	
Ring (small solid top plate)	05192A		Ring set (large solid top plate)	05213A	

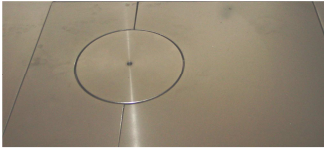
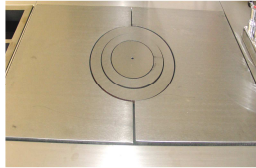
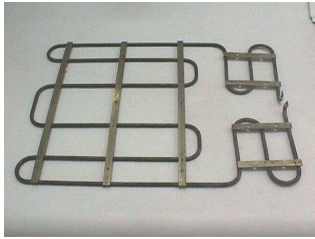

SOLID TOPS / ELECTRIC OVEN



Description	Code	Photograph	Description	Code	Photograph
Solid top plate 600 x 420 mm	05165A		Solid top plate 600 x 845 mm	02926A	
Heating elements 2500 W - 400 V	02063A		Oven switch	00831A	
			Thermostat 300°C	01990A	
			Red indicator 400 V	07136A 07137A	



SOLID TOPS / ELECTRIC OVEN



5. WIRING DIAGRAMS

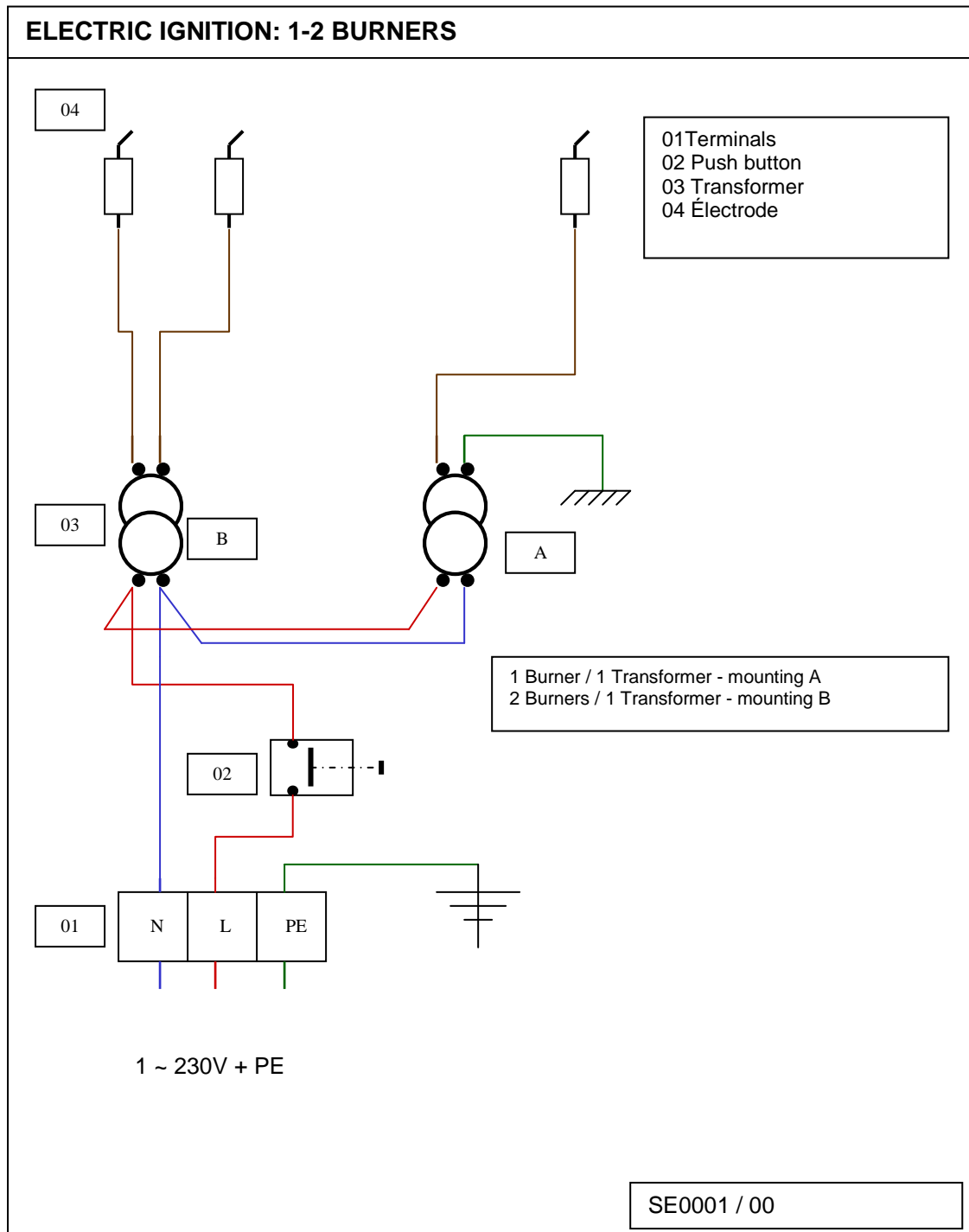



SOLID TOPS / ELECTRIC OVEN

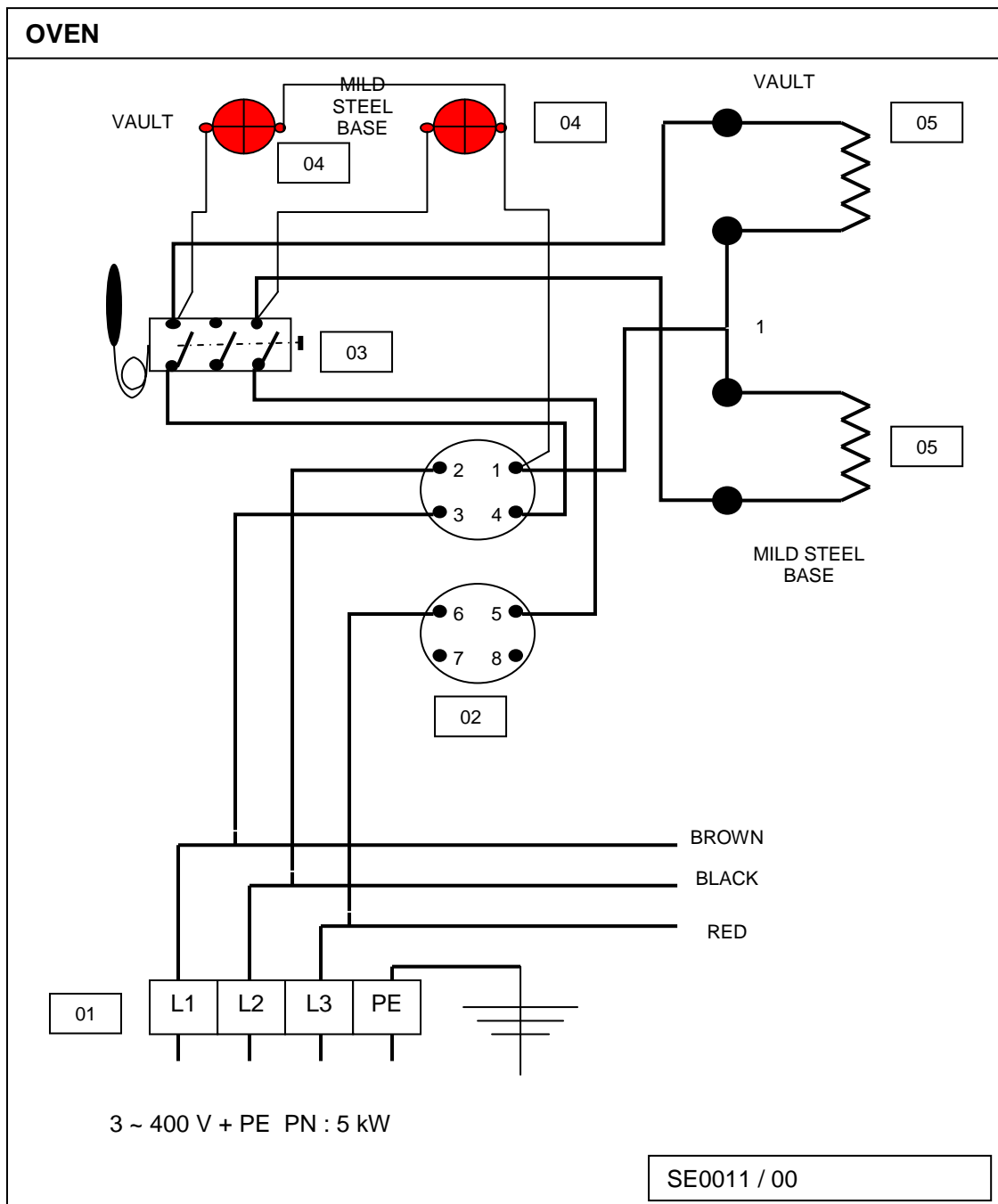

NOMENCLATURE: ELECTRIC OVEN MPL (wiring diagram: SE0011 / 00)

Mark	Code	Description	Quantity
01	02468A	10 mm ² terminal (brand: Viking)	3
01	03575A	16 mm ² Earth terminal (brand: Viking)	1
02	00831A	Oven switch	1
03	01990A	Thermostat 50-300°C	1
04	07136A	Red indicator 400V	2
05	02063A	Heating element 2500 W, 400 V	2





SOLID TOPS / ELECTRIC OVEN



Description	PRO 800	PRO 900
M1PL	V01604	V01536
M2PL	V01584	V01460



USER'S MANUAL





SOLID TOPS / ELECTRIC OVEN



SUMMARY

USER'S MANUAL	1
1. INTRODUCTION	3
2. PRIOR TO STARTING UP	4
3. STARTING UP	4
3.1. Solid top plate	4
3.2. Oven	5
4. SWITCHING OFF	6
5. MAINTENANCE	6
5.1. Cleaning of the stainless steel surfaces	6
5.2. Cleaning the solid top plate	6
5.3. Cleaning the oven	7
6. BREAKDOWN	7
7. DATA PLATE	8





SOLID TOPS / ELECTRIC OVEN



1. INTRODUCTION

- A) Our equipment is for professional use only and must be used by qualified staff.
- B) The equipment must be installed in compliance with local codes and bylaws. It must be installed in a kitchen equipped with an adequately sized mechanical extraction system.
- C) Appliances may be installed side by side or against walls of non combustible material. Distance to combustible material shall be no less than 10 cm.
- D) It is imperative to call for a qualified engineer for all new installations or modifications of existing equipment.
- E) This instruction manual is contractual and must be given to the user after installation.
- F) **WARRANTY:** The warranty is mentioned in our conditions of sale. Only a qualified engineer certifies the validity of the warranty. This warranty does not cover damage due to faulty installation, misuse or inadequate maintenance.

Dimensions:

Length: 850 mm
Depth: 900 mm
Height: 900 mm

Specifications:

One-piece seam welded 18-10 stainless steel chassis, 1 to 3 mm thick.
18-10 stainless steel top frame, 3 mm thick, with a 55 mm high edge having a 18 mm radius and return to underside.
18-10 stainless steel flue.
18-10 stainless steel side panels, 1 mm thick; assembly with no visible screws.
Enameled steel control panel with control symbol markings.
Recessed gas and electric controls with micro-sandblasted aluminium surface.
Oven folded handle in enameled steel fitted on micro-sandblasted aluminium supports.
18-10 stainless steel legs, 200 mm high, with adjustable PVC feet, diameter 60.3 mm, adjustment +10/-20 mm.

Top:

M1PL:

One two-piece cooking plate (845 x 600 mm) with a centered set of rings.
"Crown-burner" rated 12 kW on refractory cement heat retention shielding - stainless steel support.
Pilot light and safety thermocouple integrated to the burner.
18-10 stainless steel drip tray in front.

M2PL:

Two two-piece cooking plates (600 x 420 mm) with a centered ring.
"Crown-burners" rated 7 kW on refractory cement heat retention shielding - stainless steel support.
Pilot lights and safety thermocouples integrated to the burners.
18-10 stainless steel drip trays in front.





SOLID TOPS / ELECTRIC OVEN



Electric oven GN2/1:

Dimensions:

Length: 530 mm

Depth: 650 mm

Height: 300 mm

Mild steel base and vault: Heating elements rated 5 kW in total - 3 ~ 400V+ E.

8-position switch: 'vault - 0 - Mild steel base - 0 - Low V+MSB - 0 - High V+MSB - 0 -' & regulation thermostat 50-300°C + indicators

Steel mild steel base, 4 mm thick

Insulated stainless steel muffle with stainless steel protection.

Removable 3-position enamelled steel shelf runners with a 70-mm space.

18-10 stainless steel door and indoor with rock wool insulation - handle in enamelled steel on aluminium support.

Options:

Electric ignition of the burners.

2. PRIOR TO STARTING UP

- Prior to starting up, it is advisable to clean the appliance in order to eliminate all dust and impurities that have accumulated during storage.
- Remove all plastic protection that wraps the stainless steel panels.
- Make sure that all controls are in good working condition before turning the gas on.

3. STARTING UP

Overview: Each burner is equipped with a safety thermocouple and a pilot light.

3.1. Solid top plate

- Take off the central ring.
- Push and turn the control knob counter-clockwise of desired burner (fig. 1, mark "P") until the spark symbol.
- Keep pushing thoroughly while presenting a flame or pressing the ignition push button (if fitted).
- Keep the control knob pressed for 5 to 15 sec. before releasing it,
- The pilot light must remain ignited, Repeat the operation if it fails,
- When the pilot light is on, turn the control knob counter-clockwise to the desired position (large flame symbol); the burner is running at full power,
- By turning the control knob to the next position (small flame symbol), the burner is on the slow-down position (simmering position).
- When done, refit the central ring.

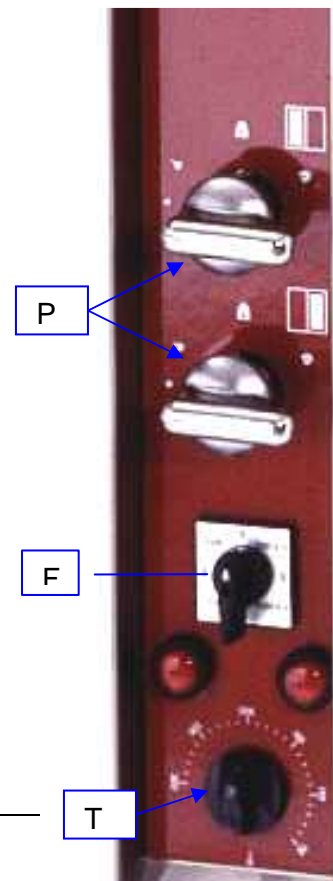

Figure 1



SOLID TOPS / ELECTRIC OVEN



3.2. Oven

- Turn control knob to the desired heating position (VAULT, VAULT + MILD STEEL BASE, MILD STEEL BASE): the ON indicator is alight.
- Choose the desired temperature (according to the foods to cook) with the thermostat: the regulation indicator is alight.
- When the desired temperature is reached, the regulation indicator goes off.
- The regulation thermostat will constantly adjust the temperature of the oven.
- Cooking temperatures will be reached after 15 mn about of heating process.

TEMPERATURES, RECOMMENDED PREHEATING TIMES, TYPES OF COOKING*

THERMOSTAT SETTINGS	PREHEATING TIMES	PRODUCTS
80°C - 100°C	20''	Holding temperature
120°C - 140°C	30'' - 40''	Pastry
150°C - 170°C	1' - 1'30	FISH
190°C - 220°C	2' - 3'	WHITE MEATS
240°C - 260°C	4' - 6'	Gratins
270°C - 310°C	7' - 9'	RED MEATS

**These figures are only indicative.*

PRACTICAL ADVICE:

You can cook various types of foods with the oven: foods on baking plates (grilling foods, pastries), in pans (braising) by the use of the position HIGH VAULT/MILD STEEL BASE; VAULT position only for the browning and icing operations.

Level the oven grid depending on the type of foods to be cooked.

The faster the oven heats, the faster cooking temperatures are reached. During non-cooking periods, we advise you to turn the switch to the LOW VAULT / MILD STEEL BASE position (energy-saver mode).

This lowest position is ideal for cooking smooth baked foods (like pastries).

Select the aperture of the air-inlet (located above the oven door) to evacuate cooking steams.

OPEN

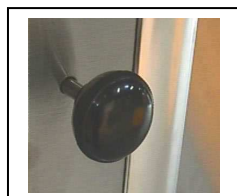

CLOSED

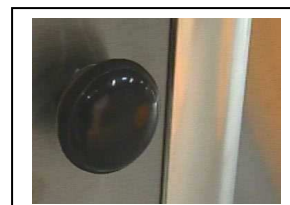



SOLID TOPS / ELECTRIC OVEN



WARNING:

Be careful of steam escaping when opening the oven door after “wet” cooking process. Serious risks of burns!

Side panels and oven door may be extremely hot after a prolonged or intensive use. Be careful to open the door only with the handle, and stay clear from the door.

4. SWITCHING OFF

- a) Turn control knobs to "●" and oven thermostat to the "STOP" position.
- b) Before doing anything on the appliance, wait until cooking areas has cooled down.
- c) Clean the oven, the oven shelf, the grease collection drawer, and the drip tray after each use - in order to remove food particles and liquids.
- d) At the end of the day, cut off gas supply or/and switch off electricity at the mains (or disconnect from the wall socket).

5. MAINTENANCE

5.1. Cleaning of the stainless steel surfaces

- a) Switch off the appliance,
- b) Wait until the apparatus has cooled down before doing anything on it,
- c) Wash with a sponge in soapy water (or any other neutral cleaning product). *Do not use bleach or any other acidic product – even well diluted.*
- d) For the tops, use a nylon scouring pad if necessary. Always go with the grain.
- e) After each cleaning, rub with a greased cloth or kitchen paper.
- f) Finger marks can be removed with a cloth dabbed with alcohol.

5.2. Cleaning the solid top plate

- a) Clean with an appropriate scouring pad. Grease the cast-iron plate(s) if you don't use the appliance.
- b) Remove the solid top plate(s) to clean the refractory cement heat retention shielding.
- c) The drip tray should be cleaned daily.
- d) Refit in order all the parts.



**Clean the solid top with a Tampico brush or a wood spatula.
Never clean the cast iron solid top with ice.
Dry the cast iron solid top carefully to avoid rusting. Then clean with a greasy cloth.**



SOLID TOPS / ELECTRIC OVEN



5.3. Cleaning the oven

- a) Switch off the oven.
- b) Wait until the apparatus has cooled down before doing anything on it,
- c) To avoid fumes due to greases, stains and food particles, we recommend you to clean all the oven internal sides every day, Wash with a sponge in soapy water (or any other neutral cleaning product),
- d) Remove all accessories (roasting grid, etc.) from the oven as well as the sides and the mild steel base in order to clean them,
- e) Also clean the heating element housing to remove all charred residues,
- f) Grease the mild steel base with cooking oil after cleaning.
- g) Refit in order all the parts.



**Our equipment must not be cleaned with water under pressure or be subjected to a deluge of water splashes (the burner can be damaged).
Check that the appliance is well disconnected at the mains.**

For best results, have your equipment serviced and cleaned on a regular basis by a qualified installer.

WARNING: Certain parts of this appliance are protected by the manufacturer, and must not be handled by the installer or the user.

6. BREAKDOWN

UNSATISFACTORY HEATING: Probable causes

- Clogging of the burners, injectors, etc.
- Incorrect gas pressure.
- Incorrect grading of the injectors.
- Clogging of the rear internal flue box (solid top plate(s), oven).

THE INDICATORS ARE ALIGHT BUT THE OVEN DOESN'T HEAT

- Faulty heating element(s).

ONE INDICATOR IS UNLIT

- The oven is heating: Faulty indicator bulb.
- The oven is not heating: Faulty thermostat or switch.

FAULTY IGNITION

- Clogging of the pilot lights,
- Clogging of the thermocouples.
- Smashed thermocouple, incorrect pilot light output and positioning, and insufficient pressure on control button.
- Faulty electric ignition (option).





SOLID TOPS / ELECTRIC OVEN



Call for your installer to replace the faulty electric components in preparation for a next use.



Only a qualified electrician should replace the ignition transformers.

The manufacturer and the installer cannot be held responsible if the user neglects to ask for assistance in case of breakdown.

7. DATA PLATE

TRANSFER below the information written on the DATA PLATE of your apparatus.

This will help you with maintenance problems and spare parts.

		CHARVET S.A.			
		38850 CHARAVINES			
Réf.	<input type="text"/>				
Code:	<input type="text"/>	Type:	<input type="text"/>		
N°FC:	<input type="text"/>		<input type="text"/>		
N°OF:	<input type="text"/>	Rep.	<input type="text"/>		
Cat.					
Gaz					
P (mbar)					
ΣQ_n (kW)					
ΣV_n (m ³ /h)					
ΣM_n (kg/h)					
U	<input type="text"/>	V	<input type="text"/>	Hz Ip	<input type="text"/>
P	<input type="text"/>	kW	<input type="text"/>		
		<input type="text"/>			
MADE IN FRANCE					

