

Installation and Set Up Instructions For Gas Cooking Ranges

Description	PRO 800 Series	PRO900 Series
G3FN/PL	V01587	V01463
G3PL/FN	V01591	V01467
B-G3FN/PL	V01589	V01466
B-G3PL/FN	V01593	V01470
R-G3FN/PL	V01590	V01727
R-G3PL/FN	V01594	V01728



2 OPEN BURNERS + 1 SOLID TOP ON GAS OVEN
(not contractual photograph)





SUMMARY

1. INSTALLATION	2
1.1. GENERAL POINTS	2
1.2. HANDLING.....	2
1.3. INSTALLATION	2
1.4. DATA PLATE.....	3
1.5. FIXING THE FLUE	3
2. CONNECTING THE APPLIANCE TO THE GAS MAIN.....	4
2.1. CHECKS BEFORE CONNECTION.....	4
2.2. CONNECTING THE APPLIANCE	5
2.3. CHECKS AFTER CONNECTION.....	6
3. CONVERSION TO OTHER TYPES OF GAS	6
3.1. REPLACING OPEN BURNER AND SOLID TOP NOZZLES AND ADJUSTING THE AIR RING	6
3.2. REPLACING OVEN BURNER NOZZLES AND ADJUSTING THE OVEN PILOT LIGHT.....	7
3.3. GAS ADJUSTMENT CHARTS	8
3.4. SLOW DOWN ADJUSTMENT PROCEDURE	9
4. POWER CONNECTIONS.....	11
4.1. CHECKS BEFORE CONNECTION.....	11
4.2. CONNECTION	12
4.3. CHECK AFTER CONNECTION	14
5. ADJUSTING THE APPARATUS TO DIFFERENT NETWORK VOLTAGES	14
5.1. DIFFERENT NETWORK VOLTAGES	14
5.2. WIRING DIAGRAMS	14
6. WATER CONNECTION	19
6.1. CONTROLS AND CHECKS	19
7. BASIC SPARE PARTS LIST.....	20



1. INSTALLATION

1.1. General points

Installation must be undertaken in compliance with the following instructions and with local codes and bylaws. Ensure you have a suitable and sufficient risk assessment in place.

The user manual must be given to the user after installation.

1.2. Handling

It is imperative to leave the appliance on its wooden pallet for handling on site until the final installation.

Unpack and check the apparatus for damage upon receipt.

In case of damage, mark delivery note accordingly and immediately (within 48 hours) notify the carrier by registered mail with acknowledgement of receipt. Notify your installer.

1.3. Installation

This appliance must be installed under a suitable mechanical extraction hood, close to the gas supply.

If the apparatus is to be installed against a wall or partition, near a piece of furniture or decorative borders, it is recommended that these are made of fireproof material.

If this is not the case, they must be protected by an approved fireproof, insulating material.

All local fire regulations must be adhered to.

If in doubt fireproof construction of adjacent walls, distance to combustible material shall be no less than 10 cm.

Remove all plastic protection.

NOTICE



- **Fixed appliance:**

Install the feet or the levelling studs (they are delivered in a box kept inside the appliance). Adjust height to level the unit to an horizontal working plan of 900 mm. Fix all independent half module against the wall.

- **Mobile appliance :**

Install the castors (they are delivered in a box kept inside the appliance). The castors with brakes must be locked when the appliance is being connected and during cooking times. Fix all independent half module against the wall.

Any technical action on an apparatus must be undertaken by a qualified technician. The apparatus will have to be isolated from the electrical or gas supply for the duration of the work.



When the apparatus is ready for use ensure the users know how to use it properly (see users guide). Formerly give the person in charge all documentation needed.

WARRANTY: The warranty is specified on the conditions of sale and does not cover damage due to incorrect installation, misuse or inadequate maintenance.

Installation and Set Up Instructions For Gas Cooking Ranges

1.4. Data plate

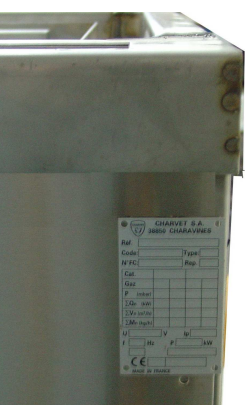
Each apparatus has its own data plate. Transfer all the information on the data plate to the part of the user instructions booklet reserved for it (see the last page). The data plate will ease the communication between you and your client for better service. See locations below:

		
<p>Appliances with open base</p>	<p>Bridge units</p>	<p>Appliances with gas oven</p>

1.5. Fixing the flue

Install the flue on top of the appliance and ensure the flue is free of obstruction. To fix a short flue (300 mm > 377 mm high max.), see below:

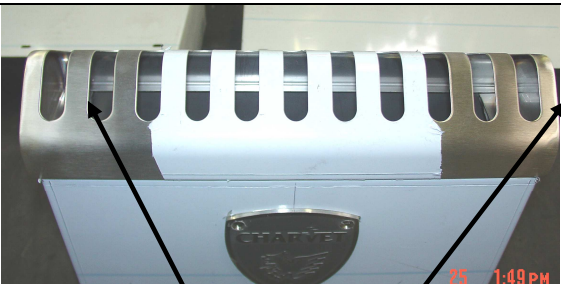
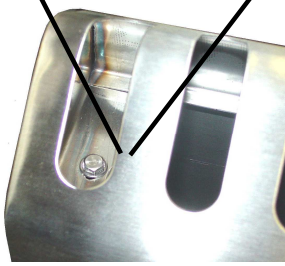
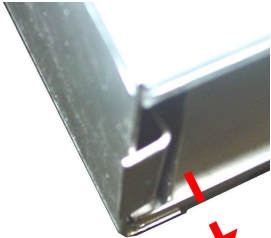
<p>Unscrew the two fixing screws located at the right and left hand sides (see Fig.1 & 2) to release the fixing fasteners (see Fig. 3).</p>	<p>Fig. 1</p> 
	<p>Fig. 2</p> 
<p>Install the flue above the space reserved for it and slide the fixing fasteners underneath the top of the appliance. Screw the two screws to fix the flue (see Fig. 1 & 2).</p>	<p>Fig. 3</p> 

2. CONNECTING THE APPLIANCE TO THE GAS MAIN

Material, assembly and welding tools must be in compliance with the standard EN 45 204.

NOTICE



- **Fixed appliance:**
Connect the burner strip to the gas mains using 1/2" NPT pipe and connections. Install a shutoff valve in the supply line allowing the unit to be isolated from the rest of the system.
- **Mobile appliance:**
Connect a 1/2" approved armoured flexible gas hose equipped with a quick disconnect fitting including automatic gas shut off to the gas connection located on the rear of the appliance. Remember to use the security chain.

2.1. Checks before connection

Ensure that:

- The supply pressure and the supply gas should match that shown on the data plate for the gas used.
- The gas supply pipe is of the correct size for minimum pressure drop as a function of length, elbows and total unit capacity.
- The gas main is free of obstruction.
- The air adjustment output is of 2 m³/h/kW. See chart A below:

CHART A			
Code of the appliance	Description of the appliance	Gas power (kW)	Air adjustment output required (m ³ /h/kW)
V01587 V01463	G3FN/PL	34.5	69
V01591 V01467	G3PL/FN	34.5	69
V01589 V01466	B-G3FN/PL	23.5	47
V01593 V01470	B-G3PL/FN	23.5	47
V01590 V01727	R-G3FN/PL	23.5	47
V01594 V01728	R-G3PL/FN	23.5	47

2.2. Connecting the appliance

Fig. 1

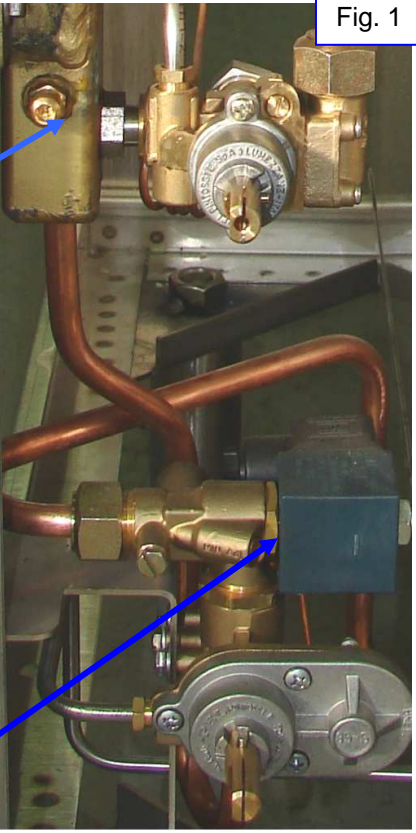

Gas connection

Pressure outlet

To reach the pressure outlet:
 - Remove the control knobs
 - Remove the control panel (screwed on the lower part)

Thermostatic valve

- **Units with a gas oven base:**
 To reach the gas connection:
 - Remove the side panel (fixed with 4 screws).
 - Connect to tube M 1/2".

Fig.2



Gas connection

Pressure outlet

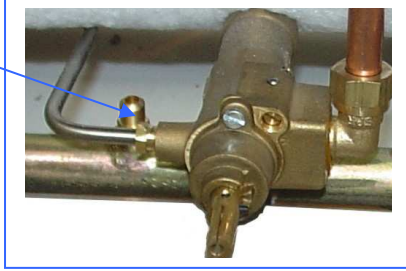

- **Units with an open base:**
 - Remove the control knobs.
 - Remove the control panel.
 - Connect to tube M 1/2".

2.3. Checks after connection

Ensure of:

- The watertightness of the gas pipe and connection.
- The supply pressure of the appliance. To take the pressure, do as follow:
 - Remove the control knobs,
 - Remove the control panel,
 - Connect the pressure outlet on the pressure outlet located on the ramp (see figures 1 & 2),
 - Put the appliance in working conditions (or all the appliances if they are connected to the same gas supply), maximum output,
 - Then check your figures with charts B-C-D-E (see § 3.3.).
- The colour of the flame (blue),
- The slow down position (see § 3.4.),
- The good working conditions of the appliance and of its safety controls.

3. CONVERSION TO OTHER TYPES OF GAS

In case there is a different type of gas from the one used normally. When done, ensure of the watertightness of the connection between the injector and its support.

3.1. Replacing open burner and solid top nozzles and adjusting the air ring

See charts below:

- To choose the correct diameter depending on the nature of the gas,
- To get the right air adjustment for the air ring on the burner.

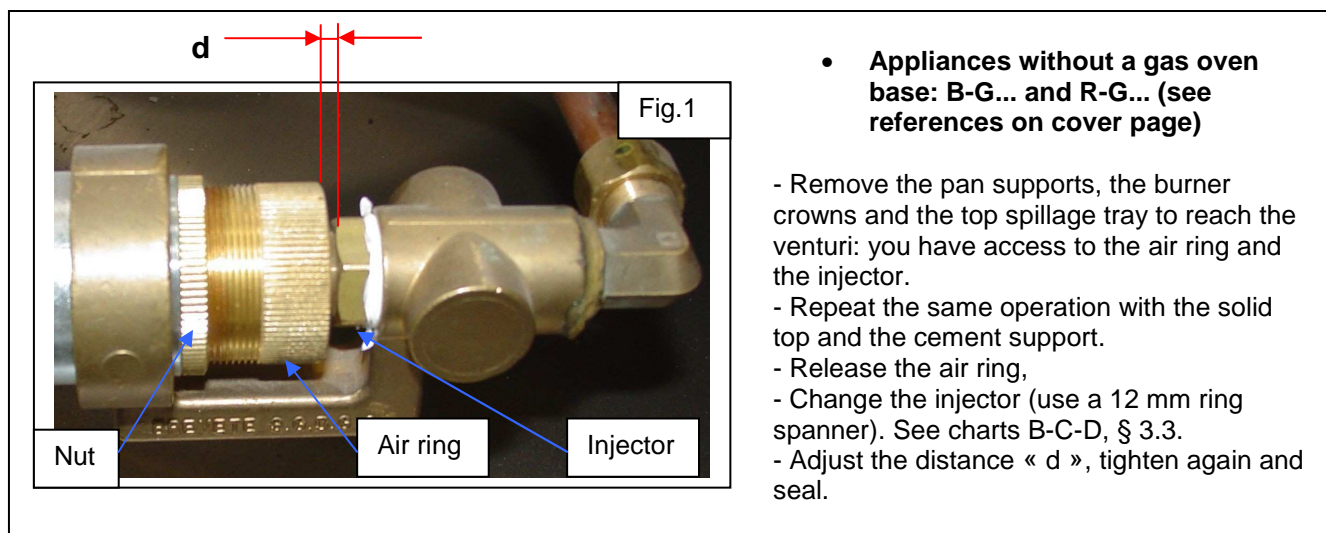

Fig.2

- **Appliances with a gas oven base: G3... (see references on cover page)**
- Remove the mild steel base to reach the air ring and injector,
- Release the air ring and move it back to reach the injector,
- Change the injector (use a 17 mm ring spanner). See chart E, § 3.3.
- Adjust the distance « d », tighten again and seal.

3.2. Replacing oven burner nozzles and adjusting the oven pilot light

a

a

Procedure

- Remove the mild steel base,
- Unscrew the pilot light support,.
- Unscrew the pilot light gas connection,
- Unscrew the nut Y with a '12' open-ended spanner (Fig. a1 and a2),
- Change the injector (see chart E),
- To adjust the air ring, see Fig.a3 and chart E §, 3.3.

! Warning When done, ensure of the waterproofness of the connection between the injector and its support and of the good working state of the pilot light.



Installation and Set Up Instructions For Gas Cooking Ranges

3.3. Gas adjustment charts

Open burner Ø 110 mm			CHART B	
Adjustment	Gas type & operating pressure	Mark engraved on the injector	Air adjustment d (mm) ²	Calorific output in kW ¹
1	G20 : Pn = 20 mbar	230	3	10
2	G 25 : Pn = 20 mbar			
3	G 25 : Pn = 25 mbar			
4	G 30 : Pn = 29 mbar	135	Max	
5	G 30 : Pn = 50 mbar			
6	G 31 : Pn = 37 mbar			
7	G 31 : Pn = 50 mbar			

- ¹ Measured power over lower calorific power of the gas (HI) for one open burner
- ² Regulation of air according to diagram 1

Open burner Ø 80 mm			CHART C	
Adjustment	Gas type & operating pressure	Mark engraved on the injector	Air adjustment d (mm) ²	Calorific output in kW ¹
1	G20 : Pn = 20 mbar	190	4	6.5
2	G 25 : Pn = 20 mbar			
3	G 25 : Pn = 25 mbar			
4	G 30 : Pn = 29 mbar	110	Max	
5	G 30 : Pn = 50 mbar			
6	G 31 : Pn = 37 mbar			
7	G 31 : Pn = 50 mbar			

Solid top 420x600 mm			CHART D	
Adjustment	Gas type & operating pressure	Mark engraved on the injector	Air adjustment d (mm) ²	Calorific output in kW ¹
1	G20 : Pn = 20 mbar	190	3	7
2	G 25 : Pn = 20 mbar			
3	G 25 : Pn = 25 mbar			
4	G 30 : Pn = 29 mbar	130	15	
5	G 30 : Pn = 50 mbar			
6	G 31 : Pn = 37 mbar			
7	G 31 : Pn = 50 mbar			

- ¹ Measured power over lower calorific power of the gas (HI) for one open burner
- ² Regulation of air according to diagram 1

Oven burner 650x530x300 mm				CHART E	Pilot light	Oven
Adjustment	Gas type & operating pressure	Mark engraved on the injector	Air adjustment d (mm) ²	Calorific output in kW ¹	Mark engraved on the injector	Air adjustment d (mm) ²
1	G20 : Pn = 20 mbar	250	2	11	40	None
2	G 25 : Pn = 20 mbar					
3	G 25 : Pn = 25 mbar					
4	G 30 : Pn = 29 mbar	165	4		20	None
5	G 30 : Pn = 50 mbar					
6	G 31 : Pn = 37 mbar					
7	G 31 : Pn = 50 mbar					

3.4. Slow down adjustment procedure





Never screw or unscrew the slow down screw. This could lead to serious problems such as the suppression of the slow down function. Only a qualified technician is authorized to carry out this adjustment.

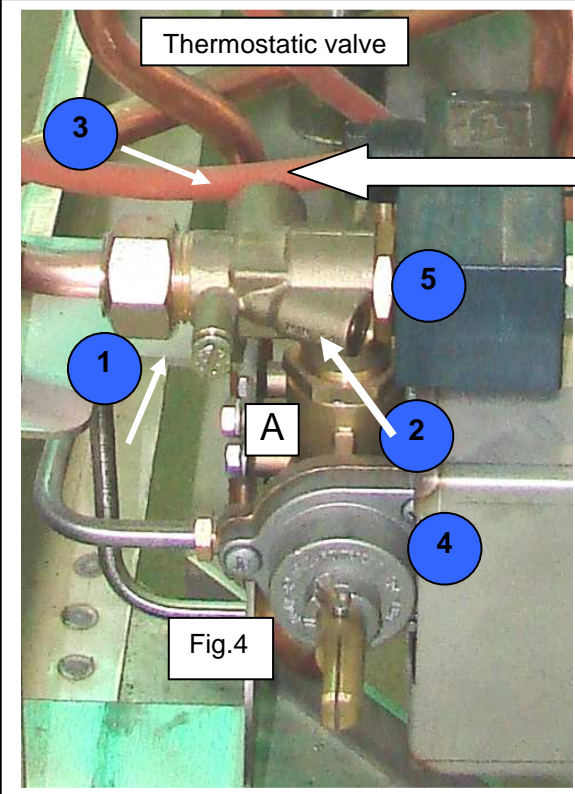



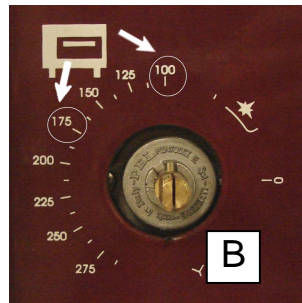

This operation must be carried out very quickly and before the thermostat responds and the burner turns to the maximum output position.

Note: The maximum output position reduces the flames to ¼ of their size. The burner must remain alight when proceeding from the maximum output position to the minimum output position.

- 1) Pressure outlet
- 2) Minimum output screw
- 3) Maximum output screw
- 4) Thermostat
- 5) Thermostatic valve

Slow down adjustment procedure of the oven burner:

- Remove the control knobs.
- Remove the control panel.
- Set the control knob back (A).
- Preheat the oven for 15 minutes: ignite the burner and close the oven door (Thermostatic valve at 175°C, then turn it to the 100°C position. Fig. B).
- Screw (3) to reduce the output and unscrew to increase it.
- Screw (2) to reduce the output and unscrew to increase it.
- You can take the pressure from the pressure outlet (1).

Slow down position of the control knob

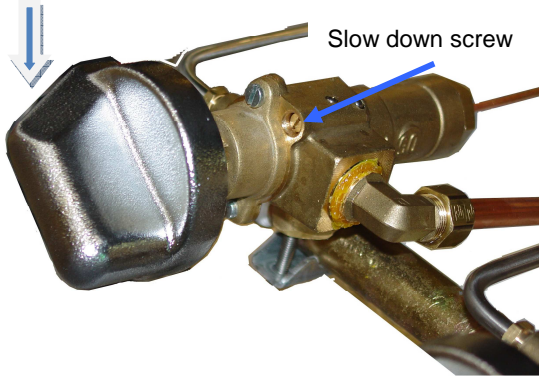

= Small flame or slow down position

• **Slow down adjustment procedure of the open burner**

- Remove the control knobs.
- Remove the control panel.
- Set the control knob back
- Turn on the apparatus (see User Operation and Maintenance Instructions, § 2.)
- Turn to the left the control knob
- Adjust the slow down position with the slow down screw:
 - > unscrew it to increase the slow down position
 - > screw it to reduce the slow down position

Nota: The burner must remain alight during this procedure.

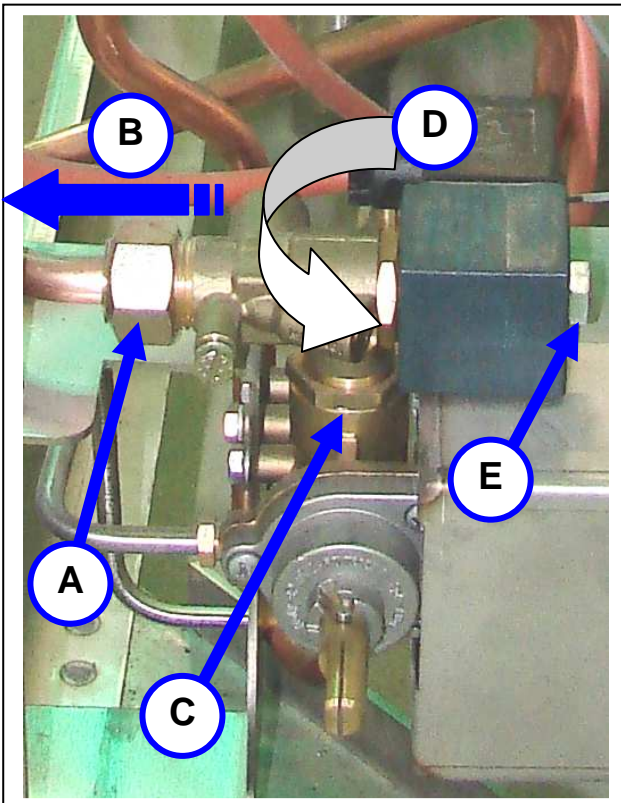

• **Changing the solenoid valve**

- Unscrew the nut (A).
- Then pull the copper pipe to the left (B).
- Unscrew the nut (C).
- Then rotate the solenoid valve (D) and unscrew the nut (E) to remove the solenoid valve.



4. POWER CONNECTIONS

Electric ignition and water filling of removable water tank are considered as options.

NOTICE



**The apparatus must be earth wired.
It is dangerous to connect the apparatus unless it is earthed.**

Use a standardized cable (245 IEC 57 or 245 IEC 66) or other approved cable with the same characteristics.

Check that the electrical voltage of the supply is compatible with the voltage of the apparatus (see data plate).

. Fixed appliance

The apparatus being connected to a cable fitted with an electrical plug, the socket should be equipped with an omnipolar circuit breaker with a cross section of 3.5 mm at least. All electrical equipment must be in compliance with the European norm EN 60335.

. Mobile appliance

The apparatus being connected to a cable fitted with an electrical plug, the socket should be accessible at all times.

We cannot be held responsible for accidents due to non existent or incorrect earth link connection.

4.1. Checks before connection



All this operations are carried out when the apparatus is switched off and cold.

Before connection, ensure that:

- The supply voltage is compatible with the voltage of the apparatus,
- The cable is fixed properly,
- The connections are tight enough,
- The section of the cable is suitable for the power,
- The electrical equipment is properly insulated.

Installation and Set Up Instructions For Gas Cooking Ranges

4.2. Connection

The apparatus is delivered with a high temperature flexible cable which is either located inside the open base or behind the left side panel in case of the presence of an oven.

Connect the apparatus to the electrical network.

4.2.1. Appliance with electric ignition

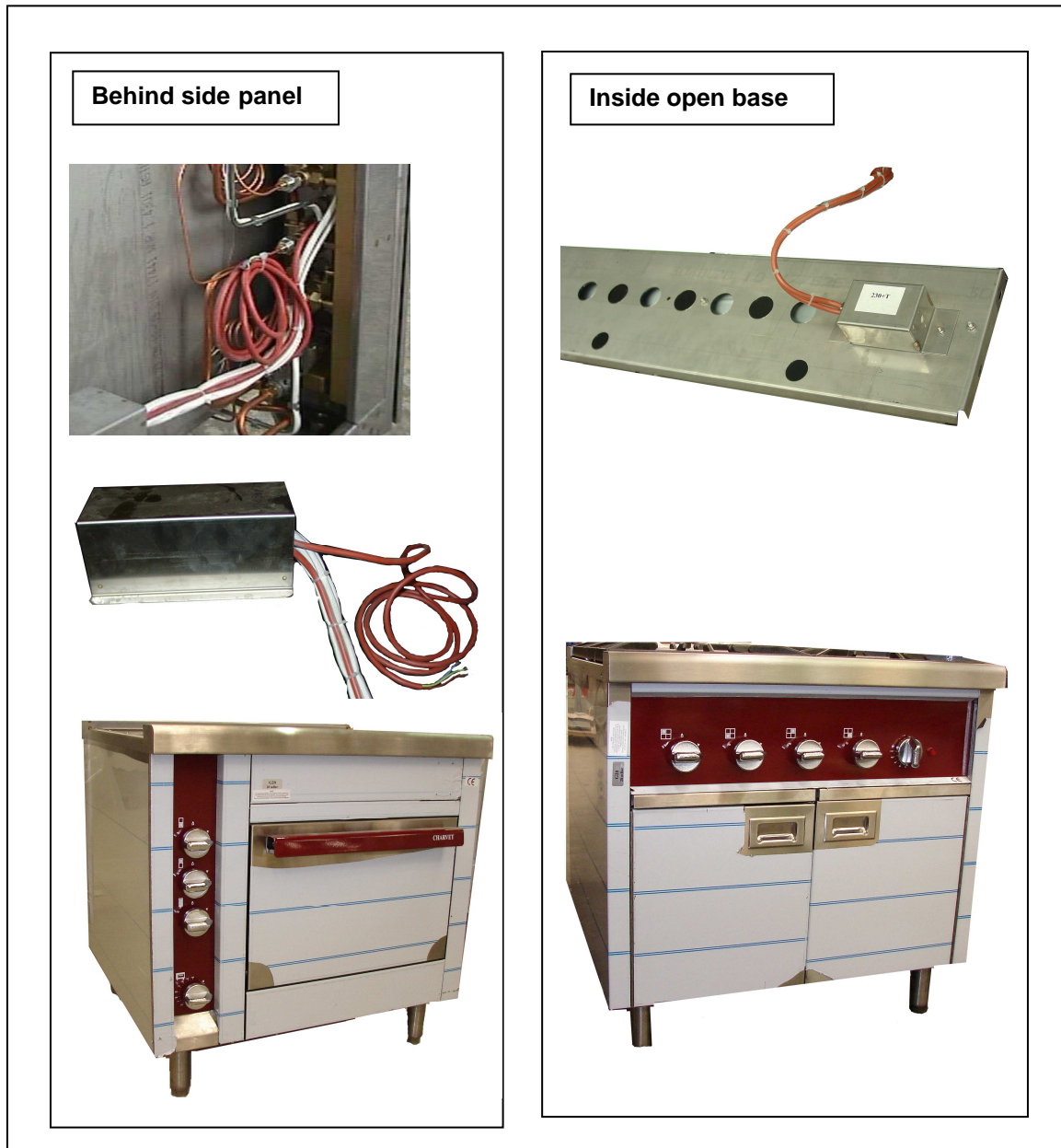

4.2.2. Appliance with water filling of removable water tank for burner

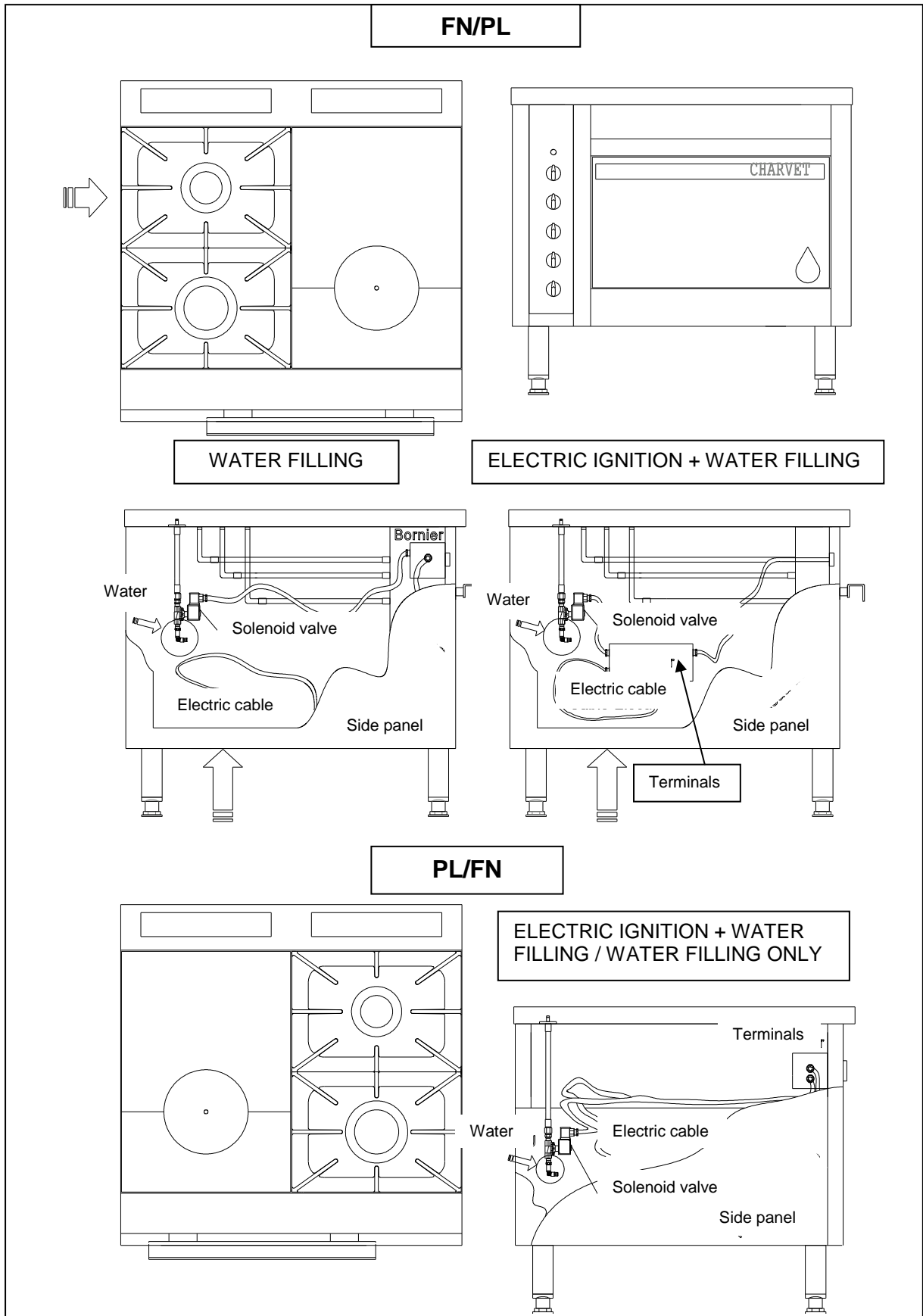



Installation and Set Up Instructions For Gas Cooking Ranges

4.3. Check after connection

After connection, ensure that:

- The appliance is earth wired,
- The electrical equipment is properly insulated,
- The appliance is in good working conditions: electric ignition, thermostat... (see User Operation and Maintenance Instructions).

5. ADJUSTING THE APPARATUS TO DIFFERENT NETWORK VOLTAGES

5.1. Different network voltages

Transformation voltages	1~230V+E	3~230V+E	3~400V+E	3~400V+N+E
Voltages of the options				
Electric ignition		A	C	A
1~230V+E				
Water tanks		A	C	A
1~230V+E				
Electric ignition + Water tanks		A	C	A
1~230V+E				

A → Coupling possible B → Please consult C → Coupling not possible D → Voltage unavailable

5.2. Wiring diagrams

Apparatus	With oven	With open base
Electric ignition	1	1
Voltage	1~230V+ E	1~230V+ E
Electrical wiring diagram	SE001/00	SE001/00
Water tanks	1	1
Voltage	3	3
Electrical wiring diagram	SE0099/00	SE0099/00
Electric ignition + Water tanks	1	1
Voltage	3	3
Electrical wiring diagram	SE0101/00	SE0101/00

1 → Possible option 2 → Option not available 3 → Please consult the factory

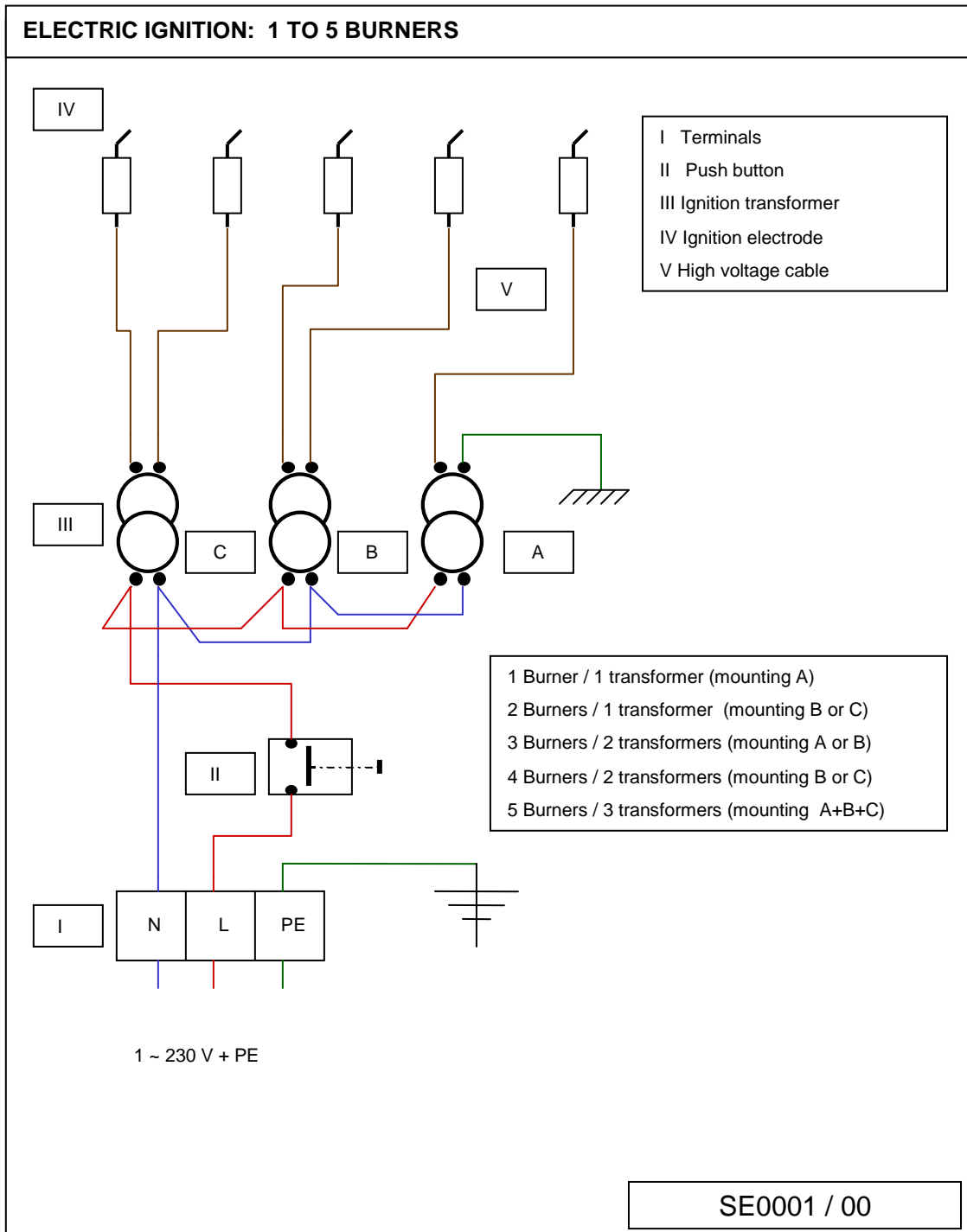

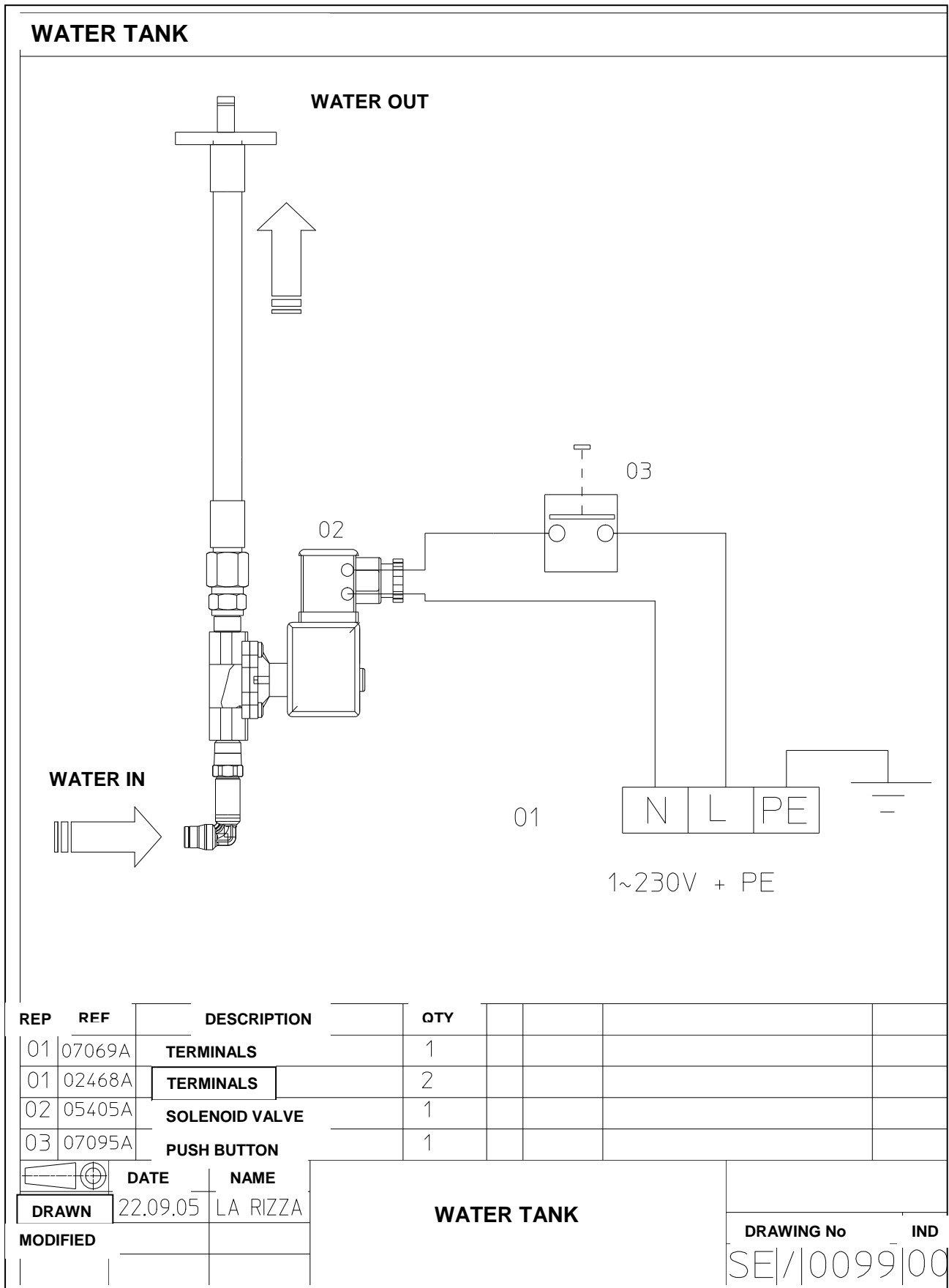

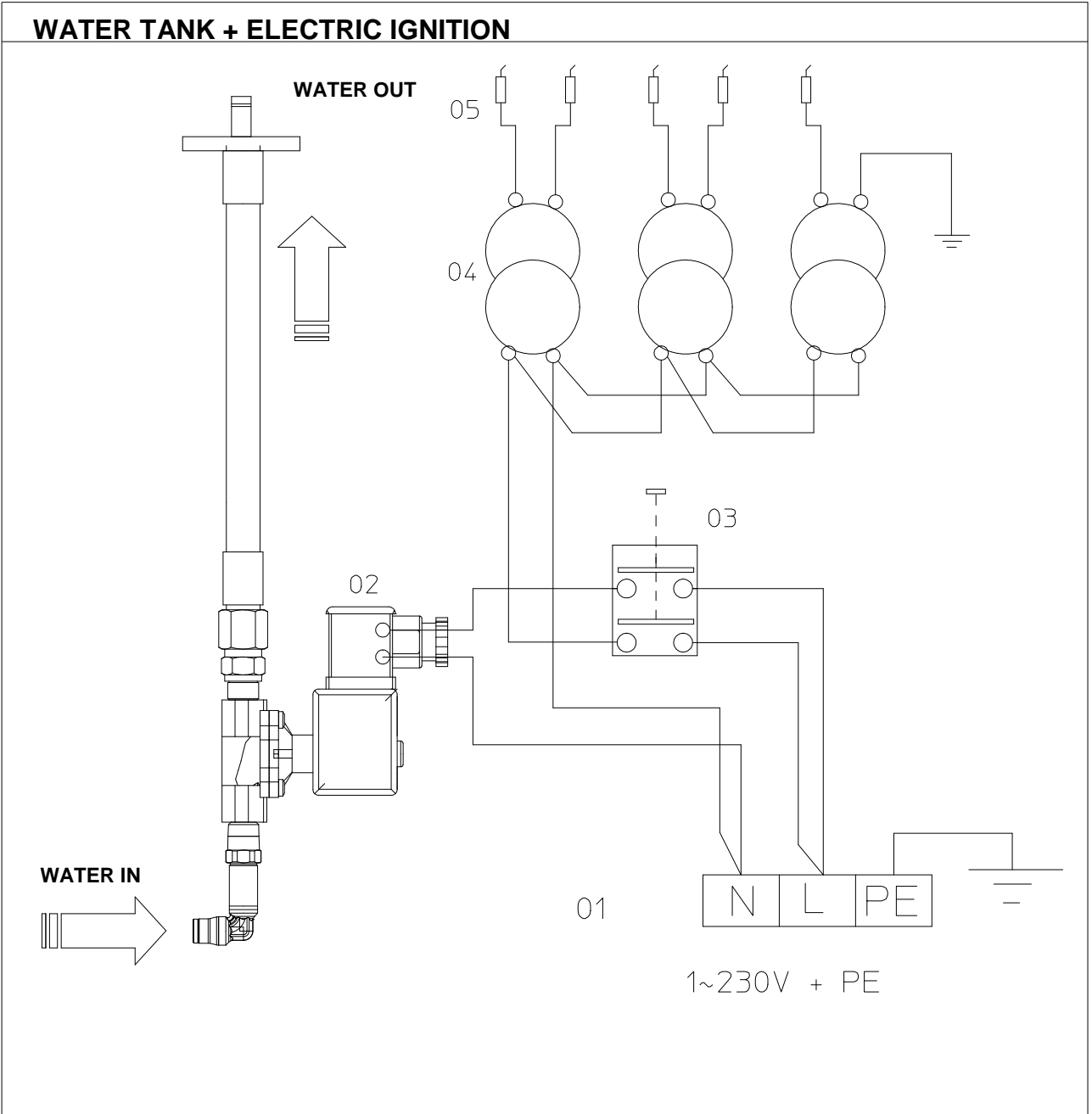

REP	REF.	DESCRIPTION	QTY	REP	REF.	DESCRIPTION	QTY
01	07069A	TERMINALS	1	04	02161A	IGNITION TRANSFORMER	3
01	02468A	TERMINALS	2	05	07010A	IGNITION ELECTRODE	5
02	05405A	SOLENOID VALVE	1				
03	02105A	PUSH BUTTON	1				

	DATE	NAME	WATER TANK + ELECTRIC IGNITION DRAWING	PLAN No		IND
DRAWN	19.10.05	LA RIZZA		SE /	0101	00
MODIFIED						

Ce plan est notre propriété. Il ne peut être copié, ni communiqué sans notre autorisation

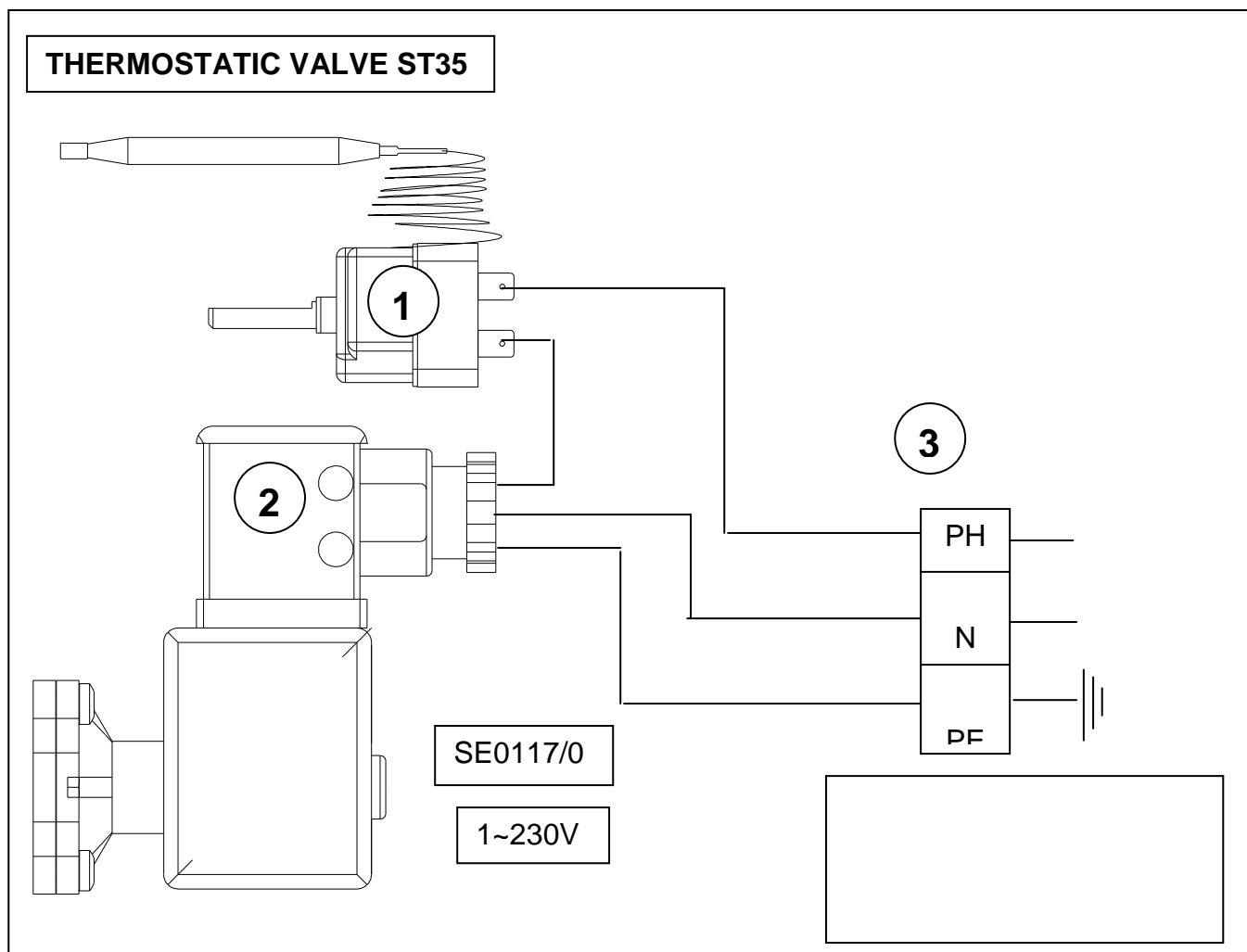

NOMENCLATURE: THERMOSTATIC VALVE (SE0117/0)

Mark	Ref.	Description	Quantity
01	08426A	Thermostat	1
02	08425A	Solenoid valve	1
03		Terminal	1

6. WATER CONNECTION

Connection point: the 6/8 elbowed connection of the solenoid valve.

6.1. Controls and checks

After connection, make sure that:

- The circuit is water tight,
- The water circuit is in good working conditions.

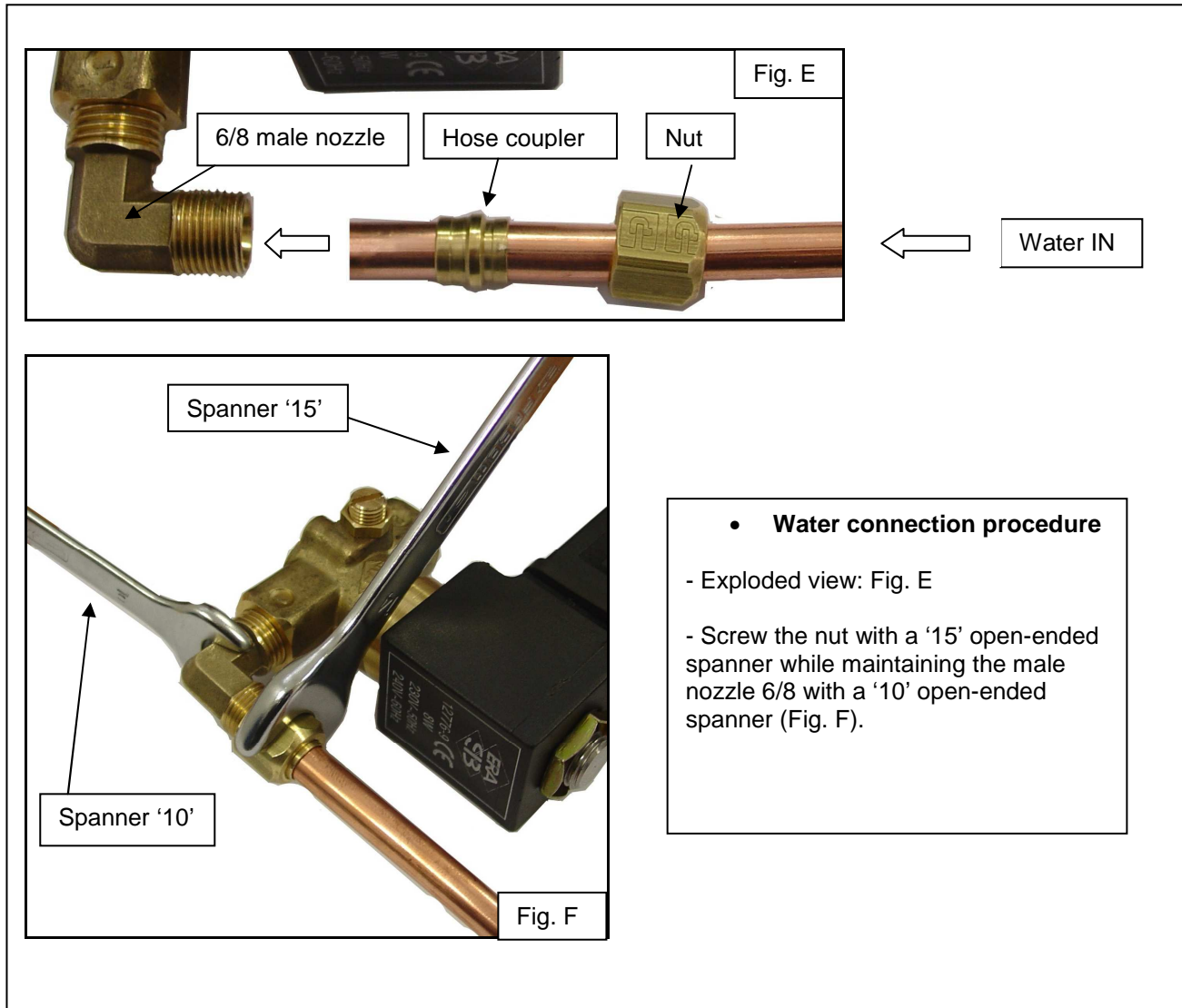

7. BASIC SPARE PARTS LIST

Description	Code	Photo	Description	Code	Photo
Oven injectors: G30,G31 propane gas ϕ 1.70 G20,G25 Natural gas ϕ 2.50	06205A 00209A		Thermocouple: Open burner Oven	 00291A 00290A	
Solid top injectors: G31 Propane gas ϕ 1.30 G20, G25 Natural gas ϕ 1.90	07105A 06985A		Solenoid valve for water tank	05405A	
Open burner injectors: G31 Propane gas ϕ 1.90 G20, G25 Natural gas ϕ 1.10	06985A 07145A		Transformer	02161A	
Gas tap for open burners on: - gas oven - open base	00311A 08094A		Push button	03967A	
Thermostatic valve for oven	08425A		Control knob for : - electric ignition - water tank	02105A	
Pilot light for oven	07551A		Spark plug	07010A	
Pilot light injector for oven G30,G31 Propane gas ϕ 0.20 G20, G25 Natural gas ϕ 0.40	01157A 06430A		Thermostat	08426A	

User Operation and Maintenance Instructions For Gas Cooking Ranges

Description	PRO 800 Series	PRO900 Series
G3FN/PL	V01587	V01463
G3PL/FN	V01591	V01467
B-G3FN/PL	V01589	V01466
B-G3PL/FN	V01593	V01470
R-G3FN/PL	V01590	V01727
R-G3PL/FN	V01594	V01728



**2 OPEN BURNERS + 1 SOLID TOP ON GAS OVEN
(not contractual photograph)**





S U M M A R Y

1. INTRODUCTION	2
2. PRIOR TO STARTING UP.....	2
3. STARTING UP.....	3
3.1. OPEN BURNERS (1-2).....	3
3.2. SOLID TOP (3).....	3
3.3. GAS OVEN (4).....	4
3.4. WATER TANK.....	5
4. SWITCHING OFF.....	5
5. MAINTENANCE.....	6
5.1. CLEANING OF THE STAINLESS STEEL SURFACES.....	6
5.2. CLEANING OF THE OPEN BURNERS.....	6
5.3. CLEANING OF THE SOLID TOP.....	6
5.4. CLEANING OF THE OVEN.....	6
6. POSSIBLE CAUSES OF BREAKDOWN.....	8
7. DATA PLATE.....	9

INTRODUCTION

- A) Our equipment is for professional use only and must be used by qualified staff.
- B) The equipment must be installed in compliance with local codes and bylaws. It must be installed in a kitchen equipped with an adequately sized mechanical extraction system.
- C) Units may be installed side by side or against walls of non combustible material. Distance to combustible material shall be no less than 10 cm.
- D) It is imperative to use a qualified engineer for all new installations or modifications of existing equipment.
- E) This instruction manual must be given to the user after installation.
- F) **WARRANTY:** The warranty is mentioned in our conditions of sale. It does not cover damage due to faulty installation, misuse or inadequate maintenance.

8. PRIOR TO STARTING UP

Before starting up it is advisable to clean the apparatus in order to remove all dust and impurities that have accumulated during storage.

Remove all plastic protection on stainless steel surfaces.

Make sure all the control knobs are in working order before opening the gas tap.

CONTROL PANEL

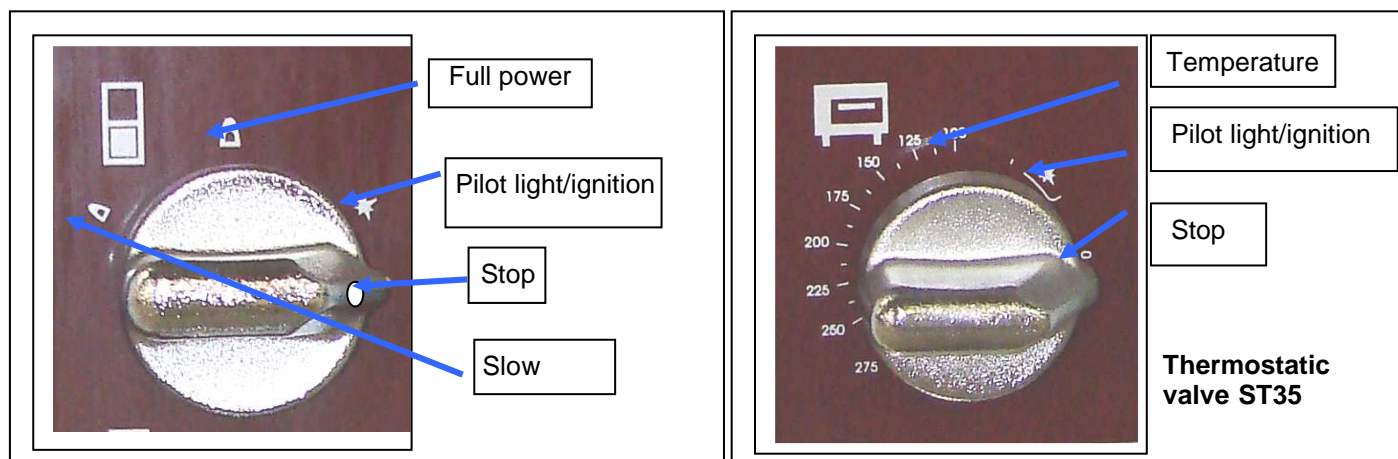

Do not heat the cooking surfaces unless they are in use as this may cause overheating then deterioration.



9. STARTING UP

Each burner is equipped with a flame failure safety cut out thermocouple and a pilot light.

9.1. Open burners (1-2)

- Push and turn control knob counter-clockwise of desired burner to the spark symbol (pilot light).
- Push the knob while igniting the desired burner or push the ignition button if the appliance has one (fitted as an option).
- Keep the knob pressed for about 5 to 15 seconds before releasing it.
- The pilot light must stay ignited. Try again if it did not work the first time.
- When the pilot light is on, turn the knob to the left up to the larger flame mark, the burner is now working at its full power (see Control Panel p. 2).
- By turning the knob to the next position (on the smaller flame mark), the power is slowed down.

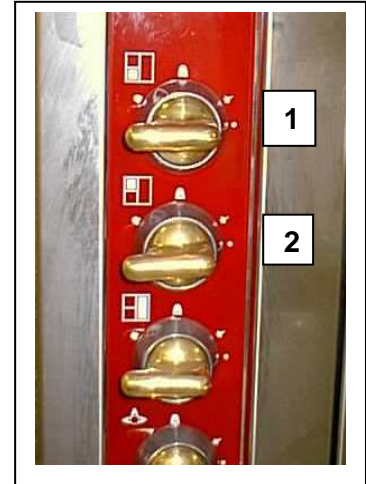

9.2. Solid top (3)

- Remove the cover.
- Push and turn control knob of desired burner (mark "P") to the left until you reach the spark mark.
- Push the knob while igniting the desired burner or push the ignition button for electric ignition appliances.
- Keep the knob pressed for about 5 to 15 seconds before releasing it. The pilot light must stay ignited. Try again if it did not work the first time.
- When the pilot light is on, turn the knob to the left up to the larger flame mark, the burner is now working at its full power.
- Turning the knob to the next position (on the smaller flame mark) the power is slowed down.
- Replace the cover.



9.3. Gas oven (4)

- Open the oven door.
- Check that you can reach the pilot light through a hole located at the front left hand side of the mild base.
- Push and turn the control knob counter-clockwise of desired burner (Fig. 3, G) until the arrow on the knob is opposite the spark symbol.
- Push the knob while igniting the burner through the hole or push the ignition button if the appliance has one (fitted as an option).
- Keep the knob pressed for about 5 to 15 seconds before releasing it.
- The pilot light must stay ignited. Try again if it did not work the first time.
- When the pilot light is on, turn the knob to the left up to the larger flame mark, the burner is now working at its full power (see Control Panel p. 2).
- Turn the thermostat knob (5) to the desired temperature; the oven burner is at its full power.
- Close the oven door.

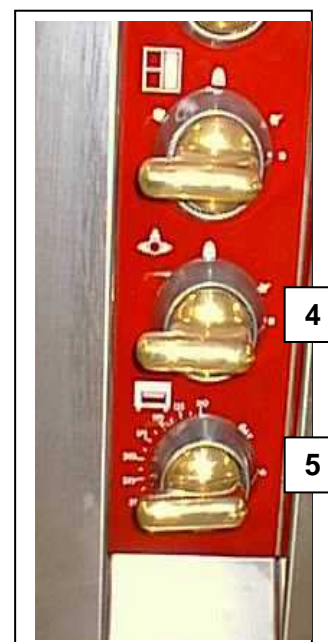

Attention! Side panels and oven door may be extremely hot after a prolonged or intensive use. Be careful to open the door only with the handle.



9.4. Water tank

Fig. I : water

Fig. K

<p>PUSH BUTTON Only water tank or electric ignition</p>	<p>CONTROL KNOB Water tank + electric ignition</p>
--	---

Fig. L

- **Checks before use**
 - The sluice gate must be positioned in the middle of the water tank (Fig. I).
- **Use procedure**
 - Press push button or turn control knob (Fig. L).
 - Fill with water to level MAXI of the sluice gate (Fig. K).
 - Check the waterproofness of the water connection circuit.
- **After use**
 - Take off the overflow device to empty the water tank.

10. SWITCHING OFF

Bring the control knobs back to the ● position as well as the oven thermostat.

At the end of the day, cut off gas supply or switch off electricity at the mains.



11. MAINTENANCE

Wait until the apparatus has cooled down before doing anything on it. The mains must be cut off.

11.1. Cleaning of the stainless steel surfaces

- Wash with a sponge in soapy water (or any other neutral cleaning product).
- Do not use bleach or any other acidic product – even well diluted.
- For the tops, use a nylon scouring pad if necessary. Always go with the grain.
- Clean with a greasy cloth to avoid rusting. Finger marks can be removed with a cloth dabbed with alcohol.
- The sluice gate must be put back in place after each cleaning.

5.2. Cleaning of the open burners

- Remove the pan supports, the crowns and the spillage tray.
- Wash the crowns and the spillage tray, rinse and dry. Then, clean with a greasy cloth to avoid rusting.
- Before putting back ensure that the support for the crowns are in the correct position.

5.3. Cleaning of the solid top



Never pour cold water or ice on the solid top (covers and rings) as this will deform or even crack the cast iron. Turn off gas and allow cooling before cleaning.

- A griddle scraper or wire brush can be used to remove burnt on particles. In extreme cases remove the covers and rings and soak in hot soapy water in a pot sink.
- Detergent filled wire pads may be used to remove final spillage once softened.
- Rinse and dry all surfaces thoroughly. Wet cast iron will rust! The top surface can be seasoned with a thin coating of vegetable oil – beware this will smoke when first heated.
- Remove the covers and rings to reach the refractory cement heat retention trays for cleaning. Brush carefully with a wire brush, pushing the debris through the central hole into the spillage tray below.

5.4. Cleaning of the oven

- Clean daily the internal sides of the oven to avoid smoke due to grease deposits or spotting.
- The mild base can be removed for easy cleaning and for access to the burner housing (see picture B p. 26).
- The enamelled steel removable shelf supports can be plunged in soapy water (see picture A, p. 26).

All the above cleaning operations are handled with a sponge in soapy water (or any other neutral cleaning product).

- Rinse, dry all the parts and put them back in correct position.

Please find here under the weight of some parts:



Description	Weight (kg)
Mild base*	23 kg
Cast iron pan support*	10.6 kg
Oven shelf	3.2 kg
Water tank	3 kg
Shelf supports	2.6 kg

* heavy parts

• **Removing procedure of the oven parts**

- Pull the oven shelf towards oneself (A).
- Put the fingers in the hole of the oven mild base and pull it towards oneself (B).

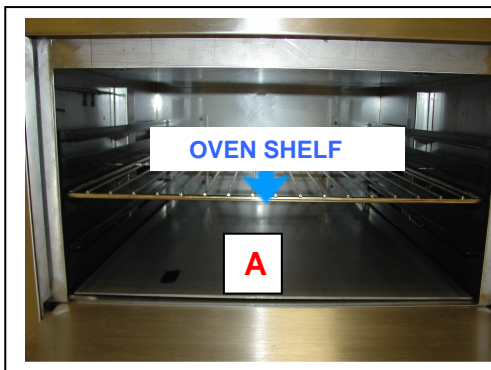

- Lift the removable shelf supports and pull to disengage them from the oven sides (1 & 2).
- Pull the removable shelf supports towards oneself (3).



This apparatus must not be cleaned with water under pressure or too much water splashed onto the burners as this might obstruct the gas supply.

For the electric ignition option, ensure that it is switched off at the mains.

For best results, have your equipment serviced and cleaned on a regular basis by a qualified installer (for the list of spare parts, see attached installation and set-up instructions).

CAUTION: Factory-sealed components must be serviced by neither installer nor user.



12. POSSIBLE CAUSES OF BREAK DOWN

<u>Breakdown</u>	<u><i>Probable causes</i></u>
Unsatisfactory heating	Clogging of the burners, injectors...
	Incorrect gas pressure
	Incorrect grading of the injectors
	Clogging of the rear internal flue box
Incorrect temperature of the oven	Faulty thermostat
Incorrect ignition	Clogging of the pilot light
	Clogging of the thermocouple
	Faulty thermocouples; incorrect flow of the pilot lights
	Incorrect position of the pilot lights
	The control knobs are not pushed far enough
Faulty electric ignition	Incorrect position of the spark plug



Contact the supplier to replace faulty parts.

Only a qualified electrician should replace the ignition transformers.

The manufacturer and the installer cannot be held responsible if the user neglects to ask for assistance in case of breakdown.



13. DATA PLATE

Transfer below information written on the data plate of your apparatus. This will help you with maintenance problems and spare parts.



CHARVET S.A.
38850 CHARAVINES

Réf.

Code: Type:

N°FC: Rep.

Cat.			
Gaz			
P (mbar)			
ΣQ_n (kW)			
ΣV_n (m ³ /h)			
ΣM_n (kg/h)			

U V Ip

f Hz P kW

CE

MADE IN FRANCE