

Electric deep fat fryer

AEROGAM Series :

Oil capacity 16 litres

√ **V01381 : ½AEROGAM E1FR1618HR**

Installation and set-up instructions



Electric deep fat fryer

1. INSTALLATION

1.1. General points

Installation must be undertaken in compliance with the following instructions and with local codes and bylaws.

The instruction manual must be given to the user after installation.

1.2. Handling

It is imperative to leave the appliance on its wooden pallet for handling on site until the final installation.

Unpack and check the apparatus for damage upon receipt.

In case of damage, mark delivery note accordingly and confirm this within 48 hours by registered letter with acknowledgement of receipt, with the haulage contractor.

1.3. Installation

(See technical notes)

This appliance must be installed under a suitable mechanical extraction hood.

If the apparatus is to be installed against a wall or partition, near a piece of furniture or decorative borders, it is recommended that these are made of fireproof material.

If this is not the case, they must be protected by an approved fireproof, insulating material.

All local fire regulations must be adhered to.

If in doubt about fireproof construction of adjacent walls, distance to combustible material shall be no less than 10 cm.

- Remove all plastic protection,
- Install the feet (they are delivered in a box kept inside the appliance),
- Adjust height of feet to level the unit to an horizontal working plan of 900 mm.

The equipment must be connected in compliance with the rules and regulations listed in this notice and with local bylaws.

Attention

Use a standardized cable (245 IEC 57 or 245 IEC 66) or any other cable with the same characteristics.

If the apparatus is permanently connected to a fixed electrical conduit, the supply should be equipped with an earth leakage circuit breaker.

If the apparatus is connected to a cable fitted with an electrical plug, the socket should be accessible at all times.

- Before connection :
 - Check that the electrical voltage of the supply is compatible with the voltage of the apparatus (see data plate).
 - It is recommended that the supply is fitted with an earth leakage circuit breaker.

The apparatus is wired at the factory according to requirements notified at the time of order. For any change of voltage required during the lifetime of the apparatus consult the manufacturer.

1.4. Connection to voltage

- Monitoring and checks

Before proceeding ensure that :

- The supply voltage is compatible
- The cable is fixed properly
- The connections are tight enough
- It is earth wired
- The cable is suitable for the power requirements
- The electrical equipment is properly insulated
- The electrical phasing of the supply is correct for the appliance.



Electric deep fat fryer

- Operation

(See part relating to service operation for users)



**Never put the apparatus into operation with an empty tank.
For trials without oil fill up the tank with water at the appropriate levels.**

- Connection

- Dismantle front control panel to reach the terminal box (fixed with clips),
- Thread cable through right hand side panel of the frame, enter terminal box through back opening,
- Connect supply cable to terminal by following diagrams below, making sure to follow instructions on the box,
- Before reassembling inspect all cables for damage.

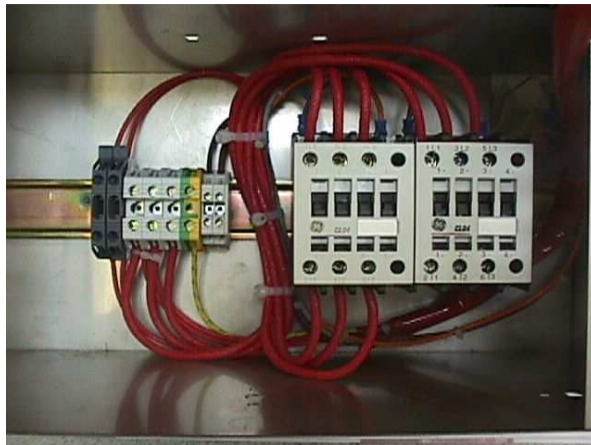

WIRING DIAGRAM

Apparatus	Voltage	N° electrical diagram
EFR 16/18HR	3 ~ 400 V + PE	SE0010 / 00
Electronic regulation	3 ~ 400 V + PE	SE0026 / 00



**The apparatus must be earth wired. It is dangerous to connect the apparatus without earth connection.
We cannot be held responsible for accidents due to non existent or incorrect earth link connection.**

2. INTERVENTIONS



**Any breakdown action on an apparatus must be undertaken by a qualified technician.
The apparatus will have to be isolated from the electrical supply for the duration of this work.**

Electric deep fat fryer

2.1. Hand over

When the apparatus is ready for use, ensure the users know how to use it properly (see users information). Formerly give the person in charge all documentation needed.

2.2. Reactivation of the high limit security thermostat

The fryers are equipped with a high limit security thermostat to protect the apparatus against overheating caused by :

- A fault with the regulating thermostat,
- A fault with the contactor,
- An inadequate filling of the tank.

-> The reactivation is done by pushing the red button of the security thermostat which is accessible by opening the cover of the element.

Reactivation of the high limit thermostat

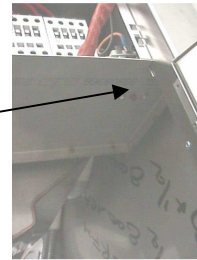

Attention ! The operation of the security thermostat must be analysed before reactivation.

2.3. Identification of the apparatus :

Each apparatus has its own identification data plate. Transfer the information on the data plate to the part of the instruction manual reserved for it .

Data plate

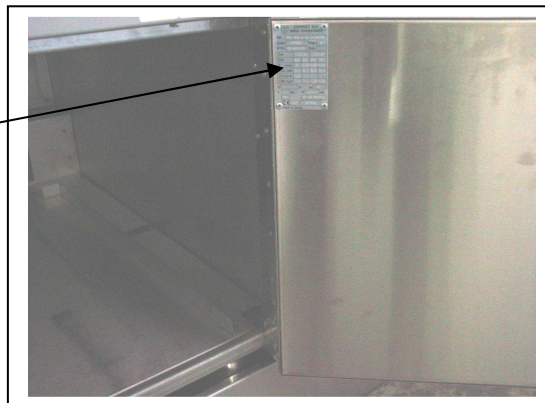









Warranty :

The warranty is specified on our conditions of sale.

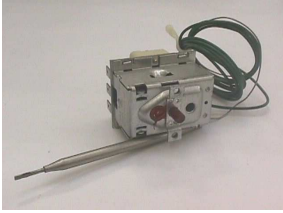
This warranty does not cover damages due to incorrect installation, misuse or inadequate maintenance .

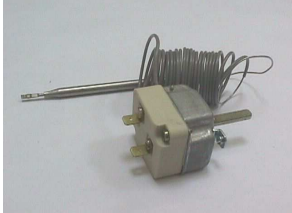
Electric deep fat fryer

3. BASIC SPARE PARTS LIST

Description	Code	Part	Description	Code	Part
Element 18 kW for EFR 16/18	02055A		Indicators . red . yellow	02131A 05075A	
Three phase high limit thermostat	05996A		Fuse 5 mm x 20 mm 5 A	03413A	
Bulb 400 V Bulb 230 V	02142A 02141A		Regulating thermostat	01996A	
Switch	02104A		Contactor 400 V	02200A	
Mechanical timer	02167A				

Electric deep fat fryer

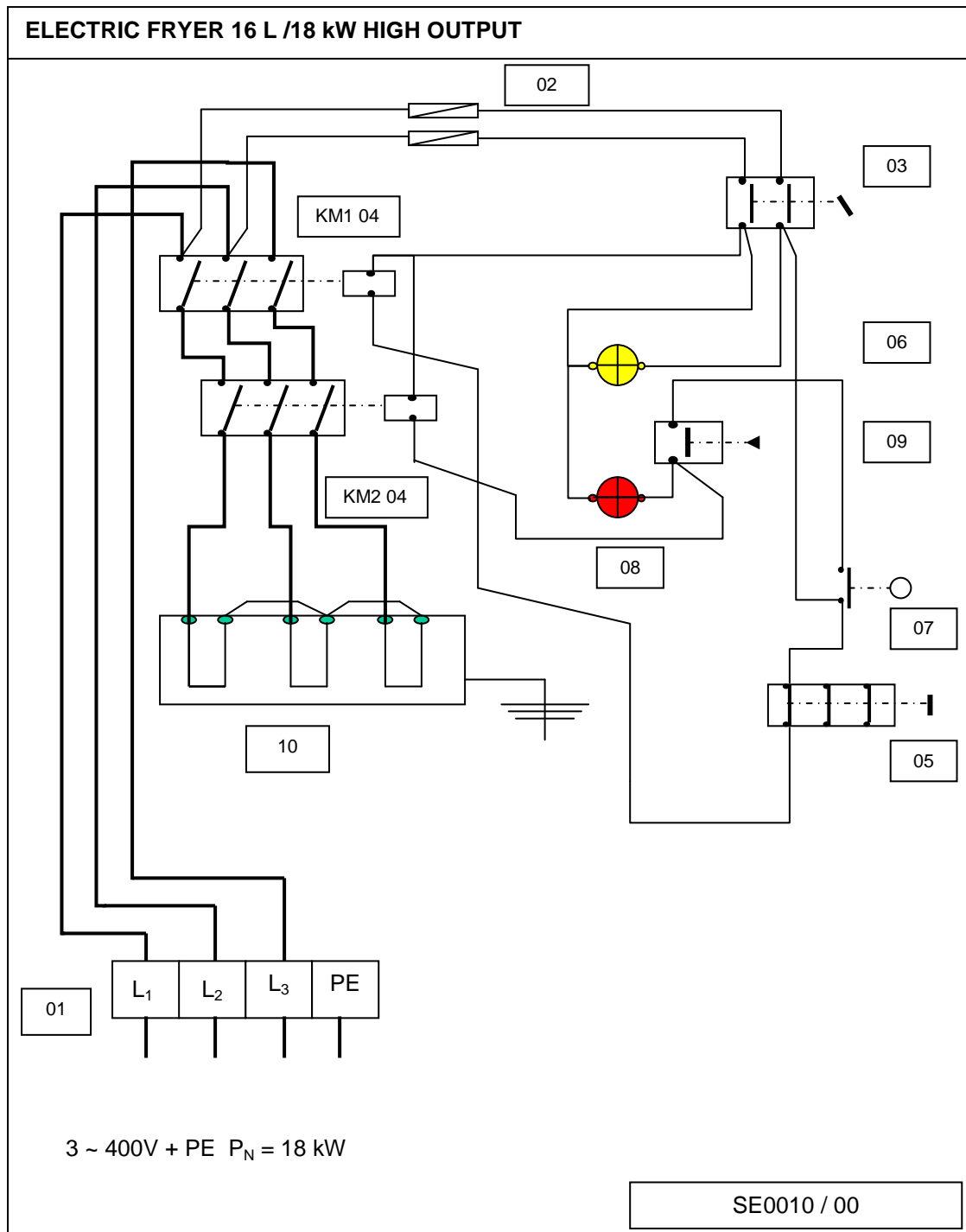

Electric deep fat fryer

NOMENCLATURE : ELECTRIC FRYER 16 L/18 kW (diagram : SE0010 / 00)

Mark	Code No	Description	Quantity
01	02468A	10 A terminal box (brand : Viking)	3
01	03575A	10 A terminal box (brand : Viking)	1
01	02466A	4 A terminal box (brand : Viking)	1
02	02726A	5 mm x 20 mm fuse support	2
02	03413A	5 mm x 20 mm - 5 A fuse	2
03	02104A	Switch with handle	1
04	02200A	55 A 400 V contactor	2
05	05996A	Safety thermostat	1
06	05075A	Yellow high temperature indicator	1
06/08	02142A	400 V bulb for indicator	2
07	05091A	Micro switch for element	1
08	02131A	Red high temperature indicator	1
09	01996A	Thermostat	1
10	07038A	12 kW 230 400 V element	1



Electric deep fat fryer

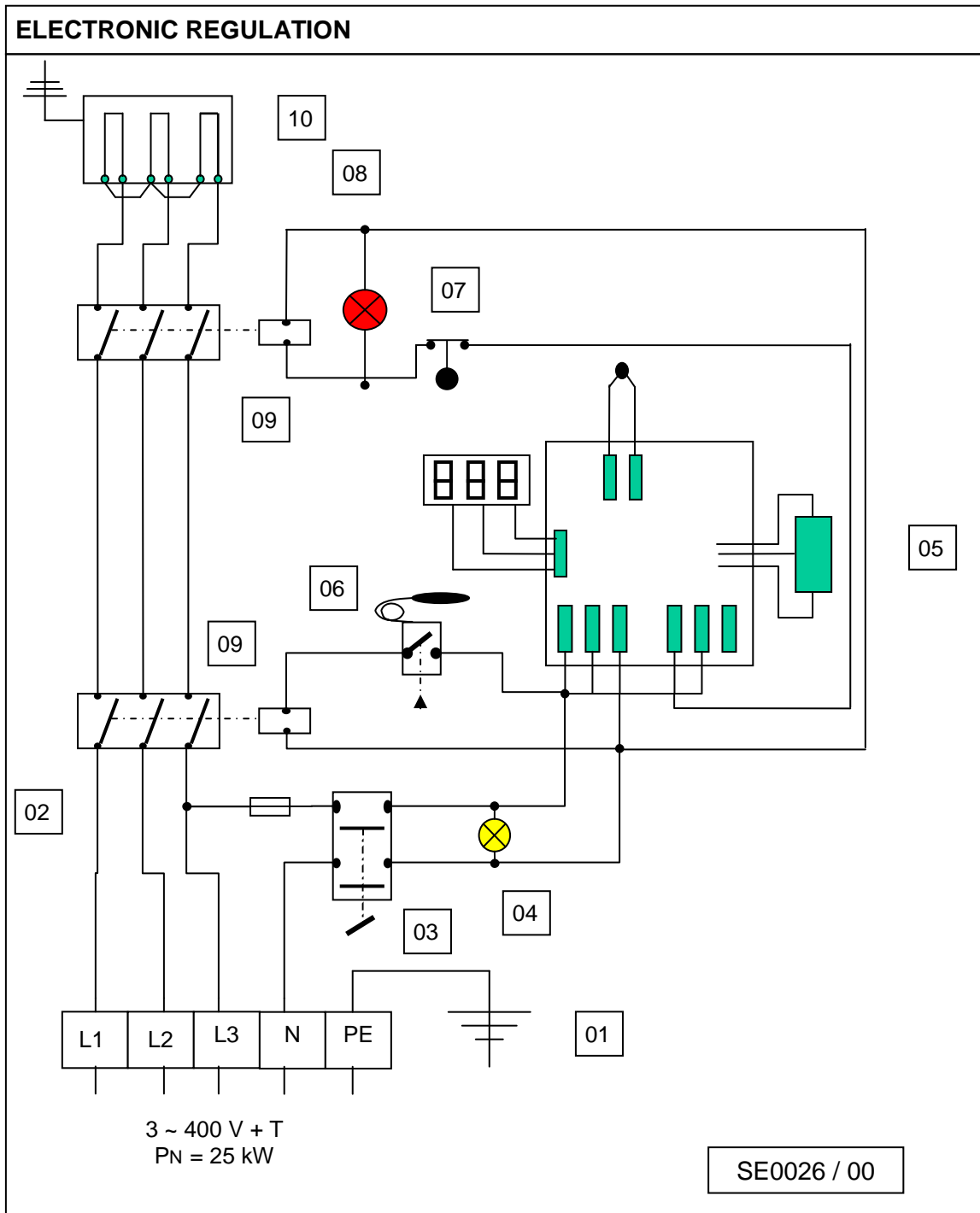

Electric deep fat fryer

NOMENCLATURE : ELECTRONIC REGULATION (diagram : SE0026 / 00)

Mark	Code	Description	Quantity
01	02468A	10 A terminal box	3
01	03567A	10 A terminal box	1
01	07069A	Blue terminal box	1
02	03413A	Fuse 5 mm x 20 mm, 5 A	1
03	02104A	Switch	1
04	05075A	Yellow indicator	1
05	05771A	Electronic card	1
06	05996A	Safety thermostat	1
07	05091A	Micro switch for element	1
08	02131A	Red indicator	1
04/08	02141A	Bulb 230 V	2
09	02200A	Contacteur 400 V	2
10	05598A	Element 25 kW 400 V	1



Electric deep fat fryer

AEROGAM Series :

Oil capacity 16 litres

√ **V01381 : ½AEROGAM E1FR1618HR**

Operating and maintenance instructions



Electric deep fat fryer

Dear client,

Thank you for choosing **Charvet**.

We have compiled this users instruction leaflet to enable you to quickly become familiar with this equipment.

We would recommend that you read the instruction leaflet thoroughly before use.

This leaflet includes information, useful tips and advice to enable you to use your equipment to its full potential.

We are certain that by following these instructions you will be soon acquainted with your new **Charvet** equipment and that it will give you entire satisfaction for a very long time.

Yours faithfully.



Electric deep fat fryer

1. INTRODUCTION

- A) Our equipment is for professional use only and must be used by qualified staff.
- B) The equipment must be installed in compliance with local codes and bylaws. It must be installed in a kitchen equipped with an adequately sized mechanical extraction system.
- C) Units may be installed side by side or against walls of non combustible material. Distance to combustible material shall be no less than 10cm.
- D) It is imperative to use a qualified engineer for all new installations or modifications of existing equipment.
- E) This instruction manual must be given to the user after installation.
- F) Warranty :The warranty is mentioned in our conditions of sale. It does not cover damage due to faulty installation, misuse or inadequate maintenance.

2. PRIOR TO INITIAL START UP

- Before filling the tank with oil, clean it by boiling soapy water in the tank in order to eliminate all impurities that have accumulated during storage,
- Drain,
- Make sure that the tank is thoroughly dried before filling with oil,
- Before connecting the elements, make sure the oil level in the frying tank is correct :
 - EFR 14/12 : between marks situated on the basket holder (max. ●●, min. ●),
 - EFR 16/18 : between the ends (top and bottom) of the graduation situated on the side of the tank,
 - Under minimum level, there is a risk of overheating,
 - Above maximum level, there is a risk of overflowing when the basket is lowered in the tank.



Remember to turn off the elements and allow to cool before each drainage prior to cleaning.

3. START UP

3.1. Open the lid :

- Turn the switch to the 'ON' position, the yellow light comes on (sign that it is connected).
- Select desired temperature by using the thermostat knob (see table on the fryer door), the red light comes on. The apparatus is connected.
- The red light will go off when the desired temperature is reached. The frying basket can then be placed in the oil.

3.2. Temperatures, heating up time, cooking time :

PRODUCTS	HEATING UP TIME	FRYING TEMP. IN DEG.C	COOKING TIME IN MIN.
BLANCHED POTATOES 1ST IMMERSION	5 – 5'30	150° - 170°	3 – 5
GOLDEN POTATOES 2 ND IMMERSION	5'30 – 6'30	170° - 190°	2 - 3
FRIES	6'30	190°	2 - 4
FISH	5'30 – 6'30	170° - 190°	2 - 5
MEAT	5'30 – 6'30	170° - 190°	2 - 3
DESERTS	6'	180°	2 - 5

These times are only indicative ; they vary depending on the oil quality, the quantity, and the temperature of the products put into the baskets.



Electric deep fat fryer



**Preheating of the bath with solid fat bars.
Never melt solid fat bars on the elements (melt these beforehand).**

Pre-heating of solid fat is done with the thermostat on low setting (60 degrees Centigrade) during the whole melting process (this is to eliminate the risk of the fat catching fire around the element and activation of the high limit thermostat).

Practical advices

The fryer allows a great variety of frying. Avoid overloading the baskets :

MODEL	LOAD IN KG FRESH FRIES	LOAD IN KG 6x6 PRE-COOKED FRIES	FROZEN	NUMBER OF BASKET(S)
EFR 14/12	3	2.5		1
EFR 16/18	4	2.5		1

Your fryer is equipped with :

- A mechanical timer will help you to plan cooking time by programming the desired time. At the end of it a sound will inform you when to remove the basket.
- A hook to hang the basket to facilitate drainage, during cooking the basket rests on the element.
- A cold zone to allow the impurities to settle and not burn in the tank, resulting in a need to change the cooking oils less frequently.
- A drain tap over drip tray fitted with a filter allowing drainage of the tank as well as primary oil filtration.

The tap is fitted to the underside of the oil tank and accessible via the lower cupboard. Allow oil to cool before draining.

Attention ! The sides of the tank can be very hot after prolonged and intensive use. The handles of the draining tank will also be very hot if hot oil is being drained.

3.3. Switching off :

- Bring thermostat back to "0" position,
- At the end of the day switch the electricity off.

4. MAINTENANCE

4.1. Cleaning of the stainless steel covers :

- Use a sponge with soapy water or any other neutral cleaning agent. *Do not use bleach or any other acidic product even well diluted.*
- For the tops use if necessary a scouring pad making sure you follow the grain of the polish.
- After each cleaning rub with a greased cloth or kitchen paper.
- Finger marks be removed with a cloth dabbed in alcohol.

4.2. Cleaning of the tank :

- Switch off the fryer, allow the oil to cool and drain the tank. Then fill up the tank with water and a neutral cleaning agent or a product specially designed for fryers.
- Heat up at low temperature (60 deg C.).
- Switch off the apparatus again, drain and rinse the tank.



Electric deep fat fryer

Attention ! This apparatus must not be cleaned with mechanical water jets or be subjected to a deluge of water splashes. Your fryer is equipped with a removable element, do not immerse the block above the filling level. Before undertaking any cleaning operations make sure the apparatus is not connected.

For better service regular maintenance by qualified staff is recommended depending on the intensity of use.

6. POSSIBLE CAUSE OF BREAKDOWN



- In case of breakdown of the regulating thermostat, a limiting thermostat will control the temperature, cut the power to the elements in plenty of time, and ensure the fryer is secure.
- Contact the supplier to replace the thermostats or the elements.



Only a qualified electrician should replace the thermostats or elements.

The manufacturer and the fitter cannot be held responsible if the user neglects to ask for assistance in case of break down.

Transfer below information written on the data plate of your apparatus.

		CHARVET S.A.	
		38850 CHARAVINES	
Réf.	<input type="text"/>		
Code:	<input type="text"/>	Type:	<input type="text"/>
N°FC:	<input type="text"/>	Rep.	<input type="text"/>
Cat.	<input type="text"/>	<input type="text"/>	<input type="text"/>
Gaz	<input type="text"/>	<input type="text"/>	<input type="text"/>
P (mbar)	<input type="text"/>	<input type="text"/>	<input type="text"/>
ΣQ_n (kW)	<input type="text"/>	<input type="text"/>	<input type="text"/>
ΣV_n (m ³ /h)	<input type="text"/>	<input type="text"/>	<input type="text"/>
ΣM_n (kg/h)	<input type="text"/>	<input type="text"/>	<input type="text"/>
U	<input type="text"/>	V	<input type="text"/>
f	<input type="text"/>	Hz	<input type="text"/>
	<input type="text"/>	P	<input type="text"/>
	<input type="text"/>	kW	<input type="text"/>
		<input type="text"/>	
MADE IN FRANCE			

This will help you with maintenance problems and spare parts

Ets CHARVET S.A.
1170 rue Principale
38850 CHARAVINES
Tel. (33) 4 76 066 422
Fax (33) 4 76 557 875
E-mail : info@charvet.fr



NOTICE : AEROGAM UK EFR1618HR
ind : A . Edited on : 05/02/2003