

GAS-FIRED TILTING BRATT PAN

AEROGAM series

50-LITRE AND 80-LITRE BRATT PANS



Photograph: G1SBM80I

- ✓ V01360 - V01753 : AEROGAM G1SBM50I, G1SBM50I/D
- ✓ V01313 : AEROGAM G1SBM80I

Installation and set-up instructions

GAS-FIRED TILTING BRATT PAN

1. INSTALLATION

1.1. General points

Installation must be undertaken in compliance with the following instructions and with local codes and bylaws.

The instruction manual must be given to the user after installation.

1.2. Handling and installation

It is imperative to leave the appliance on its wooden pallet for handling on site until the final installation.

Unpack and check the apparatus for damage upon receipt.

In case of damage, mark delivery note accordingly and confirm this within 48 hours by registered letter with acknowledgement of receipt, with the haulage contractor.

1.3. Installation

(See technical notes)

This appliance must be installed under a suitable mechanical extraction hood.

If the apparatus is to be installed against a wall or partition, near a piece of furniture or decorative borders, it is recommended that these are made of fireproof material.

If this is not the case, they must be protected by an approved fireproof, insulating material.

All local fire regulations must be adhered to.

If in doubt about fireproof construction of adjacent walls, distance to combustible material shall be no less than 10 cm.

Remove all plastic protection.

Install the flue on top of the appliance and ensure the flue is free of obstruction.

• Fixed appliance

- Install the feet (they are delivered in a box kept inside the appliance).
- Adjust height of feet to level the unit to a horizontal working plan of 900 mm.

• Mobile appliance

Install the appliance close to the gas supply for easier connection.

The castors with brakes must be locked when the appliance is being connected and during cooking times.

1.1. Montage de la mitre

Insérer une patte de fixation de la mire dans l'appareil.

Pousser la seconde patte à l'aide d'un outil.

Serrer les vis dans le chapeau de mitre.

1.4. Gas connection

- The appliance must be connected in a well ventilated area in compliance with the rules and regulations listed in this notice and with local codes and bylaws.
- This unit is of the A-type and shall not be connected to a flue gas pipe.
- Atmospheric combustion air supply shall be 7.8 cubic meters/hour (2 cubic meters per kW of heat released). Also see table 2.



GAS-FIRED TILTING BRATT PAN

ATTENTION:

Only use authorized material for assembling and welding (EN 45 204). All connections to be in accordance with local regulations.

- **Fixed appliance**

Connect the burner strip to the gas mains using 1/2" NPT pipe and connections. Install a shutoff valve in the supply line allowing the unit to be isolated from the rest of the system (check table below for pipe diameters).

- **Mobile appliance**

Connect a 1/2" approved armoured flexible gas hose equipped with a quick disconnect fitting including automatic gas shut off to the gas connection located on the rear of the appliance. Remember to use the security chain.

- **Before connection**

Ensure that the gas supply pipe is of the correct size for minimum pressure drop as a function of length, elbows and total unit capacity. Supply pressure should match that shown on the type plate for the gas used.

1.5. Power connections

Electrical connection is used for the bratt pans equipped with an electrical pan tilt and electrical lighting.

The equipment must be connected in compliance with the rules and regulations listed in this notice and with local codes and bylaws.

ATTENTION:

Use a standardized cable (245 IEC 57 or 245 IEC 66) or other approved cable with the same characteristics.

- **Fixed appliance**

The apparatus being permanently connected to a fixed electrical conduit, the socket should be equipped with an earth circuit breaker.

- **Mobile appliance**

The apparatus being connected to a cable fitted with an electrical plug, the socket should be accessible at all times.

- **Before connection**

Check that the electrical voltage of the supply is compatible with the voltage of the apparatus (see data plate).

It is recommended that the supply is fitted with an earth leakage circuit breaker, the distance between switches must be of 3.5 mm in compliance with the norm EN 60335-1 of May 2003.

The apparatus is wired at the factory in single phase 230V + Earth or in three phase + Neutral + Earth.

2. CONVERSION TO OTHER TYPES OF GAS :

(In case of a different type of gas from the one used normally).

2.1. Replacing burner nozzles :

See chart below according to the burners:

- To choose the correct diameter depending on the nature of the gas,
- To get the right air adjustment for the air ring on the burner.

Changing the injectors upon installation: When done, ensure of the waterproofness of the connection between the injector and its support.

2.1.1. 50-litre bratt pan

Adjustment	Gas type & operating pressure	Mark engraved on the injector	Air adjustment d (mm) ²	Calorific output in kW ¹
1	G 20 : Pn = 20 mbar	400	3	25.6
2	G 25 : Pn = 20 mbar			
3	G 25 : Pn = 25 mbar			
4	G 30 : Pn = 29 mbar			25.6
5	G 30 : Pn = 50 mbar			
6	G 31 : Pn = 37 mbar	250	6	
7	G 31 : Pn = 50 mbar			



GAS-FIRED TILTING BRATT PAN

2.1.2. 80-litre bratt pan

Adjustment	Gas type & operating pressure	Mark engraved on the injector	Air adjustment d (mm) ²	Calorific output in kW ¹
1	G 20 : Pn = 20 mbar	2 x 340	3	41.9
2	G 25 : Pn = 20 mbar			
3	G 25 : Pn = 25 mbar			
4	G 30 : Pn = 29 mbar	2 x 230	9	41.9
5	G 30 : Pn = 50 mbar			
6	G 31 : Pn = 37 mbar			
7	G 31 : Pn = 50 mbar			

- ¹ : Measured power over lower calorific power of the gas
- ² : Regulation of air according to diagram 1

2.1.3. Pilot light

Adjustment	Gas type & operating pressure	Mark engraved on the injector
1	G 20 : Pn = 20 mbar	40
2	G 25 : Pn = 20 mbar	
3	G 25 : Pn = 25 mbar	
4	G 30 : Pn = 29 mbar	20
5	G 30 : Pn = 50 mbar	
6	G 31 : Pn = 37 mbar	
7	G 31 : Pn = 50 mbar	

2.2. Air adjustments

2.2.1. 50-litre bratt pan

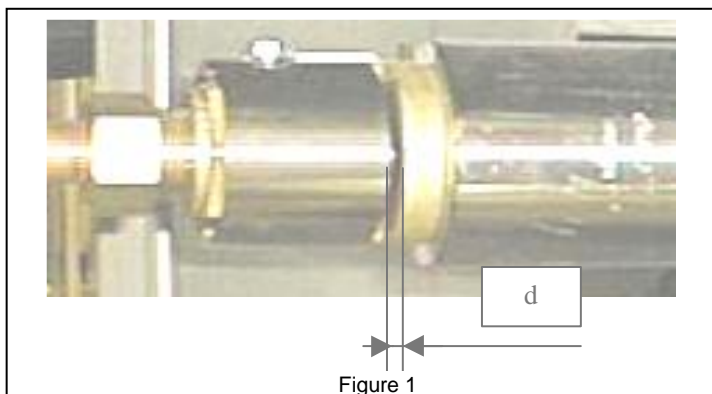
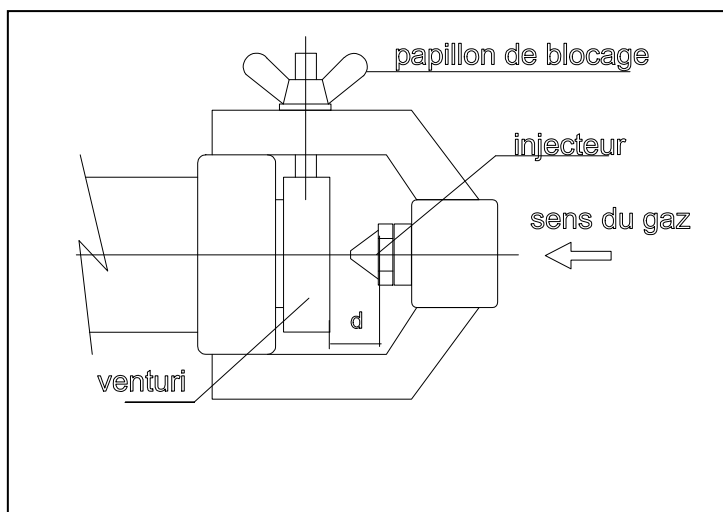

Figure 1

Remove the control knob.
 Remove control panel (fixed by 4 clips on lower part).
BEWARE OF ELECTRIC CABLES.
The pilot and air ring are accessible.
 Loosen and remove the air ring.
 Change the injector.
 Adjust the air ring until "d" matches the desired value.
 Tighten the air ring.

GAS-FIRED TILTING BRATT PAN

2.2.2. 80-litre bratt pan



Remove the control knob.
Remove control panel (fixed by 4 clips on lower part).
Pull down to disengage the higher clips.
BEWARE OF ELECTRIC CABLES
The pilot light and the venturi are accessible.
Loosen the butterfly.
Remove the venturi.
Change the injector.
Adjust the venturi until « d » matches the desired value.
Tighten the butterfly.

Legend:

- Papillon de blocage: *butterfly*
- Injecteur: *injector*
- Sens du gaz: *gas in*
- Venturi: *venturi*

2.3. Electric controls (when fitted) and checks

(Electric ignition & sequential burners are considered as options)

Before proceeding ensure that:

- The supply voltage is compatible,
- The cable is fixed properly,
- The connections are tight enough,
- It is earth wired,
- The section of the cable is suitable for the power,
- The electrical equipment is properly insulated,
- The electrical phasing of the supply is correct for the appliance.

2.3.1. Adjustments

No adjustment is normally necessary for the electric ignition system.

2.3.2. Operation

See section relating to service for users.



**Never use with empty tank.
The tank must be free of objects.
All the above operations are carried out when the apparatus is cold.**

GAS-FIRED TILTING BRATT PAN

2.4. Connections

GAS

M 1/2" threaded tube

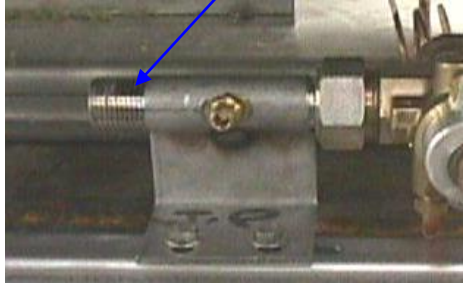

Remove the control knob.
Remove control panel (fixed by 4 clips on lower part).
BEWARE OF ELECTRIC CABLES.
Connect to tube M 1/2".

ELECTRICITY (Options)

Cable



The apparatus is delivered with a high temperature flexible cable.

Install a single phase 230 V + Earth or a three phase + Neutral + Earth or in three phase + Neutral + Earth.

Connect the apparatus.

- Before reassembling inspect all cables for damage.



**The apparatus must be earth wired.
It is dangerous to connect the apparatus unless it is earthed.**

We cannot be held responsible for accidents due to non-existent or incorrect earth link connection.

WIRING DIAGRAMS:

Option	Voltage	No electrical diagram
Control system and lighting	1 ~ 230 V + PE	SE0028 / 00

3. SERVICING AND MAINTENANCE



Any breakdown action on an apparatus must be undertaken by a qualified technician.

The apparatus will have to be isolated from the electrical or gas supply for the duration of the work.

When the apparatus is ready for use ensure the users know how to use it properly (see users guide). Formerly give the person in charge all documentation needed.

GAS-FIRED TILTING BRATT PAN

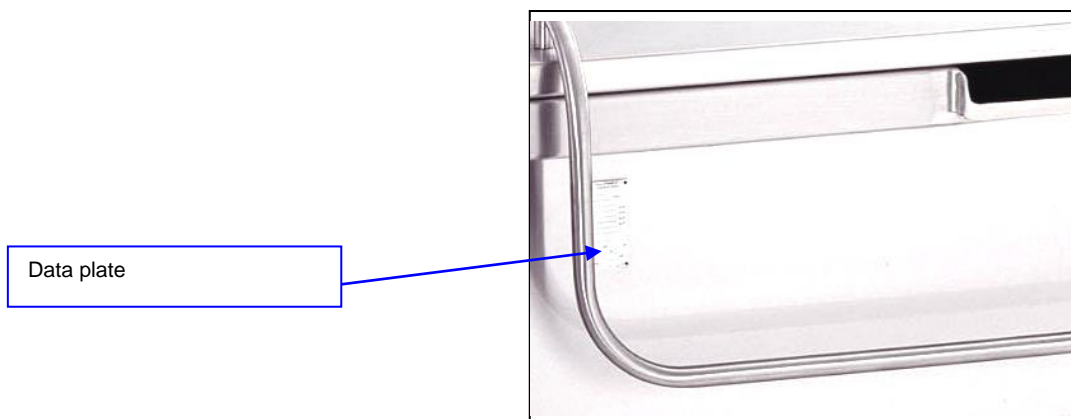

Each apparatus has its own data plate. Transfer all the information on the data plate to the part of the instructions booklet reserved for it.

The data plate will ease the communication between you and your client for better service.

WARRANTY:







The warranty is specified on the conditions of sale and does not cover damage due to incorrect installation, misuse or inadequate maintenance.

GAS-FIRED TILTING BRATT PAN

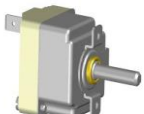
4. BASIC SPARE PARTS LIST

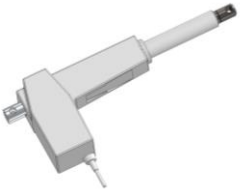
Description	Code	Parts	Description	Code	Parts
Electrode(s)	05315A		Pilot injectors: - Natural - Propane	07357A 06430A	
Thermocouple	F15948		Coil thermocouple valve	00325A	
Ignition transformer	02161A		Connection cable High Voltage electrode / transformer	174004	
Energy regulator 230 V Or 400V	09099A 09088A		Volant	502910	
3-flame pilot light: Natural Propane	07551A 07550A		Injectors 80-litre bratt pan: Ø 4.00 Natural Ø 2.50 Propane	00224A 00209A	
Injectors 50-litre bratt pan: Ø 3.40 Natural Ø 2.30 Propane	00218A 00207A		Robinet gaz	05071A	
Electrovanne gaz	507649		Brûleur sauteuse 50dm2 Brûleur sauteuse 80dm2	F10020 F10018	

GAS-FIRED TILTING BRATT PAN

Thermostat 300°	506245		Fin de course	505852	
Vérin	08785A		Boitier de contrôle	08786A	
Câble vérin	08787A		Bouton poussoir	ELE0018	
Voyant vert 230v Voyant orange 230v Voyant blanc 230v	173642 173640 173641				

GAS-FIRED TILTING BRATT PAN

NOMENCLATURE:



Schéma électrique n° : SCE0192
 Indice dernière révision :
 Auteur dernière révision :
 Date dernière révision : 20/07/2020



AEROGAM - 1000 sauteuse G1SBM/E 50 & 80 dm²

Applicable à : V02942 V02943 V01360 V01753 V01313 V02944

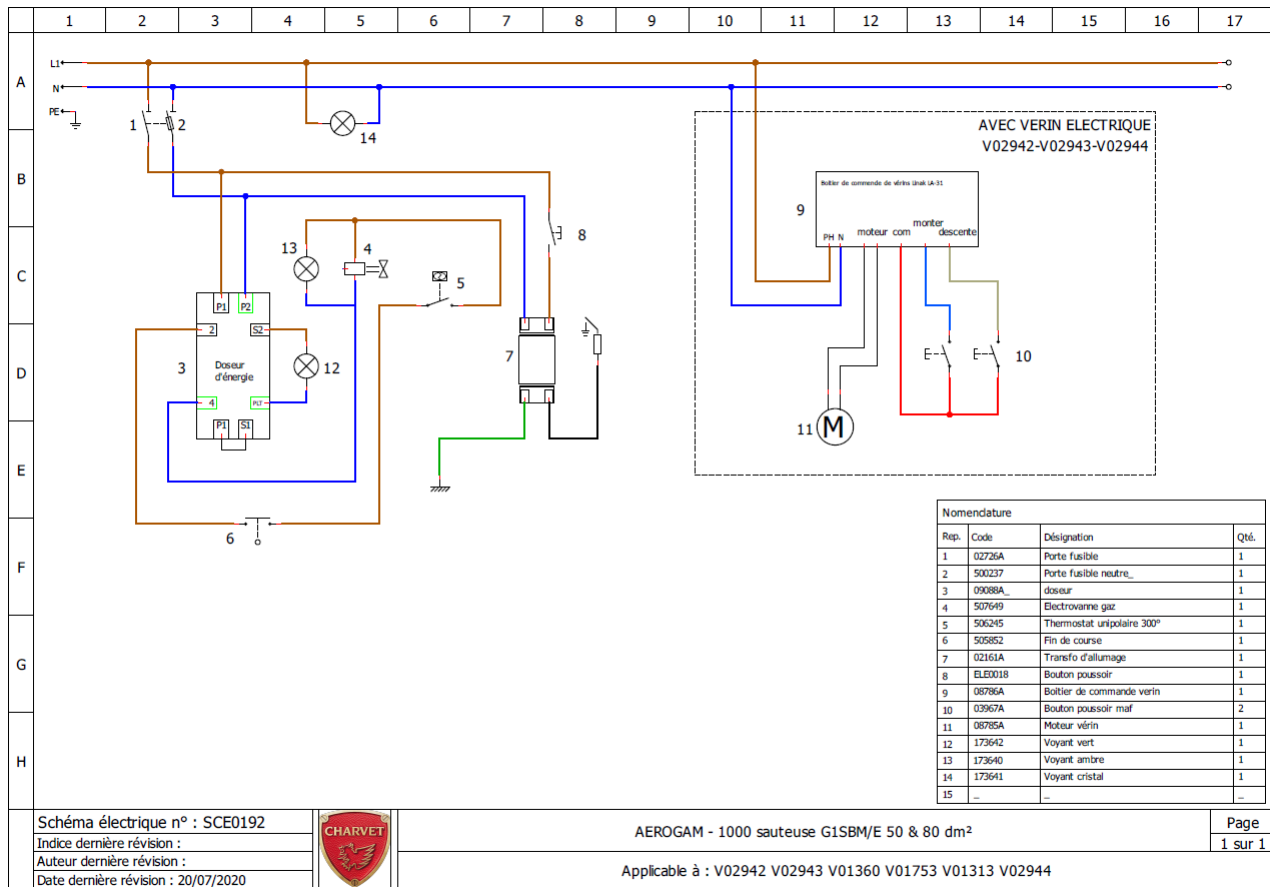
Page
1 sur 1



GAS-FIRED TILTING BRATT PAN

AEROGAM series

50-LITRE AND 80-LITRE BRATT PANS



Photograph: G1SBM80I

- ✓ V01360 - V01753 : AEROGAM G1SBM50I, G1SBM50I/D
- ✓ V01313 : AEROGAM G1SBM80I

User operation & maintenance instructions

GAS-FIRED TILTING BRATT PAN

Dear client,

Thank you for choosing **CHARVET**.

We have compiled this user instruction leaflet to enable you to quickly become familiar with this equipment.

We would recommend that you read the instruction leaflet thoroughly before use.

This leaflet includes information, useful tips and advice to enable you to use your equipment to its full potential.

We are certain that by following these instructions you will be soon acquainted with your new **CHARVET** equipment and that it will give you entire satisfaction for a very long time.

Yours faithfully,



GAS-FIRED TILTING BRATT PAN

1. INTRODUCTION

- A) Our equipment is for professional use only and must be used by qualified staff.
- B) The equipment must be installed in compliance with local codes and bylaws. It must be installed in a kitchen equipped with an adequately sized mechanical extraction system.
- C) Units may be installed side by side or against walls of non-combustible material. Distance to combustible material shall be no less than 10cm.
- D) It is imperative to use a qualified engineer for all new installations or modifications of existing equipment.
- E) This instruction manual must be given to the user after installation.
- F) **WARRANTY:** The warranty is mentioned in our conditions of sale. It does not cover damage due to faulty installation, misuse or inadequate maintenance.

Dimensions:

- G1SBM50I: L: 1000 mm x D: 1000 mm x H: 900 mm
- G1SBM50I/D: L: 1100 mm x D: 1000 mm x H: 900 mm
- G1SBM80I: L: 1500 mm x D: 1000 mm x H: 900 mm

Construction :

18-10 stainless steel one-piece frame, 1 to 3 mm thick, with electric welding.
18-10 stainless steel work top, 3 mm thick with 55 mm turn down to front.
18-10 stainless steel panels, 1 mm thick, assembled with no visible bolts.
Enamelled control panel with printed marking.
18-10 stainless steel tank with 10 mm thick base.
Integral front pouring spout.
Stainless steel lid with a tubular insulated handle on stainless steel spring hinges.
"Multi-ramp" burner with flame failure safety cut out thermocouple fitted on the pilot light.
Recessed low and high heat control.
400 mm high stainless steel legs with adjustable inox feet (+ 40 / - 00 mm), diam. 76.1 mm.

Tank:

18-10 stainless steel tank, 10 mm thick – front spout 2.5 mm thick. Internal dimensions:
- 50 dm² bratt pans: L: 730 mm x D: 680 mm x H: 250 mm.
- 80 dm² bratt pans: L : 1210 mm x D: 680 mm x H: 250 mm.
18-10 stainless steel lid, 1.5 mm thick, with a tubular handle and insulated nozzle on stainless steel spring hinges.
Manual wheel tilt.

Heating:

- 50 dm² bratt pans: enamelled « multi-ramp » burner rated 25.6 kW with pilot light and safety thermocouple.
- 80 dm² bratt pans: enamelled « multi-ramp » burner rated 41.9 kW, with two injectors, pilot light and safety thermocouple.
Recessed slow and high heat control.
Electric ignition by spark light and transformer.
Single phase (1 ~ 230 V + E) electric lighting controlled by push button (manual ignition still possible).
Pan tilt safety cut out.

Mixer water tap:

2-holes mixer water tap – G = 3/4" – distance between axes: 120 mm.
Cross-head: 1/4 turn.
Swivel spout L: 400 mm x H: 300 mm – spinning: 360°.
Flow: 86 l/mn under 3 bars.

Options:

Insulated lid on standard or counter balanced spring hinges.
BIMETAL 10 mm base (18-10 stainless steel 2 mm + 8 mm thick mild steel).



GAS-FIRED TILTING BRATT PAN

2. PRIOR TO STARTING UP

Information: The multi-ramp burner is equipped with a safety thermocouple and a pilot light.

- a) Remove all plastic protection on stainless steel surfaces.
- b) Make sure all the control knobs are in working order before opening the gas tap.
- c) Before starting up it is advisable to clean the apparatus in order to remove all dust and impurities that have accumulated during storage
 - Pour the tank with water for 1 to 2 cm deep.
 - Push and turn control knob of burner to the left until you reach the spark mark.
 - Push the knob while igniting the desired burner or push the ignition button for electric ignition appliances.
 - Keep the knob pressed for about 5 to 15 seconds before releasing it. The pilot light must stay ignited. Try again if it did not work the first time.
 - When the pilot light is on, turn the knob to the left up to the larger flame mark, the burner is now working at its full power.
 - Wait for about 10 minutes to heat the tank.
 - The power is slowed down when turning the knob to the next position (on the smaller flame mark).

a) Turn the thermostat until it reaches the desired temperature. The bratt pan is heating and the red indicator is alight.

b) Stop heating.

c) Drain the tank by tilting the pan: pull the handle to unlock the pan and push it down to tilt the pan (the oil-inflatable shock absorber will slow down the speed of the tilt) until complete draining of the pan.

d) Pull the tank back, lock and dry.

e) Clean the sides and bottom with a sponge to eliminate all impurities.

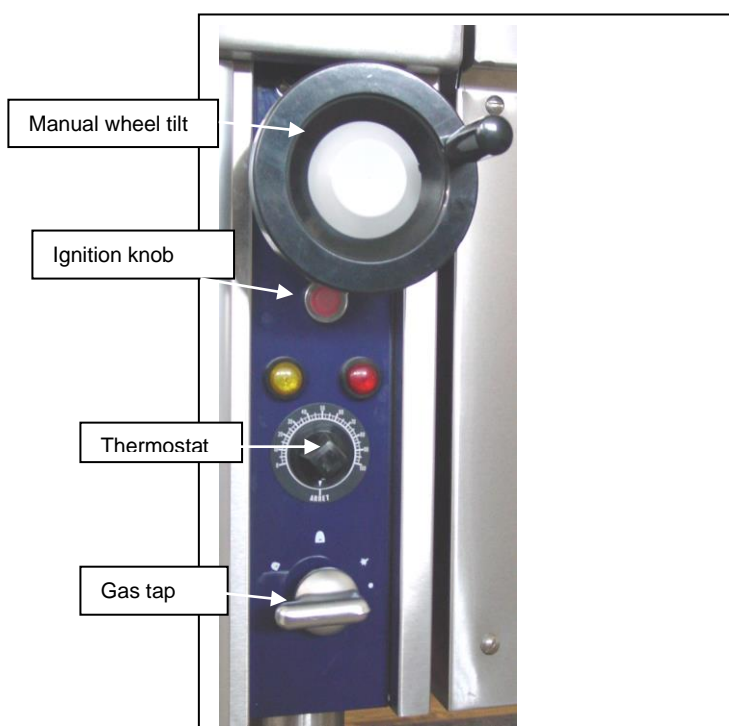

3. PRACTICAL ADVICE

Any kind of food can be cooked in the bratt pan (sautéed, grilled and braised meat, vegetables, rice, noodles...).

Grillings are preferably cooked on griddles or charcoal grills.

All dried and greased cooking are preferably cooked with a lid open and all wet and simmer cooking are preferably cooked with a lid closed.

NOTE: The device « Pan tilt safety cut out » will automatically cut the heat during the tilt of the pan.

Attention! There are major risks of burning your arm if you have it positioned above the pan when opening the lid.

When emptying the tank:

- **Stay far away from the tank when pouring out the food to the containers to avoid burns coming from the hot splashes.**
- **The control of the tilt will drive safely the food to the front spout.**
- **Pull back the tank when replacing the containers.**

GAS-FIRED TILTING BRATT PAN

4. SWITCHING OFF

Bring the control knobs back to the "λ" position.
Wait until the apparatus has cooled down before doing anything on it.
Clean the tank after each use and dry it.
At the end of the day, cut off gas supply or switch off electricity at the mains.

5. MAINTENANCE

5.1. Cleaning of the stainless steel surfaces

Wash with a sponge in soapy water (or any other neutral cleaning product).
Do not use bleach or any other acidic product – even well diluted.
For the tops, use a nylon scouring pad if necessary. Always go with the grain.
After each cleaning, rub with a greased cloth or kitchen paper.
Finger marks can be removed with a cloth dabbed with alcohol.

5.2. Cleaning of the tank

Wash with a sponge in soapy water (or any other neutral cleaning product).
Rinse thoroughly the tank after cooking salty food to avoid pittings.

5.3. Cleaning of the burner

Please call for a technician.

This apparatus must not be cleaned with water under pressure or too much water splashed onto the burners as this might obstruct the gas supply.

For the electric ignition option, ensure that it is switched off at the mains.

For best results, have your equipment serviced and cleaned on a regular basis by a qualified installer (for the list of spare parts, see attached installation and set-up instructions).

CAUTION: Factory-sealed components must be serviced by neither installer nor user.

6. POSSIBLE CAUSE OF BREAK DOWN

6.1. Unsatisfactory heating: probable causes

- . Clogging of the burners, injectors...
- . Incorrect gas pressure.
- . Incorrect grading of the injectors.
- . Clogging of the rear internal flue box.

6.2. Unsatisfactory ignition: probable causes

- . Clogging of the pilot light or of the thermocouple.
- . Difficult ignition of the thermocouple or pilot light flow: control knob are not positioned correctly or not pushed far enough.
- . Faulty electric ignitor.

Contact the supplier to replace faulty parts.



Only a qualified electrician should replace the ignition transformers.

The manufacturer and the fitter cannot be held responsible if the user neglects to ask for assistance in case of breakdown.



GAS-FIRED TILTING BRATT PAN

Transfer below information written on the data plate of your apparatus.
The data plate will ease the communication between you and your dealer for better service.

 **CHARVET S.A.**
38850 CHARAVINES

Réf.

Code: Type:

N°FC: Rep.

Cat.				
Gaz				
P (mbar)				
ΣQ_n (kW)				
ΣV_n (m ³ /h)				
ΣM_n (kg/h)				

U V Ip

f Hz P kW



MADE IN FRANCE

