



GMC 1600

2 & 4 INDUCTION COOKING ZONES

DESCRIPTION	EXTEND CONCEPT
GMC0071	Module 1600
GMC0152	



INSTALLER'S INSTRUCTIONS

CHARVET

F-38850 – CHARAVINES
Tel.: +33 4 76 06 64 22
Fax: +33 4 76 55 78 75
Email: info@charvet.fr
Email: sav@charvet-sa.fr



MANUAL: EN - GMC 1600 INDUCTION MULTI-ZONES
Ind. B – Created on: 12.03.2010
Updated on: 09.07.2010

SUMMARY

INSTALLER'S INSTRUCTIONS	1
1. INSTALLATION	3
1.1. GENERAL POINTS	3
1.2. HANDLING	3
1.3. INSTALLATION	3
1.4. DATA PLATE	4
2. POWER CONNECTION.....	4
2.1. ADJUSTING THE PLINTH (GMC APPLIANCE)	5
2.2. CHECKS BEFORE PROCEEDING.....	6
2.3. CONNECTING THE APPLIANCE	6
2.4. CHECKS AFTER CONNECTION	7
2.5. ADAPTING THE APPLIANCE TO THE VARIOUS ELECTRICAL SUPPLIES VOLTAGE	7
3. WIRING DIAGRAMS	8
4. BASIC SPARE PARTS LIST.....	12
5. MAINTENANCE.....	13
5.1. ELECTRIC OVEN: CHANGING THE HEATING ELEMENT.....	13
5.2. HOT CUPBOARD: CHANGING THE HEATING ELEMENT.....	13
5.3. CHANGING THE GENERATOR FOR DOUBLE HOBS MOUNTING AND MULTI-ZONE MOUNTING	14
6. BREAKDOWN	16

1. INSTALLATION

1.1. General points

Installation must be undertaken in compliance with the following instructions and with local codes and bylaws. Ensure you have a suitable and sufficient risk assessment in place.

The user manual must be given to the user after installation.

1.2. Handling

It is imperative to leave the appliance on its wooden pallet for handling on site until the final installation.

Unpack and check the appliance for damage upon receipt.

In case of damage, mark delivery note accordingly and immediately (within 48 hours) notify the carrier by registered mail with acknowledgement of receipt. Notify your installer.

1.3. Installation

All local fire regulations must be adhered to.

The appliance must be installed under a suitable mechanical extraction hood, close to the electric supply.

If the apparatus is to be installed against a wall or partition, near a piece of furniture or decorative borders, it is recommended that these are made of fireproof material.

If this is not the case, they must be protected by an approved fireproof, insulating material.

If in doubt of fireproof construction of adjacent walls, distance to combustible material shall be no less than 10 cm.

Remove all plastic protection.

Install the appliance in the kitchen.

Warnings



Fixed appliance:

- Check that the masonry plinth is well horizontally leveled.
- Adjust height to level the unit to a horizontal working plan of 900 mm.

**Any technical action on an appliance must be undertaken by a qualified technician.
The appliance will have to be isolated from the electrical supply for the duration of the work.**



When the appliance is ready for use, ensure the users know how to use it properly.
(Please see the user's manual).

Warranty: The warranty is mentioned in our conditions of sale.

This warranty does not cover damage due to faulty installation, misuse or inadequate maintenance.

1.4. **Data plate**

Each appliance has its own data plate. Transfer all this information on the last page of the user's manual. **This will ease the communication between you and your client for better service.**

	
<p style="text-align: center;">Data plate Inside cupboard / hot cupboard</p>	<p style="text-align: center;">Inside open base</p>

2. POWER CONNECTION

Warnings:



The appliance must be earth wired.
It is dangerous to connect the appliance unless it is earthed.
We cannot be held responsible for accidents due to non-existent or incorrect earth link connection.

Fixed appliance:

Check that the electric network is equipped with all-pole circuit breakers having a cross section of 3.5 mm at least. All electrical equipment must be in compliance with the standard EN 60335-1.

WARNING:

Use a standardized cable (245 IEC 57 or 245 IEC 66) or other approved cable with the same characteristics.

All controls and checks below are done when the appliance is switched off and cold.

2.1. **Adjusting the plinth (GMC appliance)**

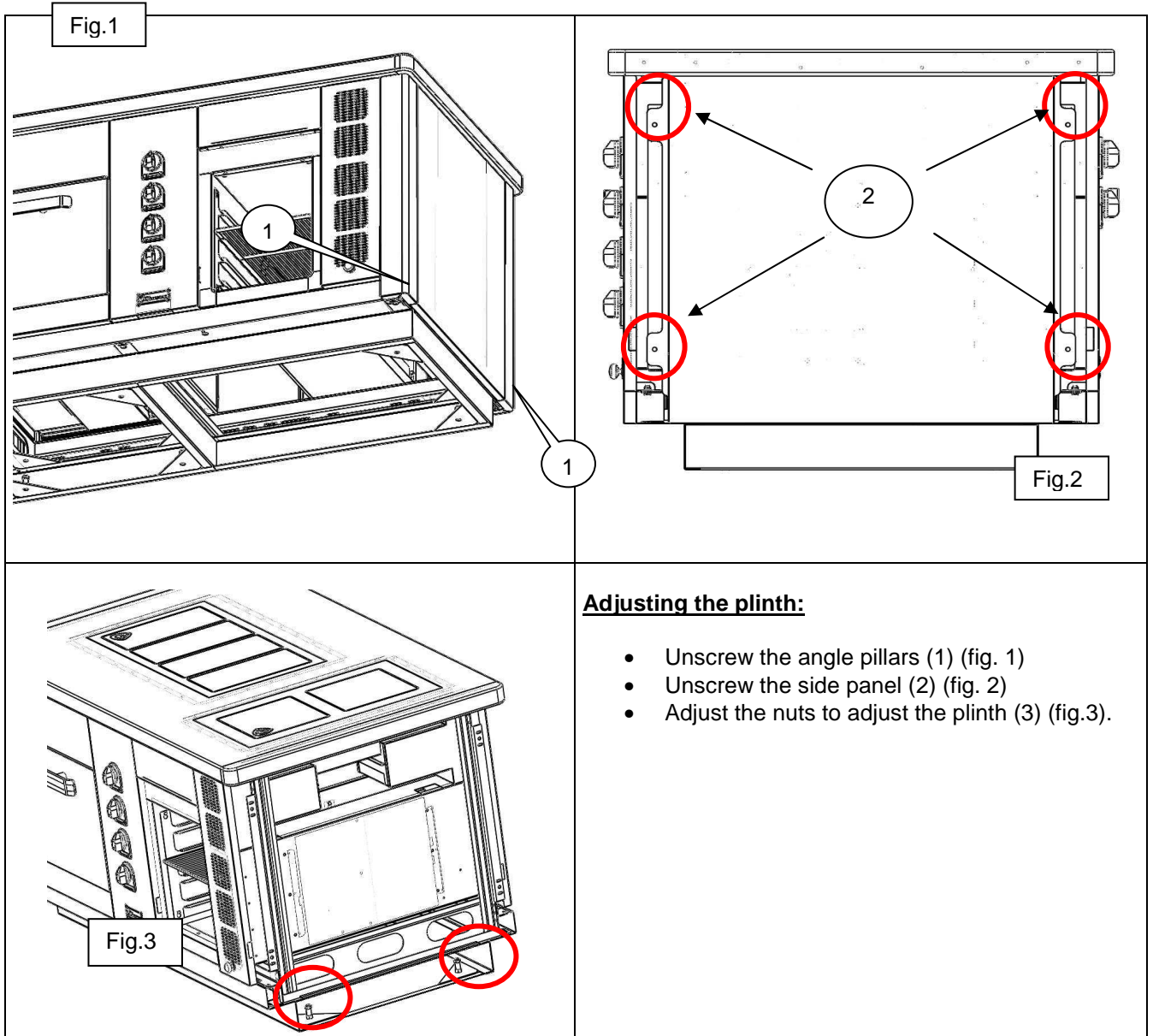

2.2. **Checks before proceeding**

Check that:

- The electrical voltage of the supply is compatible with the voltage of the apparatus (see data plate and § 2.5).
- The cable is fixed properly,
- The connections are tight enough,
- The section of the cable is of correct size according to the voltage of the apparatus.

2.3. **Connecting the appliance**

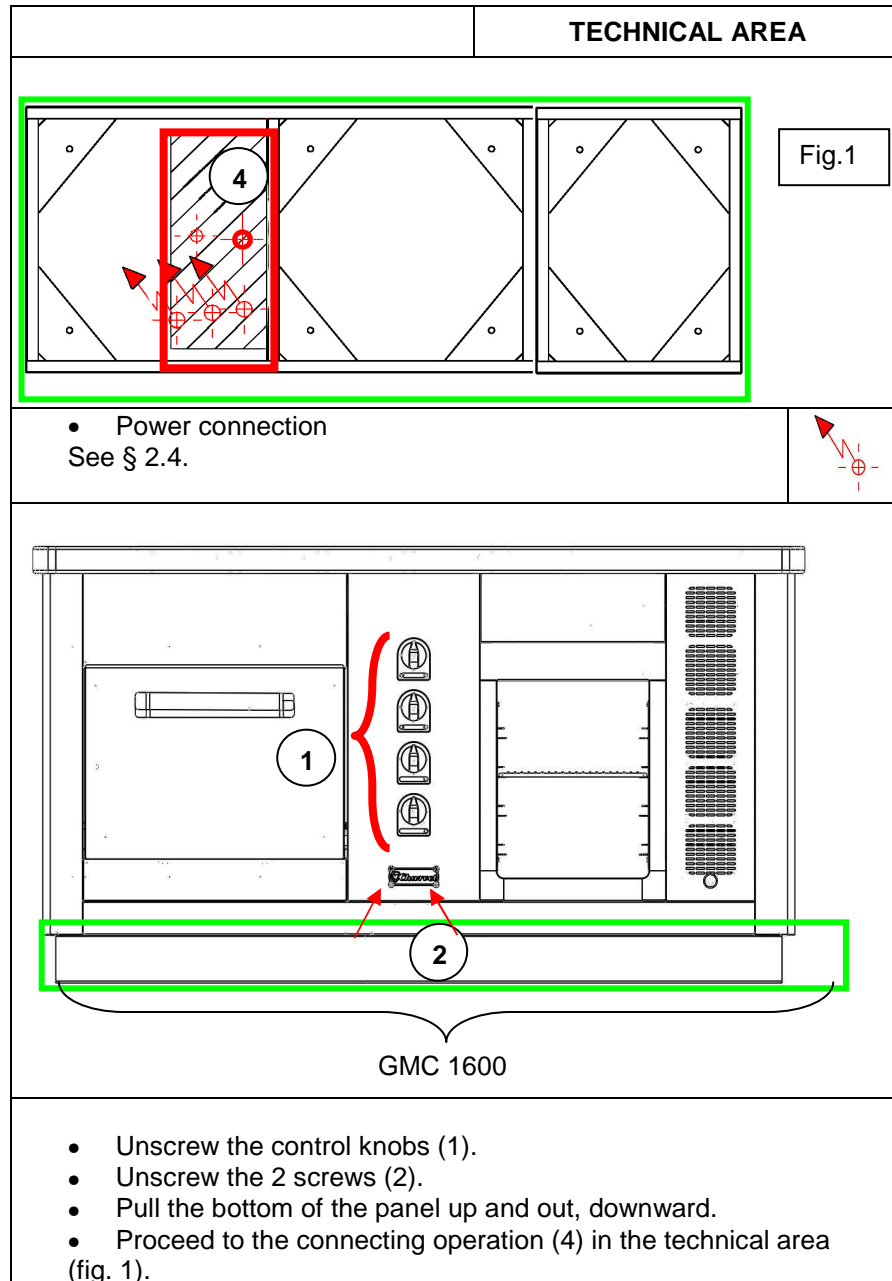

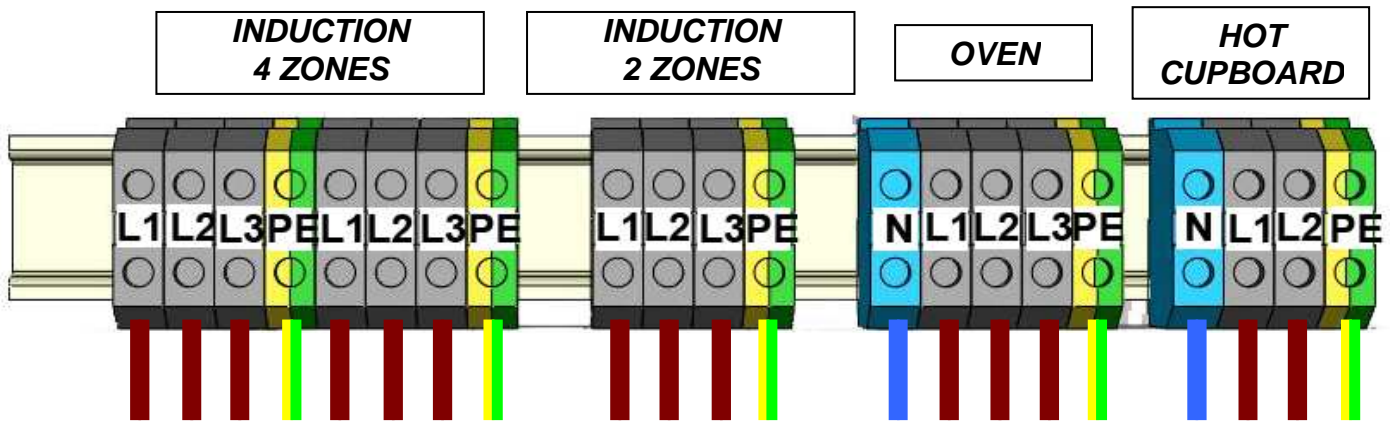

2.4. Checks after connection

- The appliance is earth wired (see the warnings).
 - The equipment is well isolated
 - The appliance is in good working conditions.
- STARTING UP: Please see the User’s Manual, section “Starting up”

2.5. Adapting the appliance to the various electrical supplies voltage

Voltage	⇨			
Various voltages	⇩	1~230V + E	3~230V + E	3~400V + E
	Wiring diagrams #	S = standard coupling		
Hot cupboard	TR0038	S	A	A
Electric oven	TR0101	S	A	A
Two induction hobs	TR0116	S	A	A
Multi-zone induction cooktop	TR0122	S	A	A
A → Coupling possible B → Please consult Charvet C → Coupling impossible D → No voltage available				

3. WIRING DIAGRAMS

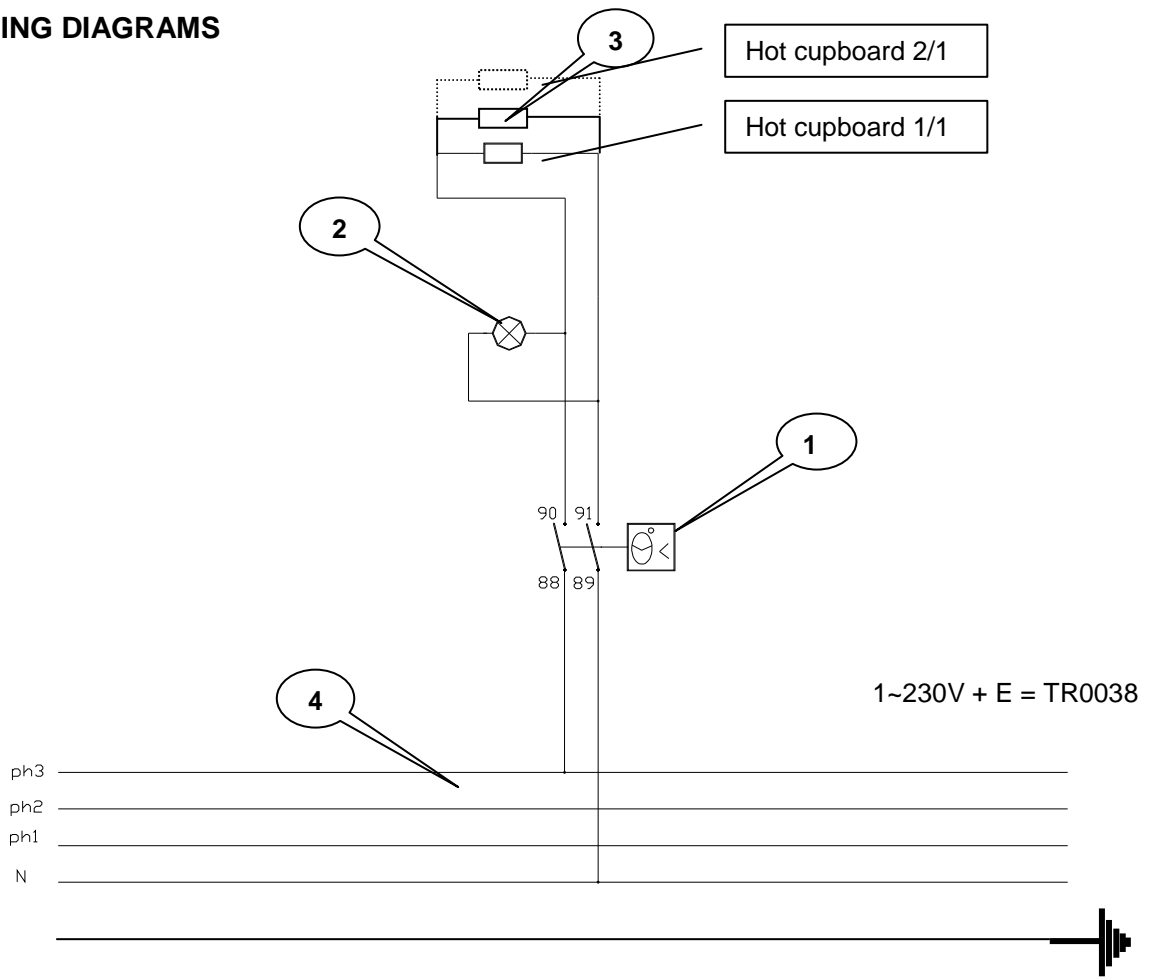

Nomenclature: Hot cupboard – single phase 230 V

Marks	Code	Description	Quantity
01	ELE0304	Regulation thermostat	1
02	ELE0434	230V heating indicator	1
03	ELE0231	Heating element 230V 600W	2
04	02466A	Terminal	3
04	03575A	Earth terminal	1

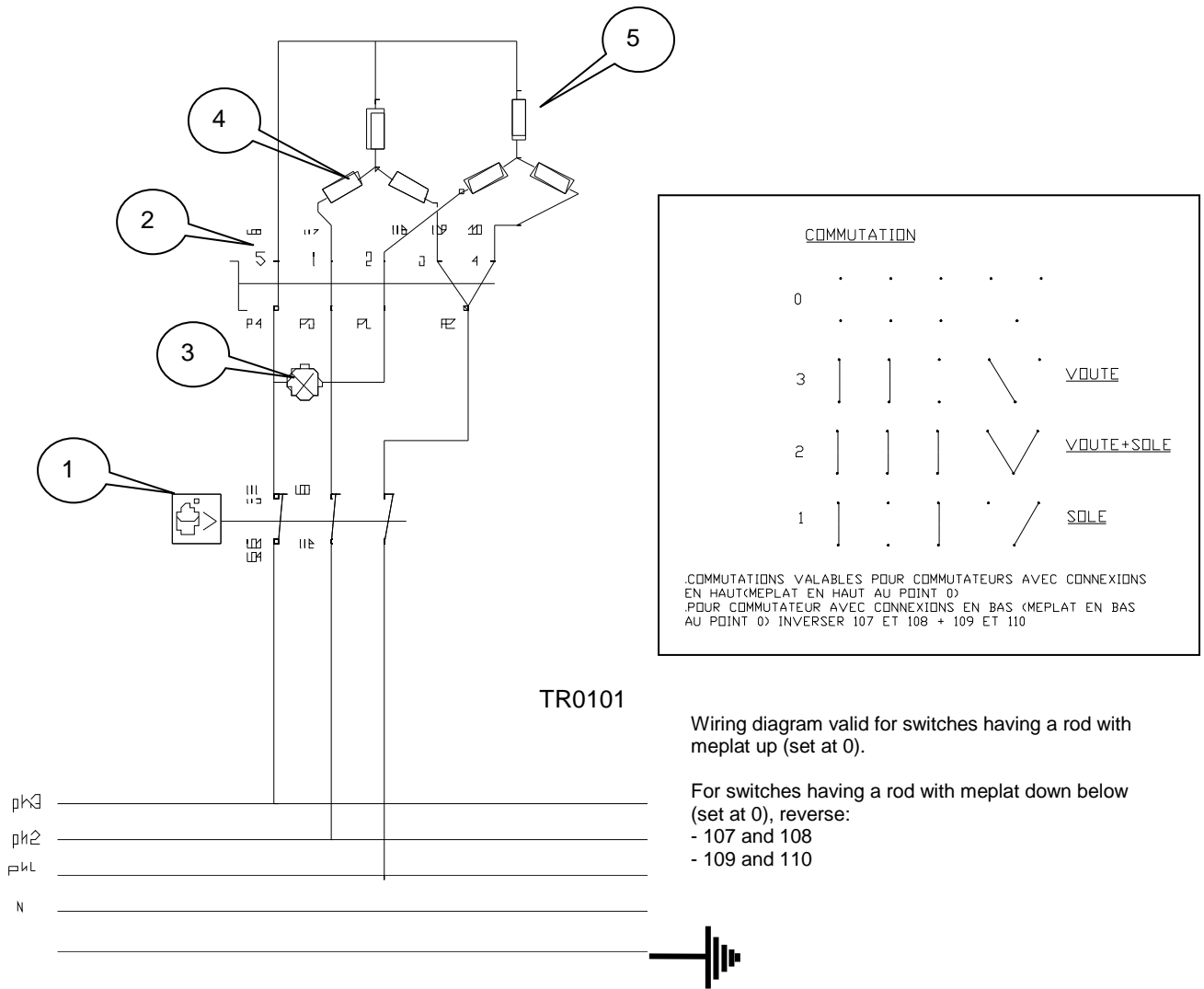

Wiring diagram valid for switches having a rod with meplat up (set at 0).

For switches having a rod with meplat down below (set at 0), reverse:
 - 107 and 108
 - 109 and 110

Nomenclature: Electric pass-through oven

Marks	Code	Description	Quantity
01	08426A	Thermostat 350°C	1
02	Ele0074	4-position switch	1
03	Ele0435	400V heating indicator	1
04	502632	Vault heating element 1200W	3
05	502637	Mild steel base heating element 1800W	3

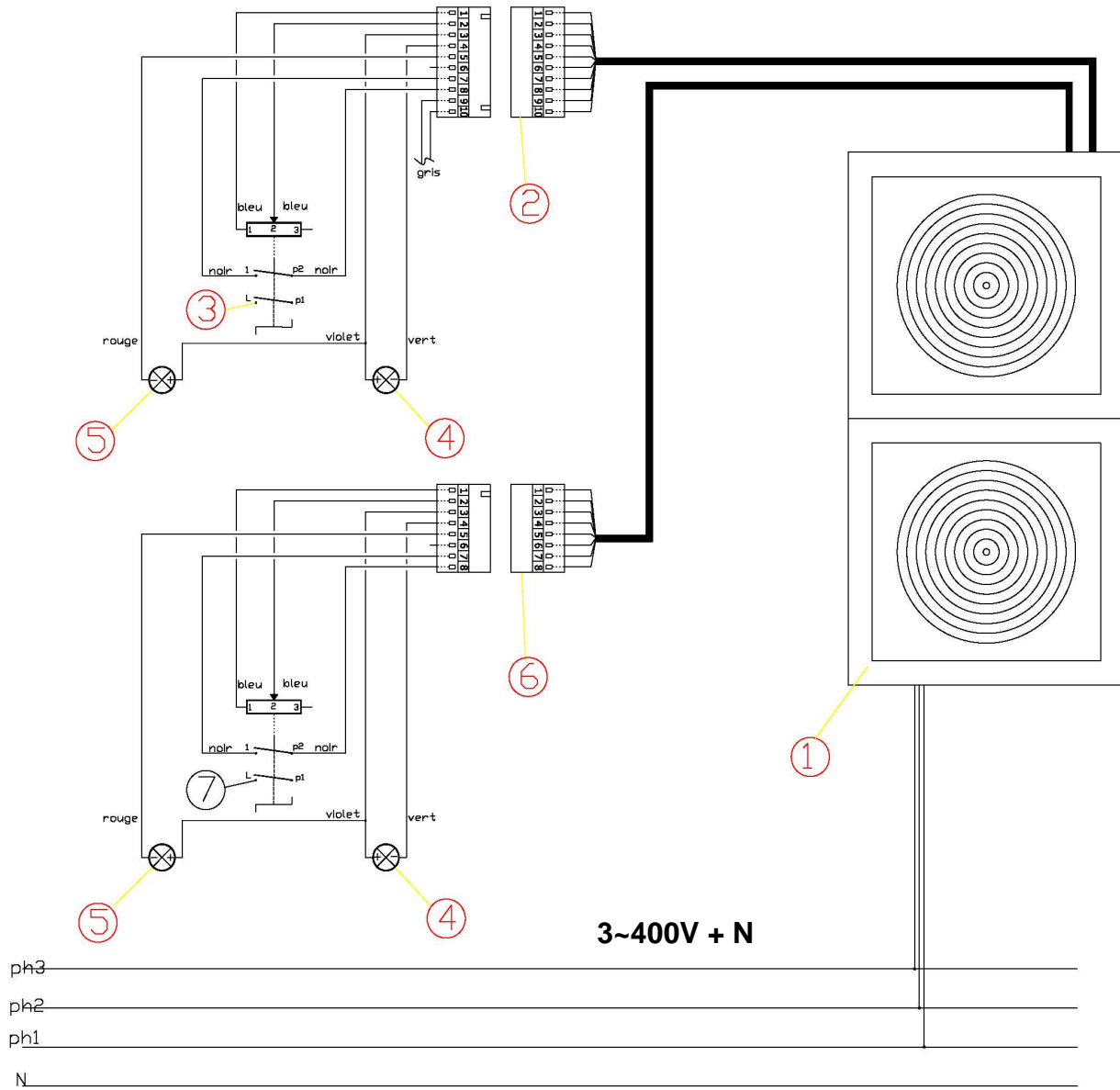

Nomenclature: Two induction hobs TR0116



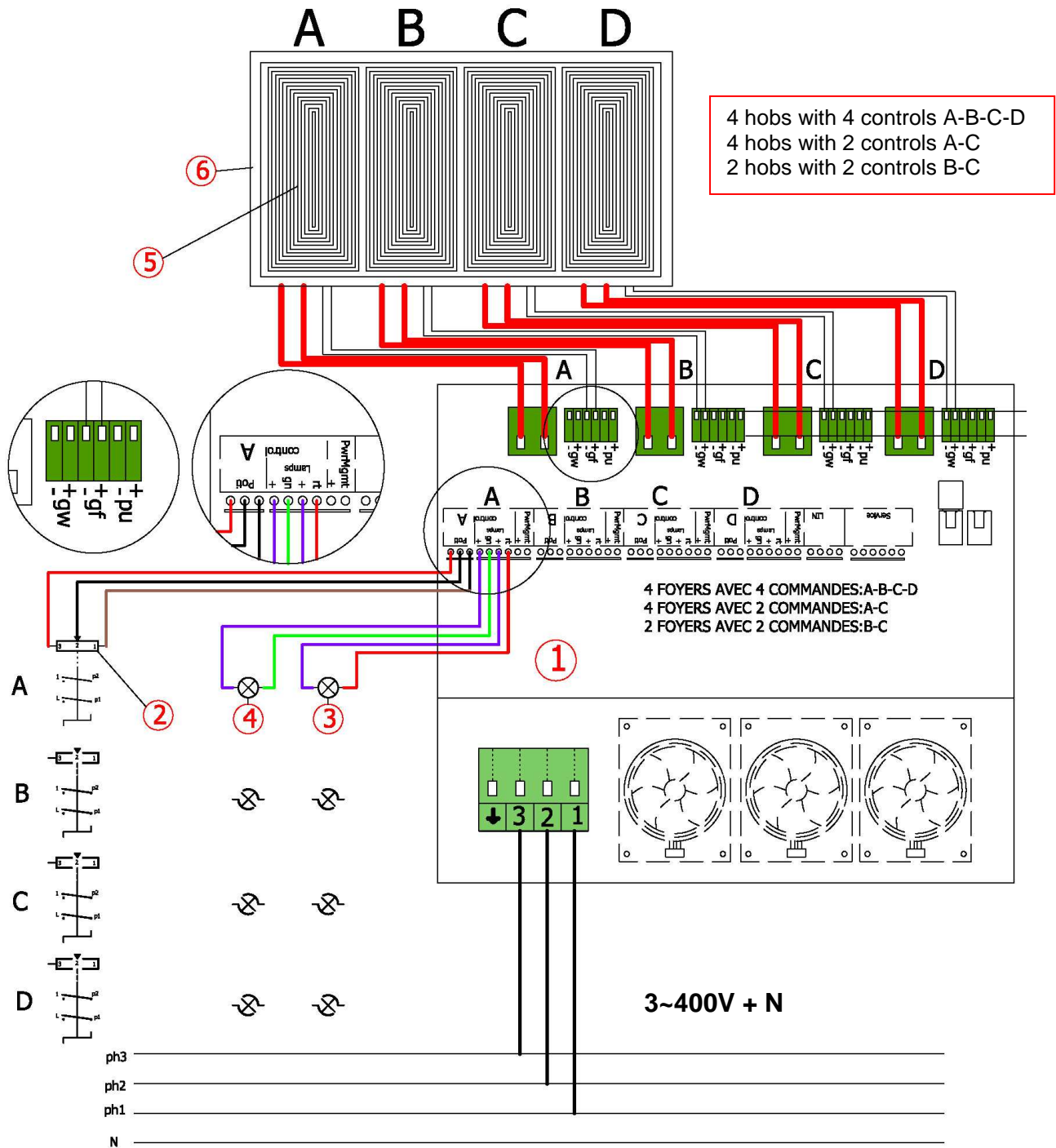





Marks	Code	Description	Quantity
01	503367	Generator 2x5 kW	1
02	07083A	10-point connector	1
03		Switch + Potentiometer	1
04	ELE0322	ON green indicator 24 V	2
05	ELE0321	Error red indicator 24 V	2
06	07082A	8-point connector	1
07		Switch + Potentiometer	1

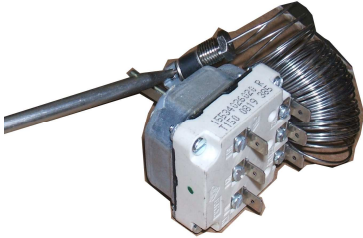
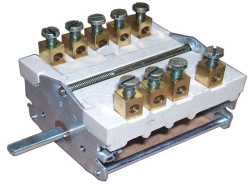
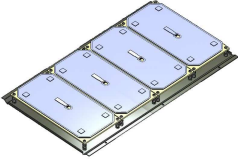
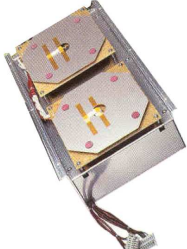

Nomenclature: Multizone induction cooktop TR0122

Marks	Code	Description	Quantity
01	503372	Generator for the set: 4 x 3.5 kW	1
02	501424	Control knob	1
03	50412	ON green indicator 12 V	1
04	50413	Error red indicator 12 V	1
05	503373	Inductor 4 x 3.5 kW	1
06	504341	Glass-ceramic cooktop 420 x 810 mm	1

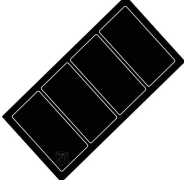
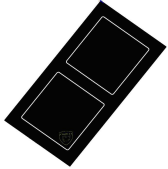
4. BASIC SPARE PARTS LIST

Description / Code	Photograph	Description / Code	Photograph
Orange indicator Ele0434 Red indicator Ele0435		Thermostat Ele0308	
Heating element 230 V		Electric oven heating element Vault 1200 W 502632 Mild steel base 1800 W 502637	
Hot cupboard thermostat ELE0304		Oven switch Ele0074	
	Multi-zone induction cooktop		Two induction hobs
Inductor 503373		Generator 2x5 kW 503367	
Control knob 501424		Control knob 10 pins 07083A 8 pins 07082A	
Ceramic hobs Multi-zone induction cooktop Div0630		Ceramic hobs Two induction hobs 501425	
Generator 4 x 3.5 kW 503372			

5. MAINTENANCE

5.1. Electric oven: changing the heating element

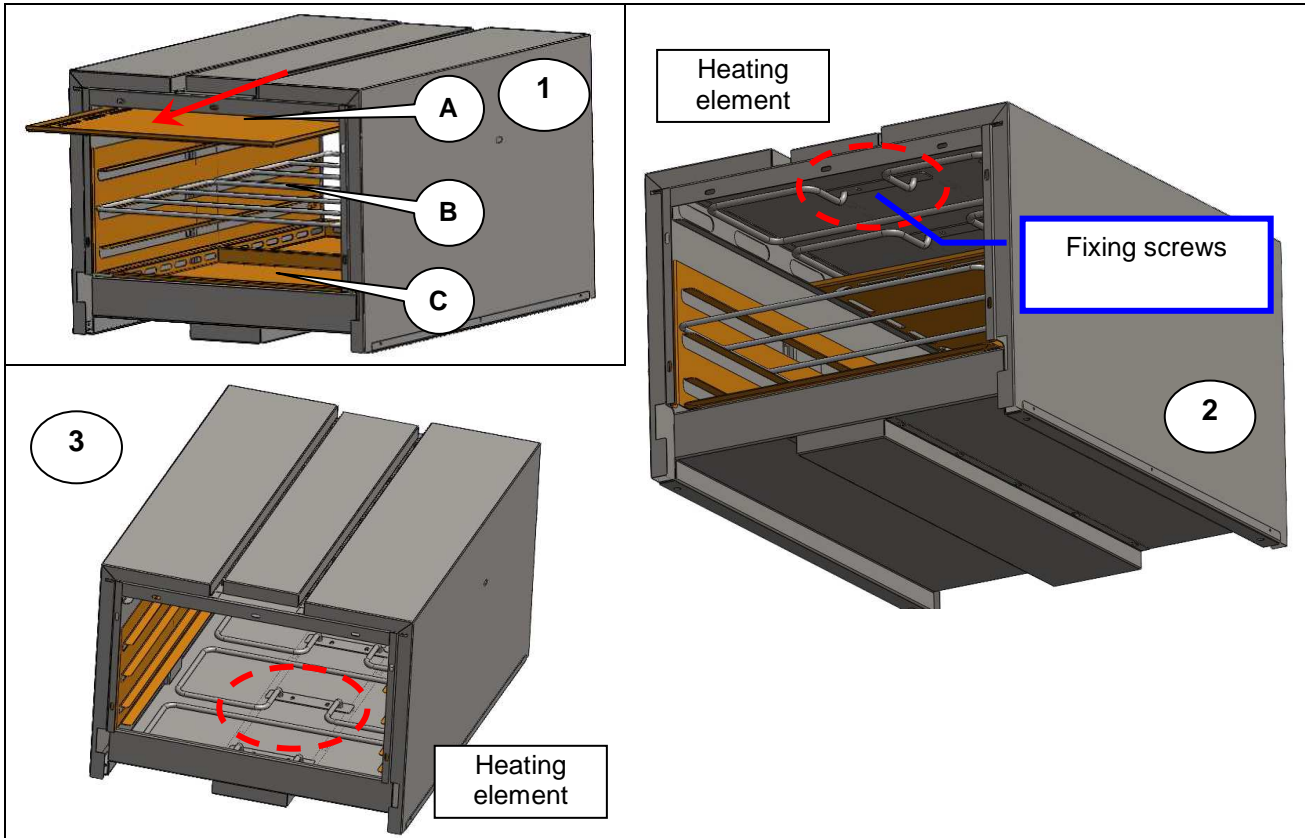

Removing the heating element:

Open the oven door. Remove the enameled vaults from the oven. (A) Remove the grids (B) then the mild steel bases (C). Unscrew the fixing screws (2) and (3).

5.2. Hot cupboard: changing the heating element

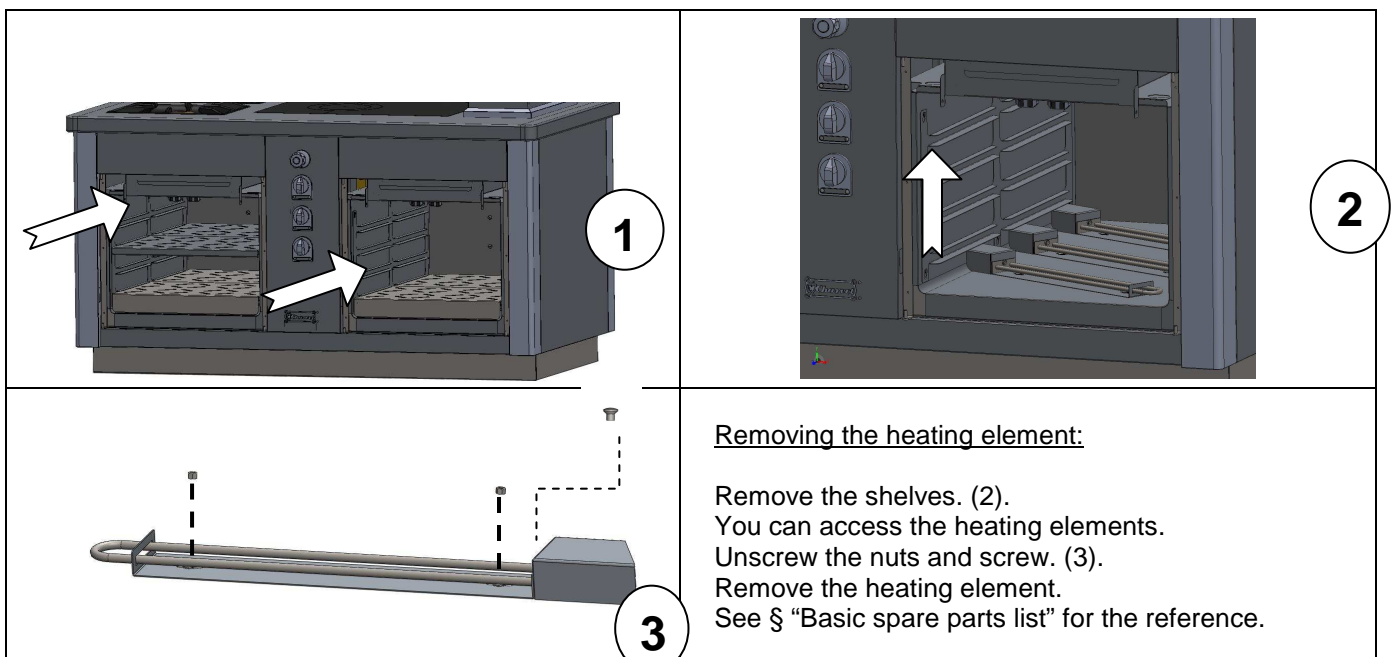

Removing the heating element:

Remove the shelves. (2). You can access the heating elements. Unscrew the nuts and screw. (3). Remove the heating element. See § "Basic spare parts list" for the reference.

5.3. Changing the generator for double hobs mounting and multi-zone mounting

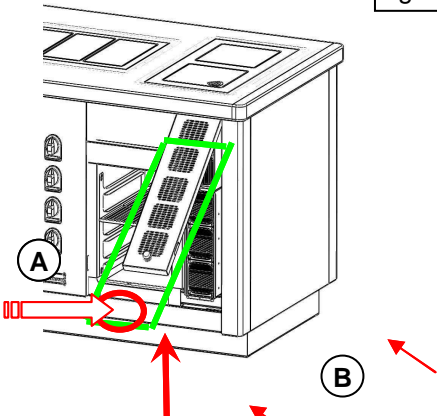
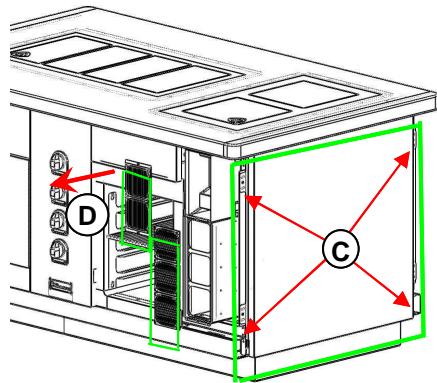
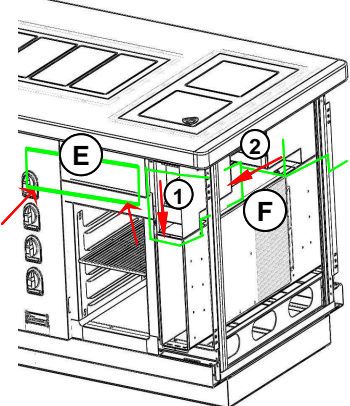
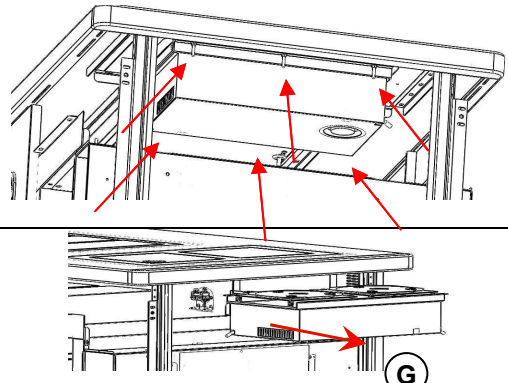
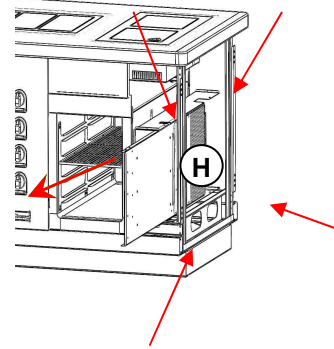
 <p>Fig.1</p>	 <p>Fig.2</p>
 <p>Fig.3</p>	<p>Generator for double hobs</p>  <p>Fig.4</p>
<p>1) Unscrew the front panel (A) (fig.1). Pull it. Lift it. Unscrew the angle pillars (B) to remove them (Fig. 2). 2) Unscrew the front panel (C). Remove the filters. (D). 3) Unscrew the top panel (E) and the air exhaust coffer (F).</p> <p><u>Generator for double hobs</u></p> <p>4) Unscrew the generator (6 screws) and disconnect the connectors. (fig.4). 5) Remove the generator (G).</p> <p><u>Generator for the set: 4 x 3.5 kW</u></p> <p>6) Unscrew the generator (4 screws), then slide the panel of the coffer (H).</p>	<p>Generator for the set: 4 x 3.5 kW</p> <p>Fig.5</p> 

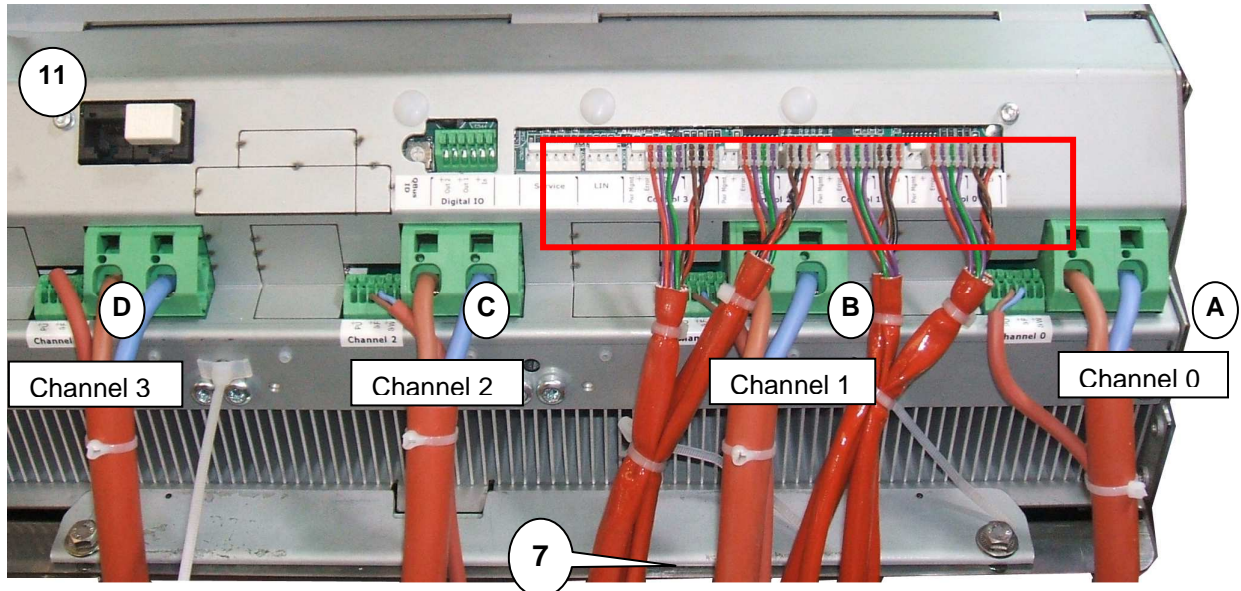

Marks	Description
1&2	Connection of the options (+Pu)
3&4	Connection of the flat safety probe (+gf)
5&6	Connection of the wok safety probe (+gw)
7	Control knob
8	Inductor coil (power) connected to the inductor
9	Control section: 4-pin connector for indicators
10	Control section: 3-pin connector for control potentiometer (poti)
11	Generator for the multi-zone induction cooktop
12	Terminal block (electric supply)

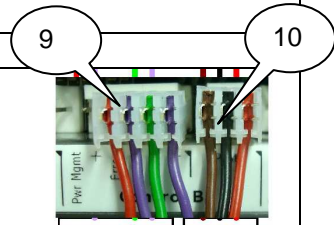

Connection of the inductor and temperature sensor	
A	Channel 0 – inductor #1
B	Channel 1 – inductor #2
C	Channel 2 – inductor #3
D	Channel 3 – inductor #4

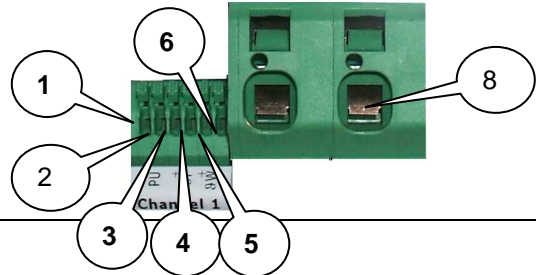

! : WARNING: To connect the 3-pin and 4-pin connectors, follow carefully the indications written on labels 9 and 10.

Connecting the control elements:

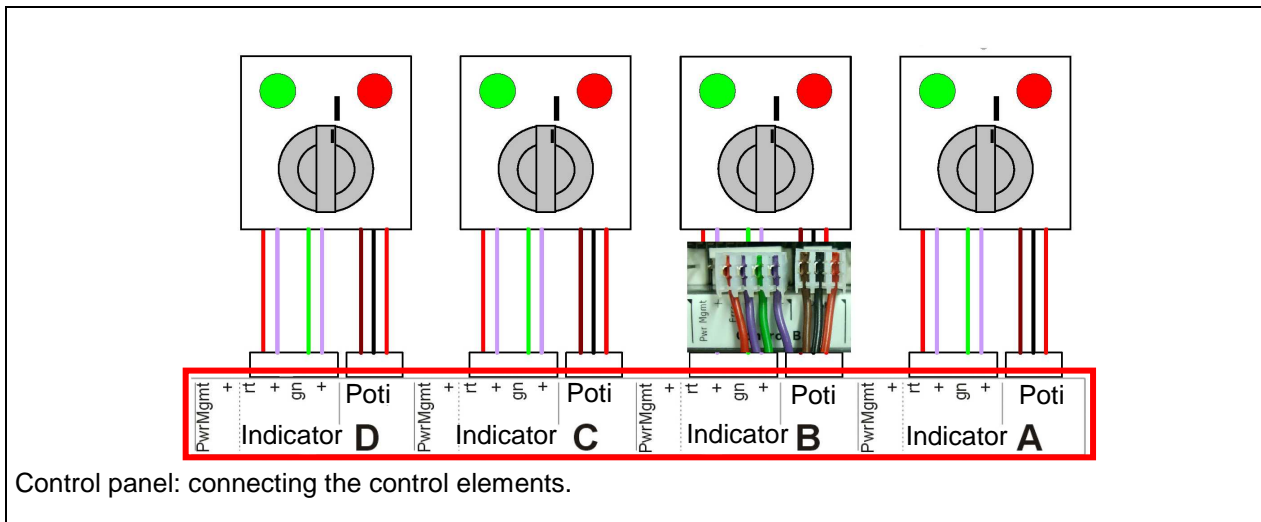

Control panel: connecting the control elements.

Error Messages and Troubleshooting



6. BREAKDOWN

Breakdown detected by the generator are indicated by the red and green indicators. The green indicator is dedicated to a certain type of breakdown depending on a predetermined cycle: A long ignition + code (= quantity of flashings between the long ignition cycles).

*Code: Quantity of flashings (1xlong+code)

Code*	Breakdown	Cause	Corrective action
1	Hardware current intensity	Unsuitable pan material OR faulty inductor	Use suitable pan material OR check inductor
2	No inductor current	Inductor not connected No electric supply	Connect inductor
3	Radiator temperature too high	Air routes blocked Fan clogged. Faulty inductor temperature probe	Clear air routes Clean fan, and replace probe
4	Cooking area temperature too high or too low	Pan is empty	Remove pan and switch off. Wait until it has cooled down before replacing the temperature sensor
5	Open circuit at control knob	Control knob defective	Check/replace control knob
6	Internal temperature too high or too low	Air routes blocked Fan clogged or faulty inductor temperature probe	Clear air routes Clean fan / replace sensor
7	Cooking area temperature probe	Inductor temperature probe short-circuited	Check and replace probe
8	Phase error	Phase defective	Check phases
10	Communication error	LINBUS or CANBUS No connection between keyboard and generator	Disconnect from mains and check connection
11	Initialization error	Hardware initialization error	Wait for automatic updating (every 30 seconds about)
12	Power supply error	Current measurement error	Check connection to the main supply
13	Connection error to the main supply	Too high or too low voltage	Check connection to the main supply
14	Power supply error	Too high or too low voltage	Check connection to the main supply
15	Safety device	Empty pan or faulty probe	Remove the pan. Switch off and wait until cooking area has cooled down. Replace sensor if needed. Disconnect appliance, wait for a few minutes, and connect appliance again



GMC 1600

2 & 4 INDUCTION COOKING ZONES

DESCRIPTION	EXTEND CONCEPT
GMC0071	Module 1600
GMC0152	



Use Manual

CHARVET

F-38850 – CHARAVINES
Tel.: +33 4 76 06 64 22
Fax: +33 4 76 55 78 75
Email: info@charvet.fr
Email: sav@charvet-sa.fr



MANUAL: EN - GMC 1600 INDUCTION MULTI-ZONES
Ind. B – Created on: 12.03.2010
Updated on: 09.07.2010

SUMMARY

USE MANUAL	1
1. INTRODUCTION	3
2. PRIOR TO STARTING UP	3
2.1. MULTI-ZONE AND DOUBLE INDUCTION COOKTOP	3
2.2. ELECTRIC OVEN.....	4
2.3. ELECTRIC HOT CUPBOARD	4
3. STARTING UP	5
3.1. MULTI-ZONE INDUCTION COOKTOP.....	5
4. SWITCHING OFF	6
5. MAINTENANCE	7
5.1. CLEANING OF THE STAINLESS STEEL SURFACES.....	7
5.2. CLEANING THE OVEN	7
5.3. CLEANING THE CERAMIC HOBS	8
5.4. CLEANING THE AIR FILTER.....	8
5.5. MAINTENANCE: MILD STEEL BASE, OVEN SHELF, SHELF RUNNERS, ELECTRIC OVEN AND HOT CUPBOARD	9
6. BREAKDOWN	10

1. INTRODUCTION

- A) Our equipment is for professional use only and must be used by qualified staff.
- B) The equipment must be installed in compliance with local codes and bylaws. It must be installed in a kitchen equipped with an adequately sized mechanical extraction system.
- C) Appliances may be installed side by side or against walls of non combustible material. Distance to combustible material shall be no less than 10 cm.
- D) It is imperative to call for a qualified engineer for all new installations or modifications of existing equipment.
- E) **WARRANTY:** *The warranty is mentioned in our conditions of sale. Only a qualified engineer certifies the validity of the warranty. This warranty does not cover damage due to faulty installation, misuse or inadequate maintenance.*

Warning

PEOPLE WITH CARDIAC PACEMAKER OR METAL IMPLANT CANNOT USE THIS KIND OF APPLIANCE. PLEASE INFORM THESE PEOPLE OF THE RISKS. THESE PEOPLE MUST CONSULT A PHYSICIAN OR THE MANUFACTURER OF THE CARDIAC PACEMAKER AND METAL IMPLANT.

PEOPLE WITH CARDIAC PACEMAKER CANNOT USE THIS KIND OF APPLIANCE

**NEVER LEAVE AN EMPTY PAN ON AN INDUCTION COOKTOP.
EMPTY PAN WILL CAUSE THE GENERATOR TO SHUTDOWN.
(THE RED INDICATOR WILL BE ALIGHT)**

2. PRIOR TO STARTING UP

- a) Prior to starting up, it is advisable to clean the appliance in order to eliminate all dust and impurities that have accumulated during storage.
- b) Remove all plastic protection that wraps the stainless steel panels.
- c) Make sure that all controls are in good working condition.

We recommend ovens are run empty for 1 hour to avoid an unpleasant taste of new material in food.

2.1. Multi-zone and double induction cooktop

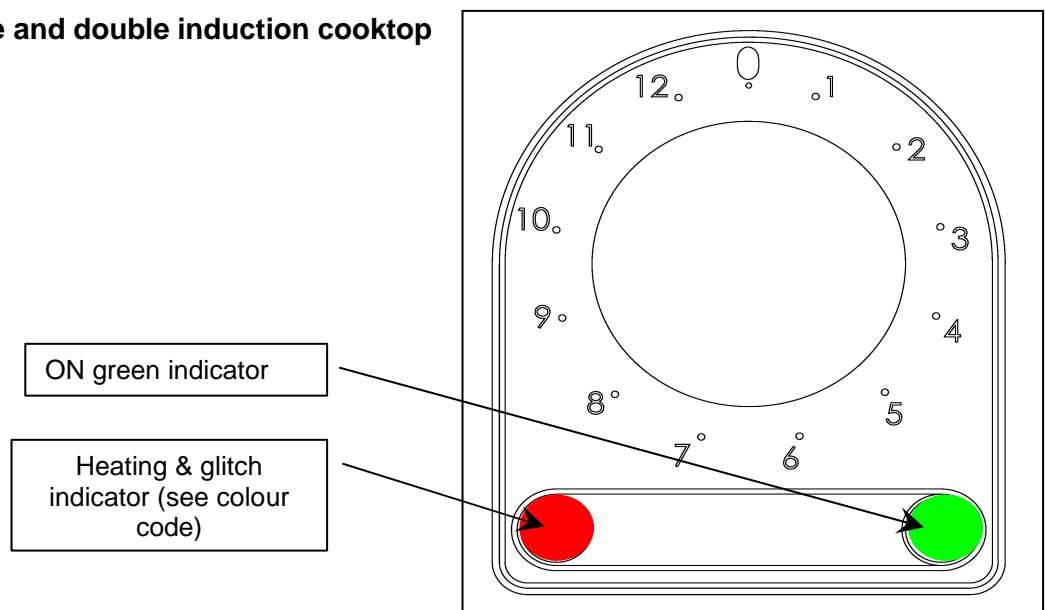

2.2. **Electric oven**

- Turn control knob to the desired position (vault / vault-mild steel base / mild steel base); the heating indicator is alight.
- Turn thermostat to the desired temperature; the heating indicator is illuminated.
- When the desired temperature is reached, the regulation indicator is darkened. The regulation thermostat will constantly adjust the temperature of the oven.

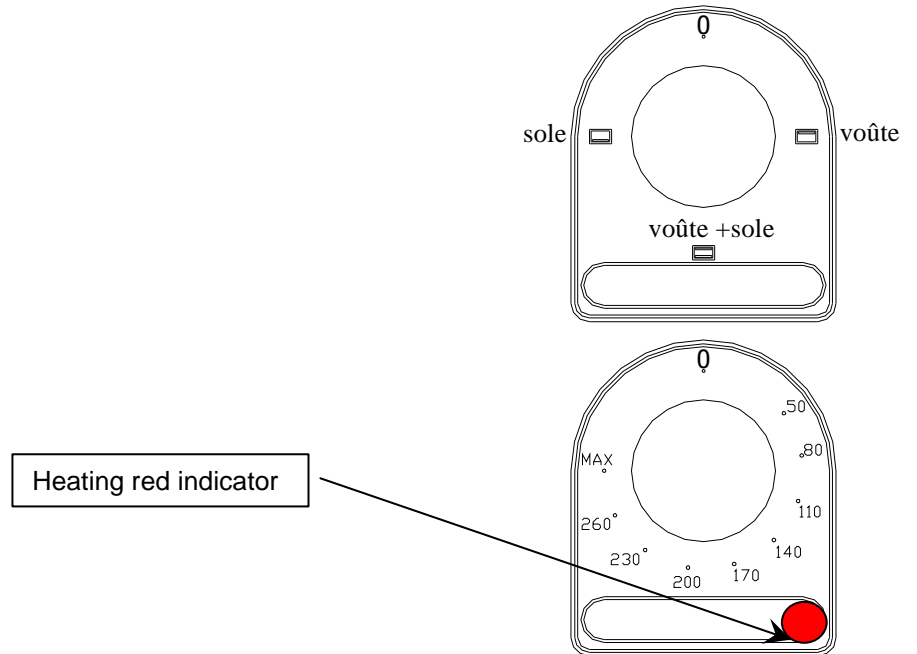

WARNING:

When opening the oven door in “wet” cooking mode, stay clear from the oven as vapours can escape and burn your skin very seriously!

Side panels and oven door may be extremely hot after a prolonged or intensive use. Be careful to open the door only with the handle.

2.3. **Electric hot cupboard**

The appliance is ON.



Turn the regulation thermostat knob to the desired temperature.

The orange indicator remains illuminated until the desired temperature is reached



3. STARTING UP

3.1. Multi-zone induction cooktop

<u>Testing the functions</u>	The generator must be connected. Pour the pans with water. ➔ See also "Handlings"
Operations to carry out for each inductor:	
<u>Warning indicators</u>	The green indicator (ON indicator) flashes when there is no pan. -----
For control knob only	The red indicator (error indicator) lights up when a dysfunction is detected. _____
<u>Fan</u>	<ol style="list-style-type: none"> 1) Place pans on all the cooking surfaces 2) Switch ON at full power 3) The fan should start up after a few minutes.
Operations to carry out for each inductor:	The pan is heating + displays are visible
<u>Pan detection</u>	 1) Place the pan (Ø12cm at a minimum) (green indicator)
The inductor should remain unlit in absence of pan(s)!	 2) Remove the pan(s): flash
Handlings:	Never heat empty pan(s) without supervision. Always centre pan(s) on the inductor(s).

Handlings:

Control knob

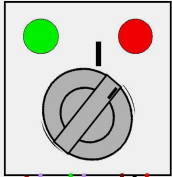
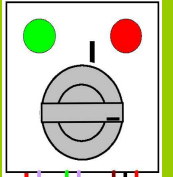
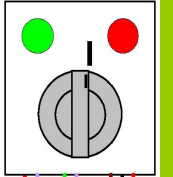

Inductor is ON (green indicator)
 Inductor is ON, no pan(s) (green indicator)
 Error (green indicator) 1 x long + code
 Error (red indicator)

ON	+/-	OFF
Turn control knob to the desired position	Turn control knob to the desired position	Turn control knob to the OFF position
		

Error indicator

Each cooking area has its own error indicator which indicates any eventual failure. In case of failure, the cooking area has no power anymore, the green indicator is unlit while the red indicator is alight (see section “Error Messages”).

PRACTICAL ADVICE

The induction appliance allows you to cook all kind of foods.

Before starting to cook, make sure you have pans (flat-bottom pans/pots) suitable for induction appliances.

Changing the cooking temperature will rapidly change the temperature of the pans. For roasting operations, start with empty frying pans or saucepans; they will heat up very rapidly.

If pans should be filled with oil or grease, they must be under constant supervision to avoid any overheating.

Make sure that saucepans are suitable for induction appliance, and of good quality.

- ☞ The detection diameter is of 12 cm.
- ☞ Do not leave small metal objects close to the cooking area as they might become hot.
- ☞ The user(s) should not wear any jewellery or a watch whilst working.
- ☞ Do not leave aluminium foil on the cooking area. It can melt and damage ceramic hob.
- ☞ Cut the power if the saucepan is withdrawn from the cooking area for a long period.

Several Pans

A **physical phenomenon** needs you to be cautious when positioning several pans on the same cooking area:

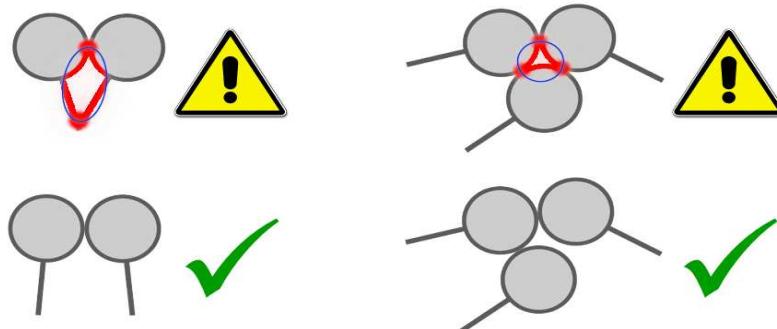

Note: Make sure saucepans do not touch each other. They could weld between themselves.

4. SWITCHING OFF

Turn control knobs to the “STOP” position = 0

When work is over for the day, cut power off at the mains.

5. MAINTENANCE

Before doing anything on the appliance, wait until cooking areas have cooled down.

5.1. Cleaning of the stainless steel surfaces

- a) Turn off the apparatus. After each service and before each cleaning operation, we advise you to disconnect the appliances from the mains.
- b) Wash with a sponge in soapy water (or any other neutral cleaning product).

Do not use bleach or any other acidic product – even well diluted.

5.2. Cleaning the oven

To avoid fumes due to greases, stains and food particles, we recommend you to clean all the oven internal sides every day.

The mild steel base can be removed to be cleaned. (See § 5.5).

The shelf runners can also be removed to be cleaned. (See § 5.5).

Wash the oven with a sponge in soapy water (or any other neutral cleaning product).

After cleaning, rinse and dry carefully all the parts.

Refit in order all the parts.

This appliance must not be cleaned with mechanical water jets or be subject to a deluge of water under pressure. Check that the appliance is well disconnected at the mains.

For information:

<i>Description</i>	<i>Weight of part (kg)</i>
<i>Enamelled mild steel base</i>	3 kg
<i>Enamelled vault</i>	2.5 kg
<i>Oven grid</i>	1 kg
<i>Shelf runner</i>	1.2 kg
*Note: For your safety, handle with care these parts.	

Cleaning the glass-ceramic cooktop

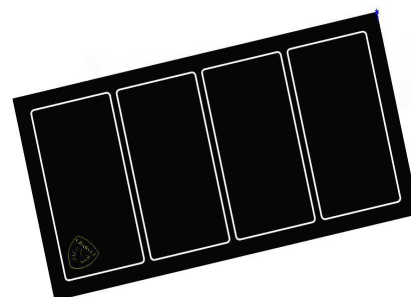
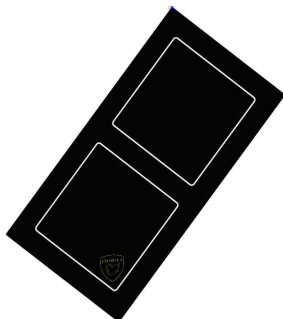

5.3. Cleaning the ceramic hobs

Wait until the apparatus has cooled down before doing anything on it (otherwise, there is a risk of burns). The ceramic hobs must be cleaned on a regular basis when it is warm or cold.

Slight stains:

Slight stains can be removed with slightly wet household roll towel.

Stubborn stains:

Stubborn stain can be removed with a cleaning product that does not cause any chemical reaction to the ceramic hobs.

(We recommend you to use cleaning products that suit the ceramic hobs).

Unsuitable cleaning products:

Using unsuitable cleaning products will cause damage to its surface. Never use scratchy or corrosive detergents such as spray cans for grills and ovens, solvents, cleaning powders and scratchy sponges.

While cleaning, check the good state of the seal between the top of the chassis and the ceramic hobs. If the seal is crackled or fragmented, the appliance must be immediately put out of order, and disconnected from the supply mains. Call your installer afterwards.

5.4. Cleaning the air filter

The air filter must be cleaned once a week to guarantee a good cooling of the generator.

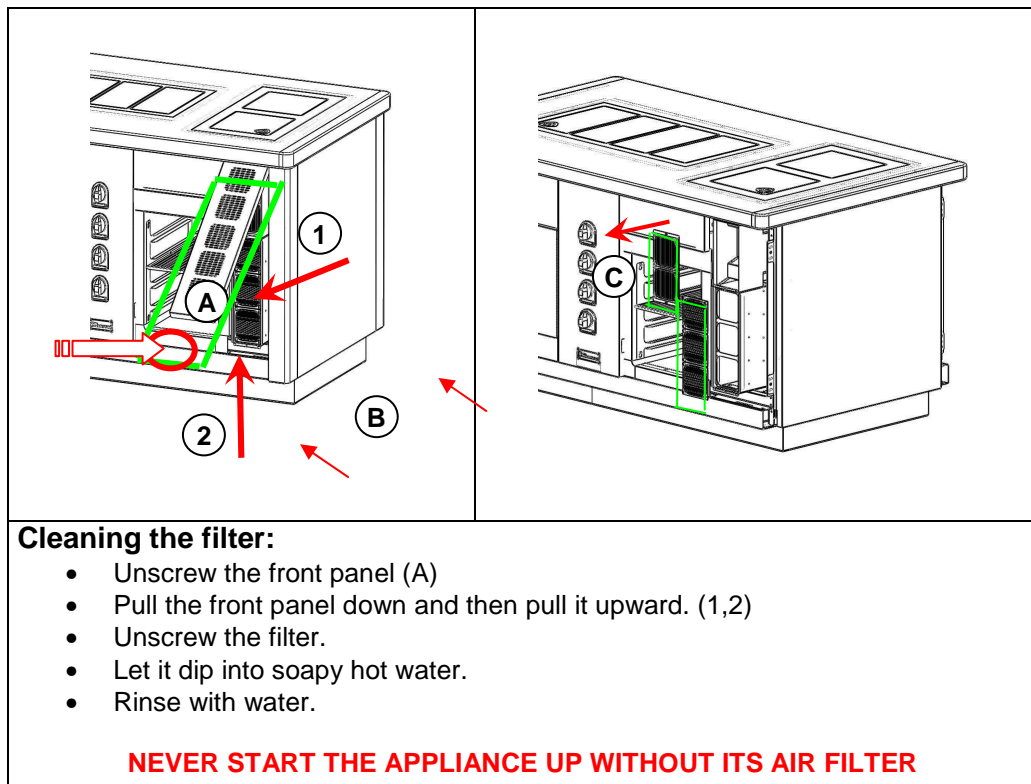

5.5. **Maintenance: mild steel base, oven shelf, shelf runners, electric oven and hot cupboard**

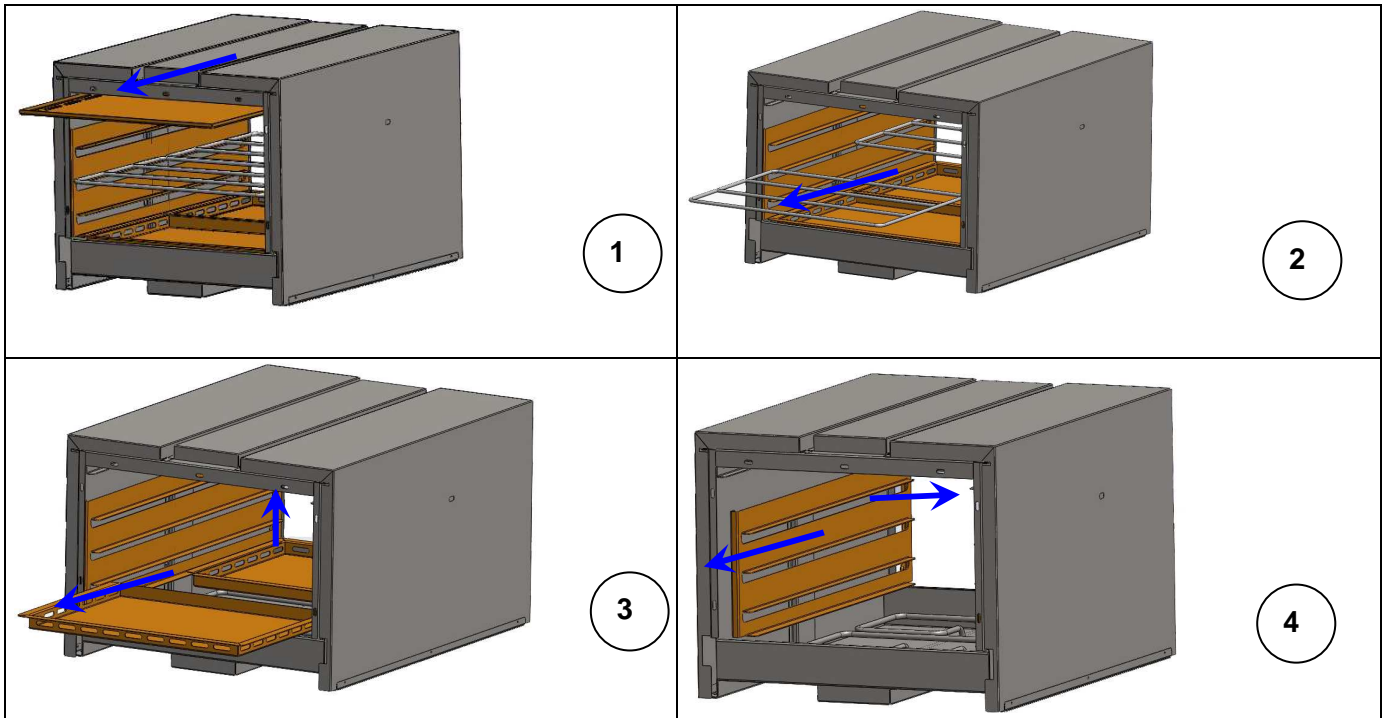

Cleaning the electric oven:

Open the oven door. Remove the enameled vaults from the oven (1).
 Remove the grids (2) and then the mild steel bases (3).
 Remove as well the enameled shelf runners. (4).
 Clean the parts in hot soapy water.

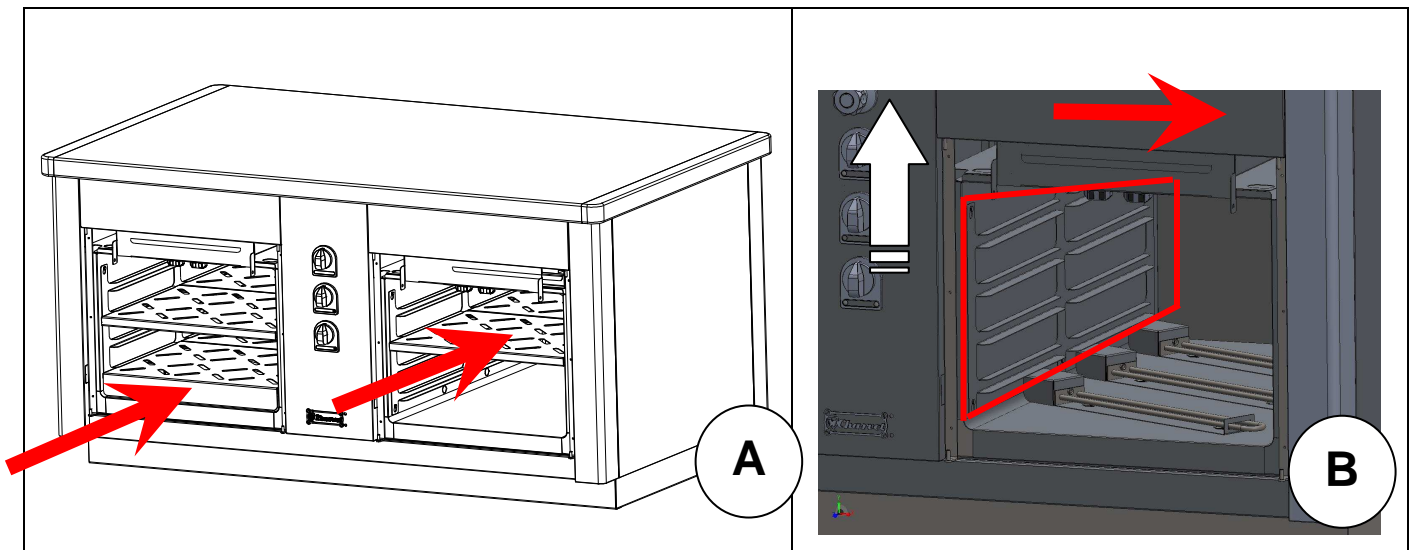

Cleaning the electric hot cupboard:

Open the door and remove the removable shelves (A).
 Push the removable runners up before pulling them to the left (B).
 Clean the parts in hot soapy water.

For best results, have your equipment serviced and cleaned on a regular basis by a qualified installer.

WARNING: Factory-sealed components must be serviced by neither installer nor user. Only a qualified electrician should replace the parts.

6. BREAKDOWN

Call for your installer to replace the faulty electric components in preparation for a next use.

Error Messages and Troubleshooting



Breakdown detected by the generator are indicated by the red and green indicators. The green indicator is dedicated to a certain type of breakdown depending on a predetermined cycle: A long ignition + code (= quantity of flashings between the long ignition cycles).

**Code: Quantity of flashings (1xlong+code)*

The red and green indicators are constantly alight:

Code*	Breakdown	Cause	Corrective action
1	Hardware current intensity	Unsuitable pan material OR faulty inductor	Use suitable pan material OR check inductor
3	Radiator temperature too high	Air routes blocked Fan clogged. Faulty inductor temperature probe	Clear air routes Clean fan, and replace probe
4	Cooking area temperature too high or too low	Pan is empty	Remove pan and switch off. Wait until it has cool down before replacing probe.
5			
6	Internal temperature too high or too low	Air routes blocked Fan clogged or faulty inductor temperature probe	Clear air routes or clean fan or replace probe
7			
8			
10			
11	Initialization error	Hardware initialization error	Wait for automatic updating (every 30 seconds about)
12			
13			
14			
15	Safety device	Empty pan or faulty probe	Remove pan, switch off and wait until cooking area has cool down. Replace probe if needed. Disconnect appliance, wait for a few minutes, and connect appliance again

Breakdown	Cause	Corrective action
Cooking area temperature too low	Unsuitable pan material A network phase is missing	Use suitable pan Check connection between appliance and network
Cooking area heats constantly at full power	Faulty switch	Check switch
Empty cooking area is heating	Faulty pan detection device	Make replace/repair generator
Hot small metal objects	Faulty pan detection device	Make replace/repair generator

The green indicator is briefly alight:

Breakdown	Cause	Corrective action
Cooking area does not heat	Pan detection diameter is less than 12 cm A network phase is missing	Use suitable pan Check connection between appliance and network

The indicators are unlit:



Breakdown	Cause	Corrective action
Appliance remains off	Faulty main current fuse / electric cable	Check connection between appliance and network
Fuses blow when powering on	Generator short-circuited	Replace/make replace generator
Cooking areas remain off	Faulty generator	Replace/make replace generator



Only a qualified electrician should replace the ignition transformers.

The manufacturer and the installer cannot be held responsible if the user neglects to ask for assistance in case of breakdown.

TRANSFER below information written on the data plate of your apparatus.

 CHARVET S.A. 38850 CHARAVINES	
Réf.	<input style="width: 100%;" type="text"/>
Code:	<input style="width: 50%;" type="text"/> Type: <input style="width: 50%;" type="text"/>
N°FC:	<input style="width: 50%;" type="text"/> <input style="width: 50%;" type="text"/>
N°OF:	<input style="width: 50%;" type="text"/> Rep. <input style="width: 50%;" type="text"/>
Cat.	<input style="width: 100%;" type="text"/>
Gaz	<input style="width: 100%;" type="text"/>
P (mbar)	<input style="width: 100%;" type="text"/>
ΣQ_n (kW)	<input style="width: 100%;" type="text"/>
ΣV_n (m ³ /h)	<input style="width: 100%;" type="text"/>
ΣM_n (kg/h)	<input style="width: 100%;" type="text"/>
U <input style="width: 50%;" type="text"/> V <input style="width: 50%;" type="text"/> Hz Ip <input style="width: 50%;" type="text"/>	
P <input style="width: 50%;" type="text"/> kW <input style="width: 50%;" type="text"/>	
 <input style="width: 100%; height: 20px;" type="text"/>	
MADE IN FRANCE	

This will help you with maintenance problems and spare parts.