

DESSUS NEUTRE SUR MESURE

PLACARD

DESCRIPTIF GÉNÉRAL

Chassis :
Chassis porteur en acier inox AISI 304, épaisseur 15 à 30/10, assemblé par soudures électriques haute intensité.

- Dessus :
Dessus (encadrement) en inox AISI 304, épaisseur 30/10, avec bord tombé avant de 55 mm et contrepli.

- Pieds :
Pieds hauteur 200 mm, en tube acier inox AISI 304, diamètre 60 mm avec embases réglables. (0 / + 30).

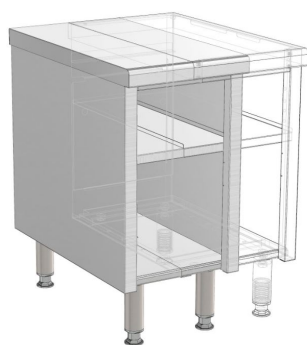

DESCRIPTIF DE L'APPAREIL

Dimensions (mm) : L 300 à 415 x P 800 x H 900.

- Dessus :
· Plan neutre inox AISI304.
- Soubassement :
· Baie libre fermée par 1 porte inox AISI304 (poignée inox et loqueteau magnétique) avec plancher en inox amovible.

Débit Gaz Nat G20/20 :	-
Débit Gaz Propane G31/37 :	-

RÉFÉRENCE : **1/2PLAC-SM/P**

CODE	DIMENSIONS	ALIMENTATION	PUISSANCE	POIDS
------	------------	--------------	-----------	-------

V01723	300/415 X 800 X 900 mm	-	-	-
---------------	------------------------	---	---	---













OPTIONS	CODE
---------	------

Tablette de dressage avancée 150 mm intégrée au dessus	V00805
Dos inox monté en usine	V01181
Plinthe inox clipsée sur pieds	V01186
-	-
-	-
-	-
-	-
-	-
-	-
-	-

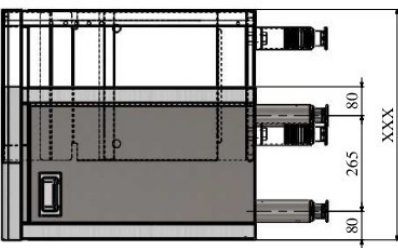
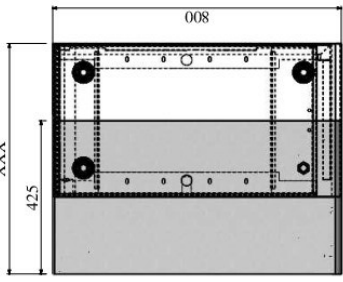
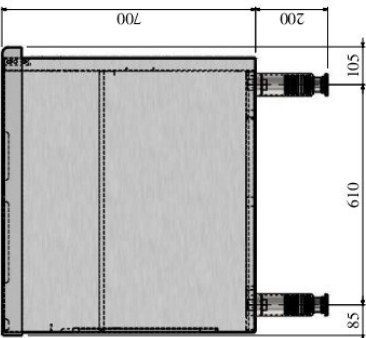
ACCESSOIRES	CODE
-------------	------

-	-
-	-
-	-



 <p>Connexion gaz Gas connection Gasanschluss Conexión gas</p>	 <p>Connexion électrique Electric connection Elektrische verbindung Conexión eléctrica</p>	 <p>Options Options Aufanlage Opciones</p>	 <p>Connexion eau froide Cold water connection Kaltwasseranschluss Conexión agua fra</p>	 <p>Connexion eau chaude Hot water connection Warmwasseranschluss Conexión agua caliente</p>	 <p>Connexion eau adoucie ≤ 3bars-1h...7°F Softened water connection ≤ 3bars-7°F Wasserzulauf (gefiltertes wasser ≤ bars-ab: 7 °GH) Conexión agua blanda ≤ 3 bars-1h...7°F</p>	 <p>Ecoulement eaux usées sewage outflow wasserablauf desagote</p>				
										    
<p>V01723 1/2 PRO 800 PLAC-SM/P</p>										

Charvet se réserve le droit de modifier les caractéristiques techniques de ses matériels sans préavis.

